

Product Catalog

Pressure and Temperature Measurement



- Mechanical Pressure
- Diaphragm Seals
- Mechanical Temperature
- Accessories



Part of your business



Product Catalog 900

Pressure and Temperature Measurement

Product Catalog 900

**Mechanical Pressure
Diaphragm Seals
Mechanical Temperature
Accessories**

Printed in the United States of America

 is a registered trademark of Underwriter's Laboratories.

 is a registered trademark of Underwriter's Laboratories.

XSELT™ is a registered trademark of WIKA Instrument Corporation.

Halocarbon® is a registered trademark of the Halocarbon Products Corporation.

Hastelloy® is a registered trademark of the Cabot family of companies.

Fluorolube® is a registered trademark of the Hooker Chemical & Plastics Corporation.

Monel® and Inconel® are registered trademarks of the INCO family of companies.

Viton® & Teflon® are registered trademarks of the E.I. DuPont family of companies.

Table of Contents

Selecting a Pressure Gauge	2	High Precision Gauges		MECHANICAL TEMPERATURE	
Chemical Compatibility Table	3	312.20 6"	58	Bimetal Thermometers	
Advantages of Liquid-filled Gauges	4	332.30 6"	59	Operating Principle	126
WIKA Type Numbers	5	332.54 4"	60	General Specifications	127
Ordering Guidelines for Pressure Gauges	6	332.34 4½"	61	TI.1005	128
		332.34DD 4½"	62	TI.ST	128
		332.25 / 312.25 4½"	63	TI.20	129
		342.11 10"	64	TI.T20/TI.T17	130
				TI.30/TI.50	131
				TI.31/TI.51	132
				TI.32/TI.52	133
				TI.33/TI.34/TI.53/TI.54	134
				Ordering Bimetal Thermometers	135
				Bimetal Thermometer Options	137
				Digital Thermometers	
				TI.80/TI.82	138
				Twin-Temp Thermometers	
				TT.30/TT.32/TT.50/TT.52	139
				TT.80/TT.82	143
				Gas Actuated Thermometers	
				TI.R45/TI.R60	146
				TI.TSG60	148
				Vapor Actuated Thermometers	
				TI.V20/TI.V25/TI.V35/TI.V45	150
				Industrial Glass Thermometers	
				TI.61102/TI.61104	152
				TI.62102/TI.62104	152
				TI.DO1	153
				TI.701/TI.901	153
				Thermowells	
				TW.TH / TW15 (Threaded)	159
				TW.FL / TW10 (Flanged)	160
				TW.SW / TW20 (Socket/Weld)	160
				TW.SC / TW30 (Sanitary)	161
				Industrial Glass	162
				ACCESSORIES	
				910.10 Gauge Cocks	163
				910.11 Needle Valves	164
				910.11.100 Mini-Needle Valves	165
				910.11.200 Block & Bleed Valves	166
				910.11.300 Multi-Port Valves	167
				910.12.100/910.12.200/	
				910.12.300 Snubbers	168
				910.13 Overpressure Protectors	169
				910.14.100 Test Port Plug	170
				910.14.200 Adaptors	170
				910.14.300 Couplings	171
				910.24 Mini-Siphon	171
				910.15.100/910.15.200 Siphons	172
				CP3000/CP4000 Alarm Contacts	173
				Socket Restrictor	176
				Drag Pointer	176
				Alarm Contacts	176
				Pressure Gauge Accessories	177
				Standard Dial Layouts	182
				Conversion Chart	184
				Cross reference Chart	IBC
MECHANICAL PRESSURE		Calibration Equipment			
Commercial Gauges		CPH-6600	65		
111.10 1½", 2", 2½", 4"	7	CPG 1000	66		
111.10SP - Fire Sprinkler 4"	8	WICP-L100, WICP-M500, WICP-H10K	67		
111.11 1½", 2", 2½"	9				
111.12 1½", 2", 2½", 4"	10				
111.16PM 1½", 2"	12				
111.25CT 4½"	13				
113.13 1½", 2½"	14				
113.53 1½"	15				
Industrial & Process Gauges		DIAPHRAGM SEALS			
131.11 1½", 2"	16	Diaphragm Seal Applications	69		
13X.53 4"	17	Operating Principle	70		
211.11 10"	18	Selection Guidelines	71		
212.20 6"	19	Assembled Seals			
213.40 2½", 4"	20	M93X.25	73		
21X.40PM 3½"	21	M93X.3A	74		
21X.53 2", 2½", 4"	22	M932.2C	76		
23X.53 2", 2½", 4"	26	M93X.D1	78		
21X.54 4"	28				
23X.54 2½", 4"	29	Threaded Seals			
233.55 2½"	32	990.TA	80		
23X.30 2½", 4"	33	990.TB	81		
23X.50 2½", 4", 4½", 6"	34	990.10	82		
21X.34 4½"	35	990.TC	84		
22X.34 4½"	36	990.40	86		
23X.34 4½", 6"	37	990.34	88		
26X.34 4½"	39	990.36	89		
232.34DD 4½"	40	Flanged Seals			
212.25 4½", 6"	41	990.12	90		
232.25 4½", 6"	42	990.FA	92		
4XX.12 4", 6"	43	990.FC	94		
43X.50 4", 6"	44	990.FD	96		
		990.FB	98		
		990.26	100		
		990.27	101		
		990.FR	103		
		990.28	105		
		990.41	106		
		Sanitary Seals			
		990.22	108		
		Plastic Seals			
		990.31	109		
		InLine Seals			
		981.10	110		
		981.27	112		
		981.31	114		
		981.22	115		
		Seal Accessories			
		910.27	116		
		910.ZA	117		
		General Seal Information	119		
Low Pressure Gauges					
A2G-10	45				
A2G-15	46				
611.10 2½"	47				
612.20 4"	48				
6X2.34 4½"	49				
632.50 4"	50				
Differential & Duplex Gauges					
700.04 2½", 4½"	51				
700.05 2½", 4½"	52				
712.15 6"	53				
712.25DP 4½", 6"	54				
712.25DX 4½", 6"	55				
732.25 4½", 6"	56				
732.26 4½", 6"	57				

For complete detailed information, including electronic pressure, electronic temperature and ultra high purity products, please visit www.wika.com.

Selecting a Pressure Gauge

When selecting a pressure gauge, it is important to consider the following factors to ensure safety and accuracy:

1. Pressure fluid composition
2. Pressure fluid temperature
3. Ambient conditions
4. Pressure range
5. Conditions affecting wear of the system
6. Method of mounting
7. Required accuracy

1. Pressure fluid composition

Since the sensing element of a pressure gauge may be exposed directly to the measured medium, consider the characteristics of this medium. It may be corrosive, it may solidify at various temperatures or it may contain solids that will leave deposits inside the sensing element. For pressure fluids that will not solidify under normal conditions or leave deposits, a Bourdon tube gauge is acceptable. Otherwise a Sealgauge or diaphragm seal should be used. A chemical compatibility chart follows this section to aid in the selection of the proper sensing element material.

2. Pressure fluid temperature

Steam and other hot media may raise the temperature of the gauge components above safe working limits of the sealed joints. In these cases it is recommended that a siphon, cooling tower or diaphragm seal be used in conjunction with the pressure gauge.

3. Ambient conditions

The normal ambient temperature range for WIKA pressure gauges is -40°F to +140°F (-40°C to +60°C) for dry or silicone-filled gauges and -4°F to +140°F (-20°C to +60°C) for glycerine-filled gauges. The error caused by temperature changes is +0.3% or -0.3% per 18°F rise or fall, respectively. The reference temperature is 70°F (20°C). The correction is for the temperature of the gauge, not the temperature of the measured medium.

Remote gauge mounting using a diaphragm seal and capillary line is one alternative for applications involving extreme ambient temperature.

Moisture and weather effects must also be considered. Liquid-filled gauges prevent condensation build up. For outdoor use, stainless steel, brass or plastic cased gauges are recommended.

4. Pressure range

A gauge range of twice the working pressure is generally selected. The working pressure in all cases should be limited to 75% of the gauge range. Where alternating pressure and pulsation are encountered, working pressure should be limited to 2/3 of the gauge range.

5. Conditions affecting wear of the system

In applications involving severe pressure fluctuation or pulsation, the use of restrictors and/or snubbers is recommended. In addition, liquid-filled gauges increase the service life of gauges in these conditions. WIKA liquid-filled gauges are generally filled with glycerine. Silicone for larger temperature extremes and Halocarbon® for use with oxidizing agents such as chlorine, oxygen and hydrogen peroxide are also available.

6. Method of mounting

Radial (LM) and back (CBM or LBM) connections are available for most WIKA gauges. WIKA stocks gauges with standard NPT threaded connections. Other types such as metric threads, straight threads, hose barbs and special fittings are available as a special order.

Pressure gauges should be mounted in the upright position. For applications where the gauge is mounted side ways, horizontally or upside down, contact WIKA Customer Service for gauge type compatibility.

7. Required accuracy

WIKA stocks gauges with accuracies from $\pm 3/2/3\%$ to $\pm 0.1\%$ of span (ASME Grade B to Grade 4A).

To ensure safe and accurate gauge selection, you must take all of the above factors into consideration. When in doubt, please do not hesitate to contact your local stocking distributor or WIKA Customer Care for assistance!

Chemical Compatibility Chart

Acetic Acid	B	Ethyl Acetate	A	Oxygen	A
Acetic Anhydride	D	Ethyl Cellulose	B	Paraffin	A
Acetone	B	Ethylene	A	Phosphoric Acid	B
Acetylene	B	Ethylene Dibromide	B	Photographic Solutions	B
Alcohol	A	Ethylene Dichloride	D	Pickling Solutions	B
Alums	B	Ethylene Glycol	A	Picric Acid	B
Aluminum Sulfate	B	Ferric Nitrate	B	Picric Acid (dry)	B
Ammonia	B	Ferric Sulfate	B	Potassium Chloride	D
Ammonium Carbonate	B	Formaldehyde	B	Potassium Cyanide	B
Ammonium Hydroxide	D	Freon	A	Potassium Permanganate	B
Ammonium Phosphate	D	Gallic Acid	B	Prestone	A
Beer	A	Gas (for lighting)	A	Salicylic Acid	A
Benzine	A	Gasoline	A	Sea Water	C
Benzol	A	Gasoline (refined)	B	Silver Nitrate	B
Benzyl Alcohol	B	Glucose	C	Sodium Carbonate	D
Bleach Liquors	B	Glycerine	A	Sodium Cyanide	D
Bordeaux Mixture	A	Hydrocyanic Acid	B	Sodium Hydroxide	D
Butane	B	Hydrogen	B	Sodium Nitrate	B
Butanol	A	Hydrogen Peroxide	B	Sodium Peroxide	B
Butyric Acid	B	Kerosene	A	Sodium Phosphate	B
Calcium Bisulfite	B	Lacquers	A	Sodium Sulfate	B
Calcium Chloride	C	Lactic Acid	B	Sodium Sulfide	D
Calcium Hydroxide	B	Lysol	B	Sodium Sulfite	B
Carbon Dioxide(dry)	B	Magnesium Hydroxide	C	Sulfur Dioxide	D
Carbon Bisulfide	B	Magnesium Sulfate	B	Sulfur Dioxide (dry)	B
Casein	B	Mercury	B	Sulfuric (75%)	B
Chloroform	B	Methyl Chloride	D	Sulfurous Acid	B
Chromic Acid	B	Methyl Salicylate	D	Tanning Liquors	D
Citric Acid	B	Naphtha	A	Toluene	A
Coal Gas	A	Nickel Acetate	B	Vegetable Oils	B
Copper Sulfate	B	Nitric Acid (pure)	B	Vinegar	B
Cottonseed Oil	B	Nitrous Acid	D	Water	A
Creosote (crude)	B	Nitrous Oxide	D	Whiskey	B
Dextrine	A	Oil (lubricating)	A	Wines	B
Ethers	D	Oil (refined)	A	Zinc Sulfate	B

NOTE: For steam service, a siphon is required.

Find the process fluid in the table above and match the letter code (A,B,C, or D) with the wetted part material listed below:

A = Brass (Copper Alloy) B = 316 SS C = Monel® D = Consult Factory

This table is provided as a reference only and is accurate to the best of WIKA's knowledge. WIKA assumes no responsibility for, or obligation from, the information here.

Advantages of Liquid-filled Gauges

Liquid-filled gauges

Liquid-filled pressure gauges provide a number of advantages:

- the liquid absorbs vibration and pressure spikes
- the dampening action of the liquid enables the operator to take readings during conditions of rapid dynamic loading and vibration
- the liquid lubricates all moving elements, dramatically reducing wear in the movement
- because most liquid-filled gauges are filled with non-aqueous liquid and hermetically sealed, they perform in corrosive environments and are immune to moisture penetration and icing, and shock effects are lessened

Liquid-filled gauges enhance the reliability and integrity of the measuring system for long periods under extreme operating conditions.

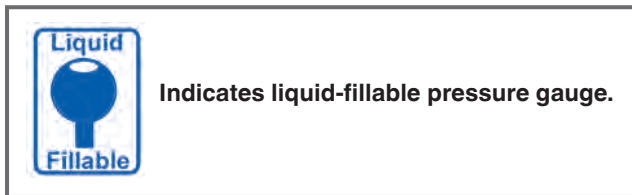

Liquid Fill Fluid

Ambient Temperature Ratings (Table A)

Allowable Operating Range - Temperature range in which the operation of the gauge is not adversely affected by the filling liquid. At temperatures above the maximum rating, the fluid may break down. At temperatures below the minimum rating, the fluid may solidify (freeze).



NOTE: Some parts of the pressure gauge may not be able to withstand temperatures above 140°F. Consult with the factory for technical assistance for these applications.

Liquid-filled Gauge Case Venting

For pressure gauges with full scale ranges of 300 psi and below (including vacuum and compound ranges of 30" Hg-0-200 psi and below), case venting (after the gauge is installed) is necessary to preserve the accuracy. Temperature fluctuations during shipment and in the process application cause the liquid filling to expand and contract which in turn increases or decreases case pressure. As a result, accuracy can be decreased and the pointer may not return to zero properly until the gauge is vented to the atmosphere.

To vent a WIKA gauge, move the valve to the open position which will release any pressure or vacuum built up in the case. If the gauge is installed in an upright position, the lever can be left in the open position. The lever allows the use of a gauge in a non-upright orientation.



Vent Plug

Choose the Right Liquid

The type of liquid used to fill the gauge varies with the application. Although pure glycerine provides the best performance in most applications, each has its own requirements. Guidelines to help ensure that a fluid is properly matched to an application are:

- if icing is a problem, use gauges filled with silicone oil or other comparable liquids. They have low viscosities even at -60°C
- if the system has electric accessories, such as contacts, use insulating oils, and
- if extreme temperature fluctuations are expected, use silicone oils

The higher the liquid viscosity, the greater its dampening capacity. The reason for this is that dampening changes in proportion to the temperature-dependent viscosity of the filling liquid. The suitable degree of dampening depends on the operating requirements the gauge must meet, such as pointer response time, pressure extremes, vibration and changes in pressure. WIKA can recommend specific liquids to suit problem applications.

Fill Fluid	Allowable Operating Range
Glycerine Dow 99.7% USP, Synthetic 1118 Centistokes at 68°F	-4°F to 140°F -20°C to 60°C
Silicone Dow Corning 200 Fluid 1000 Centistokes at 77°F	-40°F to 140°F -40°C to 60°C
Halocarbon® Halocarbon® Products 6.3 Centistokes at 100°F	-40°F to 140°F -40°C to 60°C

Table A - Allowable Ambient Temperature Ratings

WIKA Type Numbers

The following is a guide to the WIKA model numbering system.

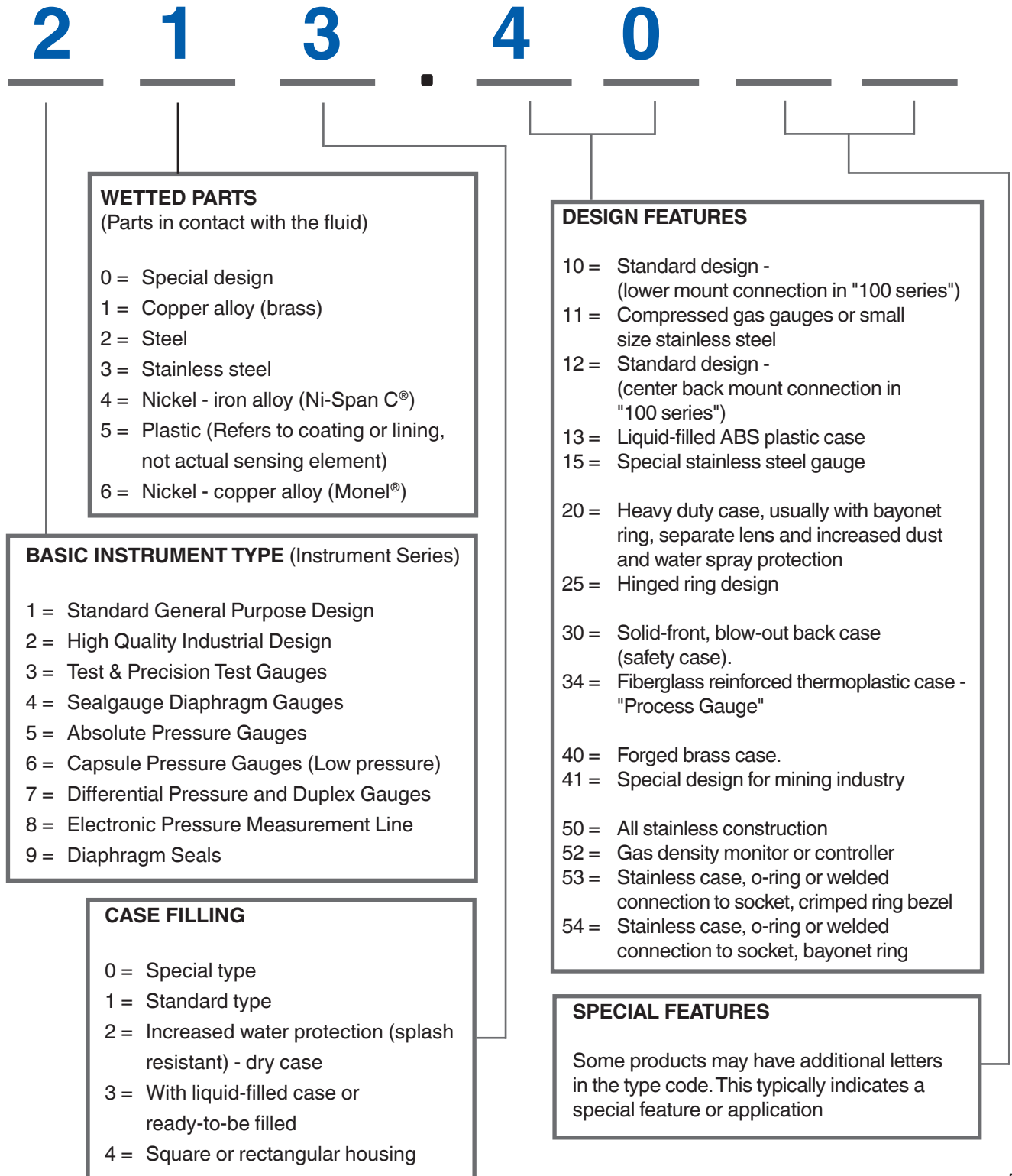

Ordering Guidelines for Pressure Gauges

1) Quick Order 7- or 8-Digit Part Numbers:

Example: 9834850

Use the part number for the instrument you wish to order.

If you need additional options, or don't see a part number referenced for the exact product you need, you may use Descriptive Text as indicated below (see #2). **A 7-or 8-digit part number will be provided with your order confirmation.** The part number provided may then be used for re-ordering purposes.

2) Descriptive Text Part Number System:

Example:

Standard Product Description Section				Additional Options & Accessories	
232.34	4.5	100 psi	1/2"	LM	SG, PM
(Type #)	(Dial Size)	(Pressure Range)	(Process Conn. & Location)		(Additional Options / Accessories)

The above example would indicate a 4 1/2" process gauge, dry, 100 psi dial scale, 1/2" NPT connection, lower mount connection with the following selected options: safety glass (SG) and panel mount (PM), as indicated.

- Descriptive text can be used anytime you do not find an exact item with a listed part number. You may add as many codes at the end of the descriptive text as is required to configure the product.
- Codes and installed prices are found on a selection chart for each product type. Additional options may be located on the Accessory pages section in the back of the Catalog 900.
- Please reference the WIKA Type Number (pg. 5) for additional product type information. WIKA product types may already determine many configurations for wetted parts and case fill.
- Options and accessories should always appear at the end of the descriptive text, separated by commas. If you are not sure what to use for abbreviated code, then simply spell it out.

NOTE: If you provide a part number and descriptive text, we will use the part number only.

If you are unclear, do not see the option(s) needed, or require ordering assistance, please contact a WIKA Customer Care or Technical Quote Team representative.

Type 111.10

WIKA type 111.10 standard pressure gauges are designed for long and reliable service under rugged conditions. Some typical applications are for pumps, hydraulic and pneumatic systems, compressors, as a contractor's gauge and for many other applications where the measured media does not corrode brass.



MECHANICAL PRESSURE

Standard Features

Size:	1½", 2", 2½" & 4"	Accuracy:	± 3/2/3% of span
Case:	Black ABS		ASME B40.100 Grade B
Wetted Parts:	Copper alloy	Connection:	Lower mount
Window:	Clear plastic		
Dial:	White ABS; (4") aluminum		
Pointer:	Black ABS; (4") aluminum		

Type	111.10							
Size	1½"		2"		2½"		4"	
Connection	LM		LM		LM		LM	
Conn. Size	1/8" NPT	1/8" NPT	1/4" NPT		1/4" NPT		1/4" NPT	
Press. Scale	PSI	PSI	PSI	PSI/KPA	PSI	PSI/KPA	PSI	PSI/KPA
30" Hg	9747214	8990039	4252901	8990250	4253027	8990471	4255900	9767991
30"-0-15 psi					4253035	8990489	4255918	9768009
30"-0-30 psi					4253043	8990497	4255926	9768017
30"-0-60 psi					4253051	8990501	4255934	9768025
30"-0-100 psi					4253060	8990519	4255942	9768033
30"-0-160 psi					4253078	8990527	4255951	9768041
30"-0-200 psi					4253086	8990535	4255969	9768050
15 psi	9747222	8990102	4252919	8990323	4253108	8990552	4255977	9768068
30 psi	9747230	8990110	4252927	8990331	4253116	8990560	4255985	9768076
60 psi	9747249	8990128	4252935	8990349	4253124	8990578	4255993	9768084
100 psi	9747257	8990136	4252943	8990357	4253132	8990586	4256000	9768092
160 psi	9747265	8990145	4252951	8990365	4253141	8990595	4256018	9768106
200 psi	9747273	8990153	4252960	8990374	4253159	8990608	4256026	9768114
300 psi		8990161	4252978	8990382	4253167	8990616	4256034	9768122
400 psi			4252986		4253175	8990625	4256042	9768130
600 psi			4252994		4253183	8990633	4256051	9768149
800 psi					4253191	8990641	4256060	
1,000 psi			4253001		4253205	8990659	4256078	9768416
1,500 psi					4253213	8990667	4256086	
2,000 psi					4253221	8990675	4256094	
3,000 psi			4253019		4253230	8990684	4256107	
5,000 psi					4253248	8990692	4256115	
Accessory order codes (installed at factory)								
Restrictor	+ R							

Stock items shown in blue print.

Available Options

- Glass window
- Drag pointer
- Cleaned for oxygen service
- Black steel case and ring
- Stainless steel case and ring
- Special connections

Applications

- Fire sprinkler systems
- Suitable for all media that will not obstruct the pressure system or attack copper alloy parts

Abbreviations
LM - Lower mount

Type 111.10SP

WIKA type 111.10SP 4" gauges are specifically designed for fire sprinkler service. This gauge features a black polycarbonate case, polycarbonate window and brass wetted parts. They are UL and FM approved for fire sprinkler service and have a standard accuracy of $\pm 3/2/3\%$ of span.



Standard Features

Size:	4"	Accuracy:	$\pm 3/2/3\%$ of span
Case:	Black polycarbonate		ASME B40.100 Grade B
Wetted Parts:	Copper alloy	Connection:	Lower mount
Window:	Snap-in polycarbonate		
Dial:	White aluminum		
Pointer:	Black aluminum		

Type	111.10SP
Size	4"
Connection	LM
Conn. Size	1/4" NPT
Press. Scale	PSI
300 psi "WATER"	4233761
80 psi rated to 250 psi "AIR"	4233779
Accessory order codes (installed at factory)	
Restrictor	+ R

Stock items shown in blue print.

Available Options

- Black steel case

UL-393 Listed



Factory Mutual Approved



Abbreviations

LM - Lower mount

Type 111.11

WIKA type 111.11 gauges are designed for use with compressed gases, such as those used in the welding industry. The low copper content of the Bourdon tube for pressure ranges 800 psi and below makes it safe for use with acetylene. All type 111.11 gauges are cleaned to ASME B40.100 Level IV. "USE NO OIL" is printed in red on the face of each dial, making them safe for use with oxygen.



Standard Features

Size:	1½", 2" & 2½"	Pointer:	Black aluminum
Case:	Polished brass or gold-painted steel	Accuracy:	± 3/2/3% of span ASME B40.100 Grade B
Wetted Parts:	Copper alloy	Connection:	Lower mount
Window:	Twist-lock polycarbonate		
Dial:	White aluminum	Ranges 100 psi and up supplied with restrictor	

Type	111.11				
Size	1½"	2"	2½"	2"	2½"
Case	Gold-painted steel			Polished brass	
Conn. Size	1/8" NPT	1/4" NPT		1/4" NPT	
Press. Scale	PSI	PSI	PSI	PSI	PSI
15 psi					
30 psi				8611009	8610851
30 psi Red Band	8079633	8985025	8985030	8611017	8610860
60 psi				8611025	8610878
100 psi	8079650	8985026	8985031	8611033	8610886
200 psi		8985027	8985032	8611041	8610894
400 psi	9735232	8985028	8985033	8611050	8610908
600 psi				8611076	8610924
1,000 psi				8611084	8610932
1,500 psi					
2,000 psi				8611106	8610959
3,000 psi				8611122	8610967
4,000 psi	8079617	8985029	8985034	8611114	8610975
6,000 psi	N/A				
Accessory order codes (installed at factory)					
Restrictor			+ R		

Stock items shown in blue print.

Available Options

- Restrictor
- Cleaned for oxygen service with bag and cap
- CBM connection (1½" and 2" only)
- Black steel case
- Chrome plated steel case
- Black plastic case (1½" and 2" only)

Applications

- Compressed gas regulators
- Beverage dispensing machines
- Suitable for all media that will not obstruct the pressure system or attack copper alloy parts

Abbreviations

LM - Lower mount
CBM - Center back mount

Type 111.12

WIKA type 111.12 gauges feature a black plastic case, snap-in plastic window and a center back mount (CBM) rear connection. With an industry recognized ASME 3/2/3% of span accuracy, WIKA type 111.12 gauges are the industry standard in the commercial gauge line. Available in a variety of sizes, mounting styles and optional configurations, type 111.12 gauges are suitable for many tough applications including regulators, medical, pneumatic controllers, compressors, valve positioners and pumps.



Standard Features

Size:	1½", 2", 2½" & 4"	Accuracy:	± 3/2/3% of span
Case:	Black ABS		ASME B40.100 Grade B
Wetted Parts:	Copper alloy	Connection:	Center back mount
Window:	Clear plastic		
Dial:	White ABS; (4") aluminum		
Pointer:	Black ABS; (4") aluminum		

Type	111.12				
	1½"		2"		
Size					
Connection	CBM				
Conn. Size	1/8" NPT		1/8" NPT	1/4" NPT	
Press. Scale ¹	PSI	PSI/KG/CM ²	PSI	PSI	PSI/KPA
30" Hg	9690128	9692635	9690357	4253256	9690586
30"-0-15 psi					
30"-0-30 psi					
30"-0-60 psi					
30"-0-100 psi					
30"-0-160 psi					
30"-0-200 psi					
30"-0-300 psi					
30"-0-400 psi					
15 psi	9690209	9692644	9690438	4253264	9690667
30 psi	9690217	9691923	9690446	4253272	9690675
60 psi	9690225	9692652	9690455	4253281	9690684
100 psi	9690234	9692660	9690463	4253290	9690692
160 psi	9690242	9692678	9690471	4253302	9690705
200 psi	9690250	9692686	9690489	4253311	9690714
300 psi			9690497	4253329	9690722
400 psi				4253337	
600 psi				4253345	
800 psi					
1,000 psi				4253353	
1,500 psi					
2,000 psi					
3,000 psi				4253361	
5,000 psi					
Accessory order codes (installed at factory)					
Front flange, black steel	--			FF B	
Front flange, chr steel	--			FF C	
Restrictor, brass			R		

Available Options

- Glass window
- Drag pointer
- Cleaned for oxygen service
- Black steel case and ring
- Stainless steel case and ring
- Special connections

Applications

- Hydraulic and pneumatic systems
- Pumps, compressors, water systems, regulators
- Suitable for all media that will not obstruct the pressure system or attack copper alloy parts

Abbreviations

CBM - Center back mount

Stock items shown in blue print.

Type 111.12

Type	111.12		
Size	2½"		4"
Connection	CBM		CBM
Conn. Size	1/4" NPT		1/4" NPT
Press. Scale ¹	PSI	PSI/KPA	PSI/KG/CM ²
30" Hg	4253371	9691035	
30"-0-15 psi	4253389	9691044	
30"-0-30 psi	4253397	9691052	
30"-0-60 psi	4253400	9691060	
30"-0-100 psi	4253418	9691078	
30"-0-160 psi	4253426	9691086	
30"-0-200 psi	4253434	9691095	
30"-0-300 psi			
30"-0-400 psi			
15 psi	4253451	9691116	9693577
30 psi	4253460	9691125	9693585
60 psi	4253478	9691133	9693594
100 psi	4253486	9691141	9693607
160 psi	4253494	9691159	9693615
200 psi	4253507	9691167	9693624
300 psi	4253515	9691175	9693632
400 psi	4253523	9691184	9693640
600 psi	4253531	9691192	9693658
800 psi	4253541	9691205	
1,000 psi	4253559	9691214	
1,500 psi	4253567	9691222	
2,000 psi	4253575	9691230	
3,000 psi	4253583	9691248	
5,000 psi	4253591	9691256	
Accessories (installed)			
Front flange, black steel	FF B		
Front flange, chrome steel	FF C		
Restrictor, brass	R		

¹ "PSI/KG/CM²" denotes dual scale; PSI outside in black, KG/CM² inside in red.
 Vacuum scale: 30"Hg outside in black; 760 mm Hg inside in red.

Abbreviations
 CBM - Center back mount

Stock items shown in **blue print**.

Type 111.16PM

WIKA type 111.16PM gauges are designed for U-clamp panel mounting. They feature a black ABS case and low friction Swiss movement to insure a long, reliable service life. The 111.16PM design fits into U.S. size panel cut-outs.



Standard Features

Size:	1½" & 2"	Pointer:	Black ABS
Case:	Black ABS	Accuracy:	± 3/2/3% of span ASME B40.100 Grade B
Wetted Parts:	Copper alloy	Connection:	Center back mount, with U-clamp
Window:	Clear plastic		
Dial:	White ABS		

Type	111.16PM		
Size	1½"	2"	
Connection	CBM/UC	CBM/UC	
Conn. Size	1/8" NPT	1/4" NPT	1/4" NPT
Press. Scale	PSI	PSI	PSI/KPA
30" Hg	4231279	4231341	4231422
30"-0-15 psi			
30"-0-30 psi			
30"-0-60 psi			
30"-0-100 psi			
30"-0-160 psi			
30"-0-200 psi			
15 psi	4231287	4231350	4231431
30 psi	4231295	4231368	4231449
60 psi	4231309	4231376	4231457
100 psi	4231317	4231384	4231465
160 psi	4231325	4231392	4231473
200 psi	4231333	4231406	4231481
300 psi		4231414	4231490
400 psi			
600 psi			
800 psi			
1,000 psi			
1,500 psi			
2,000 psi			
3,000 psi			
5,000 psi			
Accessory order codes (installed at factory)			
Restrictor		+ R	

Available Options

- Restrictor
- Cleaned for oxygen service
- Special connections

Applications

- Pneumatics
- HVAC
- Suitable for all media that will not obstruct the pressure system or attack copper alloy parts

Abbreviations

CBM - Center back mount
UC - U-clamp

Stock items shown in blue print.

Type 111.25CT

WIKA type 111.25CT 4½" gauges are specifically designed for the HVAC market as a contractor's gauge. This gauge features a stainless steel case, brass wetted parts, and an adjustable pointer. Contractor's gauges are designed for static applications and may not be well-suited to high vibration and pulsation applications.



MECHANICAL PRESSURE

Standard Features

- | | | | |
|----------------------|-------------------------------|--------------------|----------------------------|
| Size: | 4½" | Pointer: | Black aluminum, adjustable |
| Case: | Stainless steel, matte-finish | Accuracy: | ± 1% of span |
| Wetted Parts: | Copper alloy | | ASME B40.100 Grade 1A |
| Window: | Snap-in polycarbonate | Connection: | Lower mount |
| Dial: | White aluminum | | |

Type	111.25CT	
Size	4½"	
Connection	LM	
Conn. Size	1/4" NPT	
Press. Scale	PSI	PSI/KPA
30" Hg		
30"-0-15 psi	4277687	4277849
30"-0-30 psi	4277695	4277857
30"-0-60 psi	4277709	4277865
30"-0-100 psi	4277717	4277873
30"-0-160 psi	4277725	4277881
30"-0-200 psi	4277733	4277890
30"-0-300 psi	4277741	4277903
30"-0-400 psi		
15 psi	4277750	4277911
30 psi	4277768	4277920
60 psi	4277776	4277938
100 psi	4277784	4277946
160 psi	4277792	4277954
200 psi	4277806	4277962
300 psi	4277814	4277971
400 psi	4277822	4277989
600 psi	4277831	4277997
Accessory order codes (installed at factory)		
Rear flange, SS	+ RF	
Restrictor	+ R	

Available Options

- Cleaned for oxygen service
- Special connections
- Restrictor
- Stainless steel case with rear flange
- Black steel case

Abbreviations

LM - Lower mount
 SS - Stainless steel

Stock items shown in blue print.

Type 113.13

The WIKA type 113.13 gauge is the ideal choice for OEM and general industrial applications requiring an economical, liquid-filled pressure gauge. The glycerine liquid fill dampens the Bourdon tube and reduces wear of the movement, extending gauge life. Typical applications of the type 113.13 include air compressors, hydraulic presses, pumps, marine engines, as well as other types of industrial hydraulic and pneumatic equipment.



Standard Features

Size:	1½" & 2½"	Accuracy:	± 3/2/3% of span
Case:	Black ABS		ASME B40.100 Grade B
Wetted Parts:	Copper alloy	Connection:	Lower or center back mount (1½" CBM only)
Window:	Clear plastic	Liquid Fill:	Glycerine
Dial:	White ABS		
Pointer:	Black ABS		

Type	113.13		
Size	1½"	2½"	
Connection	CBM	LM	CBM
Conn. Size	1/8" NPT	1/4" NPT	
Press. Scale	PSI	PSI	PSI
30" Hg		9677909	9693289
30"-0-15 psi		9677925	
30"-0-30 psi		9677933	
30"-0-60 psi		9677941	
30"-0-100 psi		9677950	
30"-0-160 psi		9677968	
30"-0-200 psi		9677976	9693351
15 psi		9677984	9693360
30 psi	9738240	9677992	9693378
60 psi	9738258	9678000	9693386
100 psi	9738266	9678018	9693394
160 psi	9738274	9693726	9693408
200 psi		9693734	9693416
300 psi		9693742	9693424
400 psi		9693750	9693432
600 psi			
800 psi			
1,000 psi		9693777	9693459
1,500 psi		9693785	9693467
2,000 psi		9693793	9693475
3,000 psi		9693807	9693483
5,000 psi		9693815	9693491
Accessory order codes (installed at factory)			
Front flange, ABS	--	--	+ FF
UC, steel	--	--	+ UC
Restrictor		+ R	

Available Options

- Restrictor
- Other connections
- 2" case size (LM & CBM)

Abbreviations

LM - Lower mount
 CBM - Center back mount
 UC - U-clamp

Stock items shown in blue print.

Type 113.53

WIKA type 113.53 features a 1½" size liquid-filled gauge with a stainless steel case. The glycerine case fill dampens and lubricates the gauge internals, extending the life of the gauge. The 113.53 gauge is ideal for applications with high dynamic pressure pulsations and vibrations.



MECHANICAL PRESSURE

Standard Features

Size:	1½"	Pointer:	Black aluminum
Case:	Stainless steel, matte-finish	Accuracy:	± 3/2/3% of span
Wetted Parts:	Copper alloy		per ASME B40.100 Grade B
Window:	Clear plastic		
Dial:	White aluminum		

Type	113.53		
Size	1½"		
Connection	LM	CBM	CBM/UC
Conn. Size	1/8" NPT		
Press. Scale¹	PSI	PSI	PSI
30" Hg	50702424	50701525	50700821
30"-0-15 psi	50702432	50701533	50700847
30"-0-30 psi	50702441	50701541	50700855
30"-0-60 psi	50702459	50701550	50700863
30"-0-100 psi	50702467	50701568	50700871
30"-0-160 psi	50702475	50701576	50700880
30"-0-200 psi	50702483	50701584	50700898
30"-0-300 psi			
30"-0-400 psi			
15 psi	50702491	50701592	50700901
30 psi	50702505	50701606	50700910
60 psi	50702513	50701614	50700928
100 psi	50702521	50701622	50700936
160 psi	50702530	50701631	50700944
200 psi	50702548	50701649	50700952
300 psi	50702556	50701657	50700961
400 psi	50702564	50701665	50700979
600 psi	50702572	50701673	50700987
800 psi			
1,000 psi	50702581	50701681	50700995
1,500 psi	50702599	50701690	50701002
2,000 psi	50702602	50701703	50701011
3,000 psi	50702611	50701711	50701029
5,000 psi	50702629	50701720	50701061
Accessory order codes (installed at factory)			
Restrictor	R		
Silicone case fill	SIL		

Available Options

- Other pressure connections
- U-clamp bracket for panel mounting (CBM only)
- Restrictor
- Alternate case fills

Note: For options not shown - consult your WIKA distributor or the factory.

Abbreviations

- LM - Lower mount
- CBM - Center back mount
- SS - Stainless steel

Stock items shown in blue print.

Type 131.11

Type 131.11 gauges feature 316 SS wetted parts, a 304 SS case, and a snap-in, acrylic window. When installation space is limited and stainless steel wetted parts are needed, WIKA type 131.11 is the best choice. The stainless steel construction also makes these gauges ideal for harsh environments.



Standard Features

Size:	1½" & 2"	Pointer:	Black aluminum
Case:	304 SS, matte-finish	Accuracy:	± 2.5% of span
Wetted Parts:	316L SS	Connection:	Lower or center back mount
Window:	Snap-in polycarbonate		
Dial:	White aluminum		

Type	131.11					
	1½"		2"			
Size	1½"		2"			
Connection	LM	CBM	LM	CBM	LM	CBM
Conn. Size	1/8" NPT		1/8" NPT		1/4" NPT	
Press. Scale ¹	PSI	PSI	PSI	PSI	PSI	PSI
30" Hg						
30"-0-15 psi					8993241	8993259
30"-0-30 psi						
30"-0-60 psi					8993267	8993275
30"-0-100 psi					8993284	8993292
30"-0-160 psi					8993305	8993314
30"-0-200 psi						
15 psi						
30 psi	9117946	9118128	9118063	9117970	9118039	9117903
60 psi	9117938	9118101	9118071	9117989	9118020	9117890
100 psi	9117920	9118098	9118055	9117962	9118012	9117881
160 psi	9117911	9118080	9118047	9117954	9117997	9117865
200 psi						
300 psi						
400 psi						
600 psi						
800 psi						8993330
1,000 psi						
1,500 psi						
2,000 psi						
3,000 psi					8993348	8993356
5,000 psi						
10,000 psi						
Accessory order codes (installed at factory)						
Restrictor						+ R

Stock items shown in blue print.

Available Options

- Restrictor
- 2½" case size
- U-clamp bracket
- Front or rear flange
- Instrument glass window
- Cleaned for oxygen service
- Other connections

Applications

- Suitable for corrosive environments and gaseous or liquid media that will not obstruct the pressure system
- Ideal when a smaller size instrument is needed
- CDA (Clean Dry Air) applications

Abbreviations

LM - Lower mount
 CBM - Center back mount
 SS - Stainless steel

Type 13X.53

Type 13X.53 stainless steel gauges provide resistance to corrosive media and environments. They feature 316 SS wetted parts, series 300 SS case and movement, and a welded case-to-socket connection. Type 132.53 gauges are field liquid fillable or available filled from the factory. This gauge is designed for static applications and may not be well-suited to high vibration and pulsation applications.



MECHANICAL PRESSURE

Standard Features

Size:	4"	Accuracy:	± 3/2/3% of span
Case:	304 SS		ASME B40.100 Grade B
Wetted Parts:	316L SS	Connection:	Lower mount
Window:	Polycarbonate		
Dial:	White aluminum		
Pointer:	Black aluminum		

Type	132.53	
Size	4"	
Connection	LM	
Conn. Size	1/4" NPT	1/2" NPT
Press. Scale	PSI	PSI
30 psi	4285329	4285477
60 psi	4285337	4285485
100 psi	4285345	4285493
160 psi	4285353	4285507
200 psi	4285361	4285515
300 psi	4285370	4285523
400 psi	4285388	4285531
600 psi	4285396	4285540
800 psi		
1,000 psi	4285400	4285558
1,500 psi	4285418	4285566
2,000 psi	4285426	4285574
3,000 psi	4285434	4285582
5,000 psi	4285442	4285591
10,000 psi	4285451	4285604
15,000 psi	4285469	4285612
Accessory order codes (installed at factory)		
Rear flange, SS	+ RF	
Restrictor	+ R	
Glycerine fill	Type 133.53	

Available Options

- Cleaned for oxygen service
- Other connections
- Restrictor
- Special connections
- Case fillings

Applications

- With liquid-filled case for applications with high dynamic pressure pulsations or vibration
- Suitable for corrosive environments and gaseous or liquid media that will not obstruct the pressure system
- Process industry: chemical/petrochemical, power stations, mining, on and offshore, environmental technology, mechanical engineering and plant construction

Abbreviations

LM - Lower mount
 SS - Stainless steel

Stock items shown in **blue print**.

Type 211.11

Type 211.11 10" pressure gauge is ideal for boiler room service or other applications where its large dial size makes it easier to read from a distance. These gauges feature a black-painted steel case and a $\pm 1.0\%$ accuracy.



Standard Features

Size:	10"	Pointer:	Black aluminum, adjustable
Case:	Black-painted steel	Accuracy:	$\pm 1\%$ of span
Ring:	Back-painted steel		ASME B40.100 Grade 1A
Wetted Parts:	Copper alloy	Connection:	Lower mount
Window:	Flat instrument glass		
Dial:	White aluminum		

Type	211.11
Size	10"
Connection	LM
Conn. Size	1/2" NPT
Press. Scale	PSI/BAR
30" Hg	
30"-0-15 psi	
30"-0-30 psi	
30"-0-60 psi	
30"-0-100 psi	
30"-0-160 psi	
30"-0-200 psi	
15 psi	
30 psi	4273193
60 psi	
100 psi	4273214
160 psi	
200 psi	4273231
300 psi	4273240
400 psi	4273258
600 psi	4273266
800 psi	4273274
1,000 psi	4273282
1,500 psi	
2,000 psi	4273303
3,000 psi	50081799
5,000 psi	4273321
10,000 psi	
15,000 psi	
Accessory order codes	
Rear flange	+ RF
Restrictor	+ R

Available Options

- Lower back mount connection
- 316 SS wetted parts (Type 231.11)
- Cleaned for oxygen service
- Special connections

Applications

- For plants and equipment where measured values must be read from a distance
- Suitable for gaseous or liquid media that will not obstruct the pressure system

Abbreviations

LM - Lower mount
SS - Stainless steel

Stock items shown in blue print.

Type 212.20

Designed for severe industrial service, WIKA type 212.20 gauges provide proven service life of an industrial gauge. The large dial size makes it ideal for applications requiring reading from a distance.



Standard Features

Size:	6"	Pointer:	Black aluminum
Case:	304 SS	Accuracy:	± 1% of span
Ring:	304 SS, bayonet-type		ASME B40.100 Grade 1A
Wetted Parts:	Copper alloy	Connection:	Lower mount
Window:	Flat instrument glass		
Dial:	White aluminum		

Type	212.20
Size	6"
Connection	LM
Conn. Size	1/2" NPT
Press. Scale	PSI
30" Hg	4287836
30"-0-15 psi	
30"-0-30 psi	4287844
30"-0-60 psi	
30"-0-100 psi	
30"-0-160 psi	
30"-0-200 psi	
15 psi	4287852
30 psi	4287861
60 psi	4287879
100 psi	4287887
160 psi	4287895
200 psi	4287909
300 psi	4287917
400 psi	4287925
600 psi	4287933
800 psi	
1,000 psi	4287941
1,500 psi	4287950
2,000 psi	4287968
3,000 psi	4287976
5,000 psi	4287984
10,000 psi	4287992
15,000 psi	4288000
Accessory order codes (installed)	
Rear flange	+ RF
Restrictor	+ R

Available Options

- Lower back mount connection
- Safety glass window
- Adjustable pointer
- Drag pointer (maximum reading indicator)
- Cleaned for oxygen service
- Magnetic or inductive contact switches
- Special connections

Applications

- Sturdy industrial pressure gauges designed in compliance with operational safety requirements of EN 837-1 and ASME B40.100
- Reliable pressure gauge for machine and plant construction industry
- Suitable for gaseous or liquid media that will not obstruct the pressure system or corrode copper alloy wetted parts

Abbreviations
 LM - Lower mount
 SS - Stainless steel

Stock items shown in blue print.

Mechanical Pressure > Industrial Gauges > 213.40

Type 213.40

This type 213.40 gauge features an integral Bourdon tube which is soldered or brazed directly into the one-piece case/socket.

Applications

- Intended for adverse service conditions where pulsation or vibration exists
- Suitable for gaseous or liquid media that will not obstruct the pressure
- Hydraulics and compressors

Standard Features

Size:	2½" & 4"	Pointer:	Black aluminum
Case:	Forged brass, gold-painted	Accuracy:	(2½") ± 2/12% of span
Ring:	(2½") Gold-plated ABS (4") Chrome-plated brass		ASME B40.100 Grade A (4) ± 1% of span
Wetted Parts:	Copper alloy		ASME B40.100 Grade 1A
Window:	Acrylic	Connection:	Lower or back mount
Dial:	White aluminum	Liquid Fill:	Glycerine



Available Options

- Safety glass window
- Pressure compensating window
- Drag pointer (max. reading indicator)
- Special connections

Type	213.40					
Size	2½"					
Connection	LM			CBM		
Conn. Size	1/4" NPT					
Press. Scale	PSI	PSI/KPA	PSI/BAR	PSI	PSI/KPA	PSI/BAR
30" Hg	9318003	9456198	9734109	9318070	9455930	9764312
30"-0-15 psi	9318011	9613862		9318089	9325662	
30"-0-30 psi	9318020	9456163		9318097	9325689	
30"-0-60 psi	9318038	9456201		9318100	9325816	
30"-0-100 psi	9318046	9679928		9318119	9149872	
30"-0-160 psi	9318054	9679936		9318127	9325972	
30"-0-200 psi	9318062	9442863		9318135	9326251	
15 psi	9310673	9456155	9734117	9318143	9455949	9734215
30 psi	9310681	9456171	9734125	9318151	9455957	9734223
60 psi	9310690	9456210	9734134	9318160	9455965	9734231
100 psi	9310703	9456228	9734142	9318178	9456120	9746072
160 psi	9310711	9456180	8986216	9318186	9455981	9734257
200 psi	9310720	9456236		9318194	9442979	
300 psi	9310738	9442871	9798870	9318208	9442987	9734265
400 psi	9310746	9611452		9318216	9455990	
600 psi	9310754	9456244	8985815	9318224	9456007	8985774
800 psi	9310762	9690115		9318232	9128832	
1,000 psi	9310770	9456252	9798404	9318240	9456015	9746048
1,500 psi	9310789	9456260	9734193	9318259	9207511	8985829
2,000 psi	9310797	9455906		9318267	9456023	
3,000 psi	9310800	9455914	8985566	9318275	9435220	8985831
5,000 psi	9310819	9456279		9318283	9442995	
7,500 psi	9325107	9455922		9318291	9128840	
10,000 psi	9790454					
15,000 psi						
Accessory order codes (installed at factory)						
FF, brass pol	+ FF P		+ FF P			
FF, chrome	+ FF C		+ FF C			
FF, SS	+ FF SS		+ FF SS			
UC, SS	-		+ UC S			
RF, black-painted steel			+ RF			
Restrictor			+ R			

Type	213.40		
Size	4"		
Connection	LM	LBM	
Conn. Size	1/4" NPT	1/2" NPT	1/4" NPT
Press. Scale	PSI	PSI	PSI
30" Hg	9314555		9314296
30"-0-15 psi	9314563		9314300
30"-0-30 psi	9314571		9314318
30"-0-60 psi	9314580		9314326
30"-0-100 psi	9314598		9314334
30"-0-160 psi	9314601		9314342
30"-0-200 psi	9314610		9314350
15 psi	9314644	9314121	9314385
30 psi	9314652	9314130	9314393
60 psi	9314660	9314148	9314407
100 psi	9314679	9314156	9314415
160 psi	9314687	9314164	9314423
200 psi	9314695	9314172	9314431
300 psi	9314709	9314180	9314440
400 psi	9314717	9314199	9314458
600 psi	9314725	9314202	9314466
800 psi	9314733	9314210	9314474
1,000 psi	9314741	9314229	9314482
1,500 psi	9314750	9314237	9314490
2,000 psi	9314768	9314245	9314504
3,000 psi	9314776	9314253	9314512
5,000 psi	9314784	9314261	9314520
7,500 psi			
10,000 psi	9314792	9314270	9314539
15,000 psi			
Accessory order codes (installed at factory)			
FF, chrome	+ FF C	+ FF C	
UC, chrome	-	+ UC C	
RF, chrome	+ RF C	+ RF C	
4½" panel kit	+ PM ADAPT		
Restrictor	+ R		

Stock items shown in blue print.

Abbreviations

CBM - Center back mount, FF - Front flange, LM - Lower mount, RF - Rear flange, UC - U-clamp, SS - Stainless steel

Mechanical Pressure > Industrial Gauges > 21X.40PM

Type 21X.40PM

WIKA type 21X.40PM gauges are designed to fit existing paper machine panels. Each gauge is hermetically sealed to prevent moisture from entering during washdown. The hermetic seal makes this gauge liquid fillable for high vibration or pulsation applications. The generously oversized polished stainless steel front flange allows for easy retrofit installation.



Type 212.40PM - Dry case
Type 213.40PM - Liquid filled case

MECHANICAL PRESSURE

Standard Features

Size:	3½"	Dial:	White aluminum
Case:	Forged brass	Pointer:	Black aluminum
Ring:	Polished stainless steel front flange	Accuracy:	± 2/1/2% of span ASME B40.100 Grade A
Wetted Parts:	Copper alloy	Connection:	Back mount
Window:	Acrylic		

Type	212.40PM
Size	3½"
Connection	LBM
Conn. Size	1/4" NPT
Press. Scale	PSI
30" Hg	9838932
30"-0-15 psi	
30"-0-30 psi	
30"-0-60 psi	
30"-0-100 psi	
30"-0-160 psi	
30"-0-200 psi	
15 psi	
30 psi	8998804
60 psi	8998812
100 psi	8998820
160 psi	8998940
200 psi	8998838
300 psi	8998846
400 psi	8998855
600 psi	8998863
800 psi	
1,000 psi	8998871
1,500 psi	
2,000 psi	
3,000 psi	
5,000 psi	
Accessory order codes (installed at factory)	
Glycerine fill	Type 213.40PM
Restrictor	+ R

Available Options

- Cleaned for oxygen service
- Special connections

Applications

- With liquid-filled case for applications with high dynamic pressure pulsations or vibration
- Paper machines and hydraulic presses
- Suitable for gaseous or liquid media that will not obstruct the pressure system

Abbreviations

LBM - Lower back mount
SS - Stainless steel

Stock items shown in **blue** print.

Type 21X.53

WIKA type 21X.53 gauges feature a stainless steel case for protection in harsh environments. The O-ring seal around the connection makes this gauge field liquid fillable. When filled, the 213.53 is excellent for high vibration and pulsation applications.



Type 212.53 - Dry
Type 213.53 - Liquid filled

Standard Features

Size:	2", 2½" & 4"	Pointer:	Black aluminum
Case:	304 SS	Accuracy:	(2" & 2½") ± 2/1/2% of span ASME B40.100 Grade A
Wetted Parts:	Copper alloy		(4") ± 1.0% of span (4" size) ASME B40.100 Grade 1A
Window:	Polycarbonate	Connection:	Lower or back mount
Dial:	White aluminum		
Ring:	Stainless steel polished		

Type	213.53 (Liquid-filled)					
Size	2½"					
Connection	LM			CBM		
Conn. Size	1/4" NPT			1/4" NPT		
Press. Scale	PSI	PSI/BAR	PSI/KG/CM ²	PSI	PSI/BAR	PSI/KG/CM ²
30" Hg	9767002	9691957	9693683	9767185	9692139	9693861
30"-0-15 psi						
30"-0-30 psi	9767010	9691965	9693691			
30"-0-60 psi	9767029	9691974	9693705			
30"-0-100 psi						
30"-0-160 psi						
30"-0-200 psi						
15 psi	9767037	9691982	9693713			9697220
30 psi	9767045	9691990	9693721	9767193	9692147	9693879
60 psi	9767053	9692007	9693739	9767202	9692155	9693887
100 psi	9767061	9692015	9693747	9767215	9692164	9693895
160 psi	9767070	9692024	9693755	9767223	9692172	9693909
200 psi	9767088	9692032	9693764	9767231	9692180	9693917
300 psi	9767096	9692040	9693772	9767240	9692198	9693925
400 psi	9767100	9692058	9693780			
600 psi	9767118	9692066	9693798	9768947	9692202	9693934
800 psi						
1,000 psi	9767126	9692075	9693802	9767258	9692210	9693942
1,500 psi	9767134	9692083	9693810	9768165	9692228	9693950
2,000 psi	9767142	9692091	9693828	9768939	9692236	9693968
3,000 psi	9767150	9692105	9693836	9767266	9692245	9693976
5,000 psi	9767169	9692113	9693845	9767274	9692253	9693985
6,000 psi		9748207		50992598		
10,000 psi	9767177	9692121	9693853	9767282	9692261	9693993
Accessory order codes (installed at factory)						
Front flange, SS		--			+ FF S	
Rear flange, SS		+ RF S			+ RF S	
U-clamp, steel		--			+ UC Z	
U-clamp, SS		--			+ UC S	
Restrictor				+ R		

Stock items shown in blue print.

Available Options

- Drag pointer (max. reading indicator)
- Cleaned for oxygen service
- Special connection

Applications

- Intended for adverse service conditions where pulsating or vibration exists (with liquid filling)
- Hydraulics and compressors
- Suitable for gaseous or liquid media that will not obstruct the pressure system

Abbreviations

LM - Lower mount
CBM - Center back mount
SS - Stainless steel

Type 21X.53

Type	213.53 (Liquid-filled)
Size	2½"
Connection	LM
Conn. Size	7/16"-20 SAE
Press. Scale	PSI/BAR
30" Hg	
30"-0-15 psi	
30"-0-30 psi	
30"-0-60 psi	
30"-0-100 psi	
30"-0-160 psi	
30"-0-200 psi	
15 psi	
30 psi	
60 psi	
100 psi	9795664
160 psi	9795672
200 psi	9795680
300 psi	
400 psi	
600 psi	
800 psi	
1,000 psi	
1,500 psi	
2,000 psi	9795698
3,000 psi	9795702
5,000 psi	9795710
6,000 psi	9795728
10,000 psi	
Accessory order codes (installed)	
Rear flange, SS	+ RF S
Restrictor	+ R

Abbreviations

LM - Lower mount
LBM - Lower back mount
SS - Stainless steel

Type	213.53 (Liquid-filled)					
Size	4"					
Connection	LM		LM		LBM	
Conn. Size	1/4" NPT		1/2" NPT		1/4" NPT	1/2" NPT
Press. Scale	PSI	PSI/KG/CM ²	PSI	PSI/BAR	PSI/KG/CM ²	PSI/BAR
30" Hg	9699028	9694000		9734427	9694239	9734533
30"-0-15 psi	9699036	9694018				
30"-0-30 psi	9699045	9694026				
30"-0-60 psi	9699053	9694035				
30"-0-100 psi	9699061	9694043				
30"-0-160 psi	9699079	9694051				
30"-0-200 psi	9699087	9694069				
15 psi	9699095	9694077		9734320		9734435
30 psi	9699109	9694085		9734338	9694247	9734444
60 psi	9699117	9694094		9734346	9694255	9734452
100 psi	9699125	9694107		9734355	9694264	9734460
160 psi	9699257	9694115		9734363	9694272	9734478
200 psi	9699134	9694124			9694280	
300 psi	9699142	9694132		9734371	9694298	9734486
400 psi	9699150	9694140			9697743	
600 psi	9699168	9694158		9734389	9694302	9734495
800 psi	9699176					
1,000 psi	9699185	9694166	4228732	9734397	9694310	9734508
1,500 psi	9699193	9694175	9766885	9734401	9694328	9734516
2,000 psi	9699206	9694183	9766876	4201591	9694336	
3,000 psi	9699215	9694191	9766893	9734419	9694345	9734525
5,000 psi	9699223	9694205	9766906	4201604	9694353	
6,000 psi						
10,000 psi	9699231	9694213	9766915		9694361	
15,000 psi	9699249	9694221				
Accessory order codes (installed at factory)						
Front flange, SS		--				+ FF S
Rear flange, SS		+ RF S				+ RF S
U-clamp, steel		--				+ UC Z
U-clamp, SS		--				+ UC S
Restrictor				+ R		

Stock items shown in blue print.

Type 21X.53

Type	212.53 (Dry)							
Size	2"		2½"			2½"		
Connection	LM	CBM	LM			CBM		
Conn. Size	1/4" NPT	1/4" NPT	1/4" NPT			1/4" NPT		
Press. Scale	PSI/BAR	PSI/BAR	PSI	PSI/BAR	PSI/KG/CM²	PSI	PSI/BAR	PSI/KG/CM²
30" Hg	4311833	4312074	4269978	4270231	4270496	4270755	4271017	4271271
30"-0-15 psi	4311841		4269986			4270763		
30"-0-30 psi			4269994	4270258	4270517	4270771	4271033	4271298
30"-0-60 psi	4311868		4270002	4270266	4270525	4270780	4271041	4271301
30"-0-100 psi			4270011			4270798		
30"-0-160 psi			4270029			4270801		
30"-0-200 psi			4270037			4270810		
15 psi	4311906	4315014	4270045	4270304	4270569	4270828	4271084	4271343
30 psi	4311914	4315022	4270053	4270312	4270577	4270836	4271092	4271351
60 psi	4311922	4315031	4270061	4270321	4270585	4270844	4271106	4271361
100 psi	4311931	4315049	4270070	4270339	4270593	4270852	4271114	4271379
160 psi	4311949	4315057	4270088	4270347	4270606	4270861	4271122	4271387
200 psi	4311957	4315065	4270096	4270355	4270614	4270879	4271131	4271395
300 psi	4311965	4315073	4270100	4270363	4270622	4270887	4271149	4271408
400 psi	4311973		4270118	4270371	4270631	4270895	4271157	4271416
600 psi	4311981	4315090	4270126	4270381	4270640	4270909	4271165	4271424
800 psi								
1,000 psi	4312007	4315111	4270142		4270666	4270925	4271181	4271441
1,500 psi	4312015	4315120	4270151		4270674	4270933	4271191	4271450
2,000 psi	4312023	4315138	4270169		4270682	4270941	4271203	4271468
3,000 psi	4312031	4315146	4270177		4270691	4270950	4271211	4271476
5,000 psi	4312040	4315154	4270185		4270703	4270968	4271220	4271484
6,000 psi							4271238	
7,500 psi	4312058	4315162					4271246	
10,000 psi	4312066	4315171	4270215	4270470	4270739	4270992	4271254	4271513
15,000 psi								
Accessory order codes (installed at factory)								
Front flange, SS	--	+ FF		--			+ FF	
Rear flange, SS	+ RF	+ RF		+ RF			+ RF	
U-clamp, steel	--	+ UC Z		--			+ UC Z	
U-clamp, SS	--	+ UC S		--			+ UC S	
Restrictor	+ R	+ R		+ R			+ R	

Stock items shown in blue print.

Abbreviations

- LM - Lower mount
- CBM - Center back mount
- SS - Stainless steel

Type 21X.53

Type	212.53 (Dry)		
Size	4"		
Connection	LM	LBM	
Conn. Size	1/4" NPT	1/2" NPT	
Press. Scale	PSI	PSI/KG/CM ²	PSI/BAR
30" Hg	4271531	4271786	4272782
30"-0-15 psi	4271549	4271794	
30"-0-30 psi	4271557	4271808	
30"-0-60 psi	4271565	4271816	
30"-0-100 psi	4271573	4271824	
30"-0-160 psi	4271581	4271832	
30"-0-200 psi	4271590	4271841	
15 psi	4271602	4271859	4272855
30 psi	4271611	4271867	4272863
60 psi	4271620	4271875	4272871
100 psi	4271638	4271883	4272880
160 psi	4271646	4271891	4272898
200 psi	4271654	4271905	
300 psi	4271662	4271913	4272910
400 psi	4271671	4271921	
600 psi	4271689	4271930	4272936
800 psi			
1,000 psi	4271701	4271956	4272952
1,500 psi	4271719	4271964	4272961
2,000 psi	4271727	4271972	4272979
3,000 psi	4271735	4271981	4272987
5,000 psi	4271743	4271999	4272995
10,000 psi	4271760	4272013	
15,000 psi	4271778	4272021	
Accessory order codes (installed at factory)			
Front flange, SS	--		+ FF
Rear flange, SS	+ RF		+ RF
U-clamp, steel	--		+ UC Z
U-clamp, SS	--		+ UC S
Restrictor	+ R		+ R

Stock items shown in blue print.

Abbreviations

- LM - Lower mount
- LBM - Lower back mount
- SS - Stainless steel

Type 23X.53

The rugged construction of WIKA type 23X.53 stainless steel gauges provides resistance to the most corrosive media and environments. These gauges feature 316 SS wetted parts and 304 SS case and crimped ring, and can be liquid-filled in the field.

Standard Features

Size:	2", 2½" & 4"	Accuracy:	(2" & 2½") ± 2/1/2% of span ASME B40.100 Grade A
Case:	304 SS		
Wetted Parts:	316 SS		(4") ± 1.0% of span (4" size) ASME B40.100 Grade 1A
Window:	Polycarbonate	Connection:	Lower or back mount
Dial:	White aluminum		
Ring:	Stainless steel polished		
Pointer:	Black aluminum		



Type 232.53 - Dry case
Type 233.53 - Liquid-filled case

Available Options

- Dampened movement
- Drag pointer (max. reading indicator)
- Cleaned for oxygen service
- Special connection

Applications

- With liquid-filled case for applications with high dynamic pressure pulsations or vibration
- Suitable for corrosive environments and gaseous or liquid media that will not obstruct the pressure system
- Process industry: chemical/petrochemical, power stations, mining, on and off shore, environmental technology, mechanical engineering and plant construction

Abbreviations

LM - Lower mount
CBM - Center back mount
SS - Stainless steel

Stock items shown in blue print.

Type	232.53 (Dry)					
Size	2"		2½"			
Connection	LM	CBM	LM	CBM		
Conn. Size	1/4" NPT		1/4" NPT			
Press. Scale	PSI	PSI	PSI	PSI	PSI/BAR	PSI/KPA
30" Hg	50533614	50533797	9768777	9768394		
30"-0-15 psi	50533622	50533801				
30"-0-30 psi	50533631	50533819	9768769	9768386		
30"-0-60 psi	50533649	50533827	9768750	9768378		
30"-0-100 psi	50533657	50533835				
30"-0-160 psi	50533665	50533843	9768742	9768360		
30"-0-200 psi	50533673	50533851				
15 psi	50533690	50533860	9768734	9768351		
30 psi	4222680	50533878	9768726	9768343		
60 psi	4282907	4214318	9768718	9768335	8992848	8993089
100 psi	4222698	4282915	9768700	9768327	8992856	8993097
160 psi	50466721	50466747	9768696	9768319	8992865	8993101
200 psi	4282923	50533886	9768688	9768300	8992873	8993119
300 psi	50533711	50533894	9768670	9768297	8992881	8993127
400 psi	50533720	50533908	9768661	9768289		
600 psi	4222702	50533916	9768653	9768270	9779685	9779693
800 psi	50533738	50533924				
1,000 psi	4222710	50533932	9768645	9768262	8992899	8993135
1,500 psi	50533746	50533941	9768637	9768254	8992903	8993144
2,000 psi	50533754	50533959	9768629	9768246	8992911	8993152
3,000 psi	50466739	50466755	9768610	9768238	8992929	8993160
5,000 psi	50533762	50533967	9768602	9768220	8992937	8993178
6,000 psi					8993208	8992945
10,000 psi	50533771	50533975	9768599	9768211	8992954	8993195
15,000 psi	50533789	50533983		9779715	9776715	9779723
Accessory order codes (installed at factory)						
Front flange, SS	--	+ FF S	--			+ FF S
U-clamp, steel	--	+ UC Z	--			+ UC Z
U-clamp, SS	--	+ UC S	--			+ UC S
Rear flange, SS	+ RF S					
Restrictor	+ R					
Glycerine fill	Type 233.53					

Type 23X.53

Type	232.53 (Dry)		
Size	4"		
Connection	LM	LM	LBM
Conn. Size	1/4" NPT	1/2" NPT	1/2" NPT
Press. Scale	PSI	PSI	PSI
30" Hg	9767576	9768459	9737057
30"-0-15 psi	9737910	9768467	9737065
30"-0-30 psi	9767398	9768475	9737073
30"-0-60 psi	9767401	9768483	9737081
30"-0-100 psi	9737898	9737880	9737090
30"-0-160 psi	9767410	9768491	9737103
30"-0-200 psi	9737901	9768505	9737111
15 psi	9767428	9768513	9737120
30 psi	9767436	9768521	9737138
60 psi	9767444	9768530	9737146
100 psi	9767452	9768548	9737154
160 psi	9767460	9768556	9737162
200 psi	9767479	9768564	9737170
300 psi	9767487	9768572	9737189
400 psi	9767495	9768580	9737197
600 psi	9767509	9768963	9737200
800 psi			9737219
1,000 psi	9767517	9768858	9737227
1,500 psi		9768866	9737235
2,000 psi		9768807	9737243
3,000 psi		9768874	9737251
5,000 psi		9768823	9737260
10,000 psi		9768831	9737278
15,000 psi		9768840	9737286
Accessory order codes (installed at factory)			
Front flange, SS	--		+ FF S
U-clamp, steel	--		+ UC Z
U-clamp, SS	--		+ UC S
4½" panel kit	--		+ PM ADAPT
Rear flange, SS		+ RF S	
Restrictor		+ R	
Glycerine fill		Type 233.53	

Type	233.53 (Glycerine-filled)				
Size	2½"		4"		
Connection	LM	CBM	LM	LM	LBM
Conn. Size	1/4" NPT		1/4" NPT	1/2" NPT	
Press. Scale	PSI	PSI	PSI	PSI	PSI
30" Hg	9833646	9833310	9833124	9833328	9831504
30"-0-15 psi			9831775	9833336	9831512
30"-0-30 psi	9833638	9833302	9832993	9833345	9831520
30"-0-60 psi	9833620	9833298	9833000	9833353	9831538
30"-0-100 psi			9831759	9831741	9831546
30"-0-160 psi	9833612	9833280	9833018	9833361	9831555
30"-0-200 psi			9831767	9833379	9831563
15 psi	9833604	9833272	9833026	9833387	9831571
30 psi	9833590	9833264	9833035	9833395	9831589
60 psi	9833582	9833255	9833043	9833409	9831597
100 psi	9833574	9833247	9833051	9833417	9831601
160 psi	9833565	9833239	9833069	9833425	9831619
200 psi	9833557	9833221	9833077	9833434	9831627
300 psi	9833549	9833213	9833085	9833442	9831635
400 psi	9833531	9833205	9833094	9833450	9831644
600 psi	9833523	9833191	9833107	9833727	9831652
1,000 psi	9833515	9833183	9833115	9833697	9831678
1,500 psi	9833506	9833175		9833701	9831686
2,000 psi	9833493	9833166		9833655	9831695
3,000 psi	9833485	9833158		9833719	9831708
5,000 psi	9833476	9833140		9833663	9831716
10,000 psi	9833468	9833132		9833671	9831725
15,000 psi				9833689	9831733
Accessory order codes (installed at factory)					
See tables for type 232.53					

Abbreviations

- LM - Lower mount
- CBM - Center back mount
- LBM - Lower back mount
- SS - Stainless steel

Stock items shown in blue print.

Type 21X.54

Available in ranges up to 10,000 psi, WIKA type 21X.54 pressure gauges offer heavy-duty service in industrial applications and environments. They feature a stainless steel case and the industrial grade Swiss movement assures repeatable accuracy and long service life.



Type 212.54 - Dry case
Type 213.54 - Liquid filled case

Standard Features

Size:	4"	Ring:	Stainless steel polished
Case:	304 SS	Pointer:	Black aluminum - adjustable
Wetted Parts:	Copper alloy	Accuracy:	±1.0% of span (4" size)
Window:	Safety glass		ASME B40.100 Grade1A
Dial:	White aluminum	Connection:	Lower or back mount

Type	212.54 (Dry)		
Size	4"		
Connection	LM	LM	LBM
Conn. Size	1/4" NPT	1/2" NPT	
Press. Scale	PSI	PSI	PSI
30" Hg			
30"-0-15 psi			
30"-0-30 psi			
30"-0-60 psi			
30"-0-100 psi			
30"-0-160 psi			
30"-0-200 psi			
10 psi	4212011		
15 psi	4212029		
30 psi	4212037		
60 psi	4212045		
100 psi	4212053		
160 psi	4212061		
200 psi	4212070		
300 psi	4212088		
400 psi	4212096		
600 psi	4212100		
800 psi			
1,000 psi	4212126	4212363	
1,500 psi	4212134	4212371	
2,000 psi	4212142	4212380	
3,000 psi	4212151	4212398	
5,000 psi	4212169	4212401	
10,000 psi	4212177	4212410	
Accessory order codes (installed at factory)			
Front flange, SS	--		+ FF S
Rear flange, SS		+ RF S	
Restrictor		+ R	
Glycerine fill		Type 213.54	

Available Options

- Instrument glass or acrylic window
- Drag pointer (maximum reading indicator)
- Cleaned for oxygen service
- Special connections

Applications

- Vibration and shock resistant (with liquid filling)
- Stainless steel case with removable bayonet ring
- Pressure ranges up to 15,000 psi

Abbreviations

LM - Lower mount
CBM - Center back mount
SS - Stainless steel

Stock items shown in blue print.

Type 23X.54

Type 23X.54 gauges feature 316 SS wetted parts and 304 SS case and bayonet ring, a laminated safety glass window and can be liquid-filled in the field. These gauges are ideal for process, chemical applications, oil exploration and production, power generation and pollution control equipment.



Type 232.54 - Dry case
Type 233.54 - Liquid-filled case

Standard Features

Size:	2½" & 4"	Pointer:	Black aluminum, adjustable
Case:	304 SS	Accuracy:	(2½") ± 2/1/2% of span
Ring:	Polished stainless steel		ASME B40.100 Grade A
Wetted Parts:	316 SS		(4") ± 1.0% of span (4" size)
Window:	Safety glass		ASME B40.100 Grade 1A
Dial:	White aluminum	Connection:	Lower and back mount

Type	232.54 (Dry)					
Size	2½"					
Connection	LM			CBM		
Conn. Size	1/4" NPT					
Press. Scale	PSI	PSI/BAR	PSI/KG/CM²	PSI	PSI/BAR	PSI/KG/CM²
30" Hg	9744827	9735245	9694531	9745068	9735385	9694778
30"-0-15 psi	9744835		9694549	9745076		
30"-0-30 psi	9744843		9694557	9745084		
30"-0-60 psi	9744851		9694565	9745092		
30"-0-100 psi	9744860		9694574	9745106		
30"-0-160 psi	9744878		9694582	9745114		
30"-0-200 psi	9744886		9694590	9745122		
15 psi	9744894	9735114	9694604	9745130	9735254	9694786
30 psi	9744908	9735122	9694612	9745149	9735262	9694795
60 psi	9744916	9735130	9694620	9745157	9735270	9694808
100 psi	9744924	9735148	9694638	9745165	9735288	9694816
160 psi	9744932	9735156	9694646	9745173	9735296	9694825
200 psi	9744940		9694655	9745181		9694833
300 psi	9744959	9735165	9694663	9745190	9735300	9694841
400 psi	9744967		9694671	9745203		9694859
600 psi	9744975	9735173	9694689	9745211	9735318	9694867
800 psi	9744983		9694697	9745220		
1,000 psi	9744991	9735181	9694701	9745238	9735326	9694875
1,500 psi	9745009	9735199	9694719	9745246	9735335	9694884
2,000 psi	9745017		9694727	9745254		9694892
3,000 psi	9745025	9735203	9694735	9745262	9735343	9694905
5,000 psi	9745033	9735211	9694744	9745270	9735351	9694914
10,000 psi	9745041	9735229	9694752	9745289	9735369	9694922
15,000 psi	9745050	9735237		9694760	9745297	9735377
Accessory order codes (installed at factory)						
Front flange, SS		--				+ FF S
U-Clamp, steel		--				+ UC Z
U-Clamp, SS		--				+ UC S
Rear flange, SS				+ RF S		
Restrictor				+ R		
Glycerine fill						Type 233.54

Available Options

- Dampened movement
- Instrument glass or acrylic window
- Drag pointer (max. reading indicator)
- Cleaned for oxygen service
- Special connections

Abbreviations

LM - Lower mount
CBM - Center back mount
SS - Stainless steel

Stock items shown in blue print.

Type 23X.54

Type	232.54 (Dry)					
Size	4"					
Connection	LM	LM			LBM	
Conn. Size	1/4" NPT	1/2" NPT			1/2" NPT	
Press. Scale	PSI	PSI	PSI/BAR	PSI/KG/CM ²	PSI	PSI/BAR
30" Hg	9745300	9745548	9734826	9694930	9745785	9734966
30"-0-15 psi	9745319	9745556		9694948	9745793	
30"-0-30 psi	9745327	9745564		9694956	9745807	
30"-0-60 psi	9745335	9745572		9694965	9745815	
30"-0-100 psi	9745343	9745580		9694973	9745823	
30"-0-160 psi	9745351	9745599			9745831	
30"-0-200 psi	9745360	9745602			9745840	
15 psi	9745378	9745610	9734699	9694981	9745858	9734835
30 psi	9745386	9745629	9734703	9694999	9745866	9734843
60 psi	9745394	9745637	9734711	9695006	9745874	9734851
100 psi	9745408	9745645	9734729	9695015	9745882	9734869
160 psi	9745416	9745653	9734737	9695023	9745890	9734877
200 psi	9745424	9745661		9695031	9745904	
300 psi	9745432	9745670	9734745	9695049	9745912	9734885
400 psi	9745440	9745688		9695057	9745920	
600 psi	9745459	9745696	9734754	9695065	9745939	9734894
800 psi	9745467	9745700		9695074	9745947	
1,000 psi	9745475	9745718	9734762	9695082	9745955	9734907
1,500 psi	9745483	9745726	9734770	9695090	9745963	9734915
2,000 psi	9745491	9745734		9695104	9745971	
3,000 psi	9745505	9745742	9734788	9695112	9745980	9734924
5,000 psi	9745513	9745750	9734796	9695120	9745998	9734932
10,000 psi	9745521	9745769	9734800	9695138	9746005	9734940
15,000 psi	9745530	9745777	9734818	9695146	9746013	9734958
Accessory order codes (installed at factory)						
Front flange, SS		--			+ FF S	
4½" panel kit		--			+ PM ADAPT	
U-clamp, steel		--			+ UC Z	
U-clamp, SS		--			+ UC S	
Rear flange, SS			+ RF S			
Restrictor			+ R			
Glycerine fill			Type 233.54			

Stock items shown in blue print.

Abbreviations

- LM - Lower mount
- LBM - Lower back mount
- SS - Stainless steel

Type 23X.54

Type	233.54 (Glycerine-filled)				
	2½"		4"		
Size	LM	CBM	LM	LM	LBM
Conn. Size	1/4" NPT		1/4" NPT	1/2" NPT	
Press. Scale	PSI	PSI	PSI	PSI	PSI
30" Hg	9831784	9832020	9832275	9832518	9832755
30"-0-15 psi	9831792	9832046	9832284	9832526	9832764
30"-0-30 psi	9831805	9832055	9832292	9832535	9832772
30"-0-60 psi	9831814	9832063	9832305	9832543	9832780
30"-0-100 psi	9831822	9832071	9832314	9832551	9832798
30"-0-160 psi	9831830	9832089	9832322	9832569	9832802
30"-0-200 psi	9831848	9832097	9832330	9832577	9832810
15 psi	9831856	9832101	9832348	9832585	9832828
30 psi	9831865	9832119	9832356	9832594	9832836
60 psi	9831873	9832127	9832365	9832607	9832845
100 psi	9831881	9832135	9832373	9832615	9832853
160 psi	9831899	9832144	9832381	9832624	9832861
200 psi	9831903	9832152	9832399	9832632	9832879
300 psi	9831911	9832160	9832403	9832640	9832887
400 psi	9831929	9832178	9832411	9832658	9832895
600 psi	9831937	9832186	9832429	9832666	9832909
800 psi	9831945	9832195	9832437	9832675	9832917
1,000 psi	9831954	9832208	9832445	9832683	9832925
1,500 psi	9831962	9832216	9832454	9832691	9832934
2,000 psi	9831970	9832225	9832462	9832705	9832942
3,000 psi	9831988	9832233	9832470	9832713	9832950
5,000 psi	9831996	9832241	9832488	9832721	9832968
10,000 psi	9832004	9832259	9832496	9832739	9832976
15,000 psi	9832012	9832267	9832500	9832747	9832985

Accessory order codes (installed at factory)
See tables for type 232.54

Stock items shown in **blue print**.

Abbreviations

- LM - Lower mount
- LBM - Lower back mount
- CBM- Center back mount
- SS - Stainless steel

Type	232.54 XMAS Tree Gauge
Size	4"
Connection	LM
Conn. Size	1/2" NPT
Press. Scale	PSI
1,000 psi	8992350
1,500 psi	8992342
2,000 psi	8992334
3,000 psi	8992325
5,000 psi	8992317
10,000 psi	8992309

Type	232.54 Receiver
Size	2½"
Connection	LM
Conn. Size	1/4" NPT
100%	9749470
10 sq. ft.	9749462

Type 233.55

The type 233.55 LBM is specifically designed and manufactured to exact panel builder requirements. With exclusive features, it is ideal when used for panel mount gauges in the oil and gas, refinery, petrochemical, and food and beverage industries.



Standard Features

Size:	2½"	Pointer:	Black aluminum
Case:	304 SS	Accuracy:	±2/12% of span
Wetted Parts:	316 SS		ASME B40.100 Grade A
Window:	Safety glass	Connection:	Lower back mount
Dial:	White aluminum	Liquid fill:	Glycerine
Ring:	Stainless steel polished	Restrictor:	Standard

Type	233.55			
Size	2½"			
Connection	LBM			
Conn. Size	1/4" NPT			
Press. Scale	PSI	PSI/BAR	PSI/KPA	PSI/KG/CM ²
30" Hg	4282811	4283078	4283337	4283591
30"-0-15 psi	4282829	4283086	4283345	4283604
30"-0-30 psi	4282837	4283094	4283354	4283613
30"-0-60 psi	4282845	4283107	4283362	4283621
30"-0-100 psi	4282854	4283115	4283370	4283639
30"-0-160 psi	4282862	4283124	4283388	4283647
30"-0-200 psi	4282870	4283133	4283396	4283655
15 psi	4282888	4283141	4283400	4283664
30 psi	4282896	4283159	4283418	4283672
60 psi	4282900	4283167	4283426	4283680
100 psi	4282918	4283175	4283434	4283698
160 psi	4282926	4283184	4283443	4283702
200 psi	4282934	4283192	4283451	4283710
300 psi	4282943	4283204	4283469	4283728
400 psi	4282951	4283214	4283477	4283736
600 psi	4282969	4283222	4283485	4283744
800 psi	4282977	4283230	4283494	4283753
1,000 psi	4282985	4283248	4283507	4283761
1,500 psi	4282994	4283256	4283515	4283779
2,000 psi	4283000	4283264	4283524	4283787
3,000 psi	4283018	4283273	4283532	4283795
5,000 psi	4283026	4283281	4283540	4283809
6,000 psi	4283034	4283299	4283558	4283817
10,000 psi	4283044	4283303	4283566	4283825
15,000 psi	4283052	4283311	4283574	4283834
20,000 psi	4283060	4283329	4283583	4283842

Available Options

- Special connections

Applications

- With liquid-filled case for applications with high dynamic pressure pulsations or vibration
- Suitable for corrosive environments and gaseous or liquid media that will not obstruct the pressure system
- Process industry: chemical/petrochemical, power stations, mining, on and off shore, environmental technology, mechanical engineering and plant construction

Abbreviations

LM - Lower mount
 LBM - Lower back mount
 SS - Stainless steel

Stock items shown in blue print.

Type 23X.30

WIKA type 23X.30 stainless steel gauges have a solid-front/blow-out back safety case. This gauge is an ideal choice for process, chemical, petrochemical, oil exploration and production, power generation applications and any other application which demands reliable pressure measurement instrumentation.



Type 232.30 - Dry case
Type 233.30 - Liquid-filled case (LM only)

Standard Features

Size:	2½" & 4"	Pointer:	Black aluminum, adjustable
Case:	304 SS	Accuracy:	(2½") ± 2/1/2% of span
Ring:	Polished stainless steel		ASME B40.100 Grade A
Wetted Parts:	316 SS		(4") ± 1.0% of span (4" size)
Window:	(2½") Polycarbonate		ASME B40.100 Grade 1A
	(4") Safety glass	Connection:	Lower and back mount
Dial:	White aluminum		

Type	232.30 (Dry)				233.30 (Filled)	
	2½"		4"		2½"	4"
Connection	LM	LBM	LM	LBM	LM	LM
Conn. Size	1/4" NPT		1/2" NPT		1/4" NPT	1/2" NPT
Press. Scale	PSI	PSI	PSI	PSI	PSI	PSI
30" Hg	9305645	9367071	9366750	8596271	9305637	
30"-0-15 psi	9365044	9365079			9366580	
30"-0-30 psi	9314822	9481486	9366776	9562559	9364994	
30"-0-60 psi	9305378	9197141			9366598	
30"-0-100 psi	9542353	9319646			9367853	
30"-0-160 psi	9365052	9469168			9319638	
30"-0-200 psi	9367250				9637141	
15 psi	9305653	9244808	9366830	9253289	9305394	9361081
30 psi	9240160	9244816	9366849	9253270	9251618	9361090
60 psi	9240179	9244832	9366857	8596298	9251626	9361103
100 psi	9240187	9244840	9366865	9253084	9251634	9361111
160 psi	9240195	9244859	9366873	8596301	9251642	9361120
200 psi	9240209	9244867	9366881	9253076	9251650	9361138
300 psi	9240217	9244875	9366890	9821082	9251669	9361146
400 psi	9240225	9244883	9366903	8542805	9251677	9361154
600 psi	9240233	9244905	9366911	9253050	9251685	9361162
800 psi					9251693	9361170
1,000 psi	9240411	9244913	9366938	8513554	9251707	9361189
1,500 psi	9240420	9244921	9366946	8541574	9251715	9361197
2,000 psi	9240438	9244930	9366954		9251723	9361200
3,000 psi	9240446	9244948	9366962		9251731	9361219
5,000 psi	9240454	9244956	9366970		9251740	9361227
10,000 psi	9305661	9244964	9366989		9305629	9361235
15,000 psi	9482644	9153810	9366997		9542345	9361243
20,000 psi	N/A	N/A	8596336		N/A	9829601
Accessory order codes (installed at factory)						
Front flange, SS	+ FF S		+ FF S		+ FF S	+ FF S
4½" panel kit	--		+ PM		--	+ PM
Restrictor	+ R		+ R		+ R	+ R

Stock items shown in blue print.

Available Options

- Dampened movement
- Drag pointer (max. reading indicator)
- Cleaned for oxygen service
- Magnetic or inductive contact switches
- Special connections

Applications

- With liquid-filled case for applications with high dynamic pressure pulsations or vibration
- Suitable for corrosive environments and gaseous or liquid media that will not obstruct the pressure system
- Process industry: chemical/petrochemical, power stations, mining, on and off shore, environmental technology, mechanical engineering and plant construction

Abbreviations

LM - Lower mount
LBM - Lower back mount
SS - Stainless steel

Mechanical Pressure > Industrial Gauges > 23X.50

Type 23X.50

Applications

- With liquid-filled case for applications with high dynamic pressure pulsations or vibration
- Suitable for corrosive environments and gaseous or liquid media that will not obstruct the pressure system
- Process industry: chemical/petrochemical, power stations, mining, on and offshore, environmental technology, mechanical engineering and plant construction

Standard Features

Size:	2½", 4", 4½" & 6"	Pointer:	Black aluminum, adjustable
Case:	304 SS	Accuracy:	(2½") ±2/12% of span ASME B40.100 Grade A
Wetted Parts:	316 SS		(4" & up) ±1% of span ASME B40.100 Grade 1A
Window:	(2½") Polycarbonate (4" & larger) Safety glass	Connection:	Lower or back mount
Dial:	White aluminum		
Ring:	Stainless steel polished		



Type 232.50 - Dry case
Type 233.50 - Liquid-filled case

Available Options

- Dampened movement
- Safety glass window
- Drag pointer (max. reading indicator)
- Cleaned for oxygen service
- Magnetic or inductive contact switches
- Special connections

Type	232.50 (Dry)					
Size	2½"		4"		4½"	
Connection	LM	CBM	LM	LBM	LM	LBM
Conn. Size	1/4" NPT		1/2" NPT		1/2" NPT	
Press. Scale	PSI	PSI	PSI	PSI	PSI	PSI
30" Hg	9110992				50474511	50474588
30"-0-15 psi					50474529	50474596
30"-0-30 psi					50474537	50474600
30"-0-60 psi					50474545	50474618
30"-0-100 psi					50474553	50474626
30"-0-160 psi					50474561	50474634
30"-0-200 psi					50474570	50474642
10 psi						
15 psi	9111000	9110062	9319492		50474171	50474359
30 psi	9111018	9110070	9226860		50474197	50474367
60 psi	9111026	9110089	9154671		50474201	50474375
100 psi	9111034	9110097	9189459	50999452	50474219	50474383
160 psi	9111042	9110100	9189467		50474235	50474391
200 psi	9111050	9110119	9154701		50474243	50474405
300 psi	9111069	9110127	9154710		50474251	50474413
400 psi	9111077	9110143	9154728		50474260	50474421
600 psi	9111085	9110151			50474278	50474430
800 psi					50474286	50474448
1,000 psi	9111107	9110178	9154752	50997591	50474294	50474456
1,500 psi	9111115	9110186			50474308	50474464
2,000 psi	9111123	9110194	9212744		50474316	50474472
3,000 psi	9111131	9110208	9232087		50474324	50474481
5,000 psi	9111140	9110216	9145664		50474332	50474499
10,000 psi	9111158	9110224	9319506		50474341	50474502
15,000 psi					50474651	50474677
20,000 psi					50474669	50474685
Accessory order codes (installed at factory)						
Front flange, SS	--	+ FF S	--	+ FF S	--	+ FF S
Rear flange, SS				+ RF S		
Restrictor				+ R		
Glycerine fill				Type 233.50		

Stock items shown in blue print.

Type	232.50 (Dry)		
Size	6"		
Connection	LM	LM	LBM
Conn. Size	1/2" NPT		
Press. Scale	PSI	PSI/BAR	PSI
30" Hg	4213688	4213939	4214218
30"-0-15 psi	4213696		4214226
30"-0-30 psi	4213700		4214234
30"-0-60 psi	4213718		4214242
30"-0-100 psi	4213726		4214251
30"-0-160 psi	4213734		4214269
30"-0-200 psi	4213742		4214277
10 psi			
15 psi	4213751	4213947	4214285
30 psi	4213769	4213955	4214293
60 psi	4213777	4213963	4214307
100 psi	4213785	4213971	4214315
160 psi	4213793	4213981	4214323
200 psi	4213807		4214331
300 psi	4213815	4213999	4214340
400 psi	4213823		4214358
600 psi	4213831	4214005	4214366
800 psi	4213840		4214374
1,000 psi	4213858	4214013	4214382
1,500 psi	4213866	4214021	4214391
2,000 psi	4213874		4214404
3,000 psi	4213882	4214030	4214412
5,000 psi	4213891	4214048	4214421
10,000 psi	4213904	4214056	4214439
15,000 psi	4213912	4214064	4214447
20,000 psi	4213921		4214587
Accessory order codes (installed at factory)			
Front flange, SS	--	--	+ FF S
Rear flange, SS		+ RF S	
Restrictor		+ R	
Glycerine fill		Type 233.50	

Abbreviations LM - Lower mount,
LBM - Lower back mount, SS - Stainless steel

Type 21X.34

Specifically designed for the chemical and petroleum processing industries, WIKA XSEL™ process gauges have the construction, materials and engineering it takes to withstand rugged conditions. They are engineered to deliver years of accurate service, while withstanding vibration, corrosive media, corrosive environments and a wide range of temperature extremes. With the proven durability and performance of the XSEL™ process gauge series, it comes with an industry best warranty.



Type 212.34 - Dry case
Type 213.34 - Liquid-filled case

MECHANICAL PRESSURE

Standard Features

Size:	4½"	Pointer:	Black aluminum, adjustable
Case:	Black Pocan®	Accuracy:	±0.5% of span
Ring:	Threaded black Pocan®		ASME B40.100 Grade 2A
Wetted Parts:	Copper alloy	Connection:	Lower mount
Window:	Acrylic	Restrictor:	Standard
Dial:	White aluminum		

Type	212.34		213.34
Size	4½"		
Connection	LM		
Conn. Size	1/4" NPT	1/2" NPT	1/4" NPT
Press. Scale	PSI	PSI	PSI
30" Hg	9834036	9834257	9834740
30"-0-15 psi	9834044	9834265	9834758
30"-0-30 psi	9834052	9834273	9834766
30"-0-60 psi	9834060	9834281	9834775
30"-0-100 psi	9834079	9834290	9834783
30"-0-160 psi	9834087	9834303	9834791
30"-0-200 psi	9834095		9834805
15 psi	9834117	9834338	9834813
30 psi	9834125	9834346	9834821
60 psi	9834133	9834354	9834839
100 psi	9834141	9834362	9834847
160 psi	9834150	9834370	9834855
200 psi	9834168	9834389	9834864
300 psi	9834176	9834397	9834872
400 psi	9834184	9834400	9834880
600 psi	9834192	9834419	9834898
800 psi	9834982	9834990	9834902
1,000 psi	9834206	9834427	9834910
Accessory order codes (installed at factory)			
4½ panel kit	+ PM		
External zero adjust	+ EXT ADJ		
Dampened movement	+ DAMP	--	
Glycerine fill	Type 213.34		
Silicone fill	Type 213.34 + SIL		

Available Options

- Dampened movement
- Safety glass or instrument glass window
- Drag pointer (maximum reading indicator)
- Cleaned for oxygen service
- Magnetic or inductive contact switches
- Special connections

Applications

- A liquid-filled case and socket restrictor are available for applications with high dynamic pressure pulsations or vibration
- Suitable for corrosive environments and gaseous or liquid media that will not obstruct the pressure system
- Process industry: chemical/petrochemical, power stations, mining, on and offshore, environmental technology, mechanical engineering and plant construction

Abbreviations

LM - Lower mount
SS - Stainless steel

Stock items shown in blue print.

Type 22X.34

Specifically designed for the chemical and petroleum processing industries, WIKA XSEL™ process gauges have the construction, materials and engineering it takes to withstand rugged conditions. They are engineered to deliver years of accurate service, while withstanding vibration, corrosive media, corrosive environments and a wide range of temperature extremes. WIKA is so confident in the durability and performance of the XSEL™ process gauge series, that it comes with an industry leading warranty.

Standard Features

Size:	4½"	Pointer:	Black aluminum, adjustable
Case:	Black Pocan®	Accuracy:	±0.5% of span
Ring:	Threaded black Pocan®		ASME B40.100 Grade 2A
Wetted Parts:	1019 steel / 316L SS	Connection:	Lower mount
Window:	Acrylic	Restrictor:	Standard
Dial:	White aluminum		

XSEL™



Type 222.34 - Dry case
Type 223.34 - Liquid-filled case

Type	222.34
Size	4½"
Connection	LM
Conn. Size	1/2" NPT
Press. Scale	PSI
30" Hg	4332670
30"-0-15 psi	4353639
30"-0-30 psi	4353647
30"-0-60 psi	4353656
30"-0-100 psi	4353664
30"-0-160 psi	4353672
30"-0-200 psi	4353680
15 psi	4353532
30 psi	4332688
60 psi	4332696
100 psi	4332709
160 psi	4332717
200 psi	4332725
300 psi	4353698
400 psi	4332733
600 psi	4332741
800 psi	4353702
1,000 psi	4332751
1,500 psi	4353728
2,000 psi	4353736
3,000 psi	4353745
5,000 psi	4353753
Accessory order codes (installed)	
4½ panel kit	+ PM
External zero adjust	+ EXT ADJ
Dampened movement	+ DAMP
Silicone fill	Type 213.34 + SIL

Available Options

- Dampened movement
- Safety glass or instrument glass window
- Drag pointer (maximum reading indicator)
- Cleaned for oxygen service
- Magnetic or inductive contact switches
- Special connections

Applications

- A liquid-filled case and socket restrictor are available for applications with high dynamic pressure pulsations or vibration
- Suitable for corrosive environments and gaseous or liquid media that will not obstruct the pressure system
- Process industry: chemical/petrochemical, power stations, mining, on and off shore, environmental technology, mechanical engineering and plant construction

Abbreviations

LM - Lower mount
SS - Stainless steel

Stock items shown in blue print.

Mechanical Pressure > Process Gauges > 23X.34

Type 23X.34



Specifically designed for the chemical and petroleum processing industries, WIKA XSEL™ process gauges have the construction, materials and engineering it takes to withstand rugged conditions. They are engineered to deliver years of accurate service, while withstanding vibration, corrosive media, corrosive environments and a wide range of temperature extremes. WIKA is so confident in the durability and performance of the XSEL™ process gauge series, that it comes with an industry leading warranty.

Standard Features

Size:	4½" & 6"	Pointer:	Black aluminum, adjustable
Case:	Black Pocan®	Accuracy:	±0.5% of span
Ring:	Threaded black Pocan®	Connection:	ASME B40.100 Grade 2A
Wetted Parts:	316L SS	Connection:	Lower mount and lower back mount
Window:	Acrylic	Restrictor:	Standard
Dial:	White aluminum		



Type 232.34 - Dry case
Type 233.34 - Liquid-filled case

MECHANICAL PRESSURE

Type	232.34 (Dry)			233.34 (Filled)			
Size	4½"			4½"			
Connection	LM	LM	LBM	LM	LM		
Conn. Size	1/4" NPT	1/2" NPT	1/2" NPT	1/4" NPT	1/2" NPT		
Press. Scale	PSI	PSI	PSI/KPA	PSI	PSI	PSI/KPA	
30" Hg	9834478	9834729	9837604	4217004	9833735	9833914	9836769
30"-0-15 psi	9834486	9834737	9837566		9833744	9833922	9836777
30"-0-30 psi	9834494	9834745	9837523	4220854	9833752	9833930	9836785
30"-0-60 psi	9834508	9834753	9837485		9833760	9833948	9836794
30"-0-100 psi	9834516	9834761	9792818		9833778	9833956	9836807
30"-0-160 psi	9834524	9834770			9833786	9833965	
30"-0-200 psi	9834532	9834788	9837361		9833795	9833973	
30"-0-300 psi	4260163	4260180					
30"-0-400 psi	4260171	4260198					
15 psi	9834559	9834800	9776885	4242131	9833808	9833981	9836824
30 psi	9834567	9834818	9837680	4247923	9833816	9833999	9836832
60 psi	9834575	9834826	9776877	9797607	9833825	9834006	9836840
100 psi	9834583	9834834	9837760	9797615	9833833	9834015	9836858
160 psi	9834591	9834842	9776869	9797624	9833841	9834023	9836866
200 psi	9834605	9834850	9837841	9797632	9833859	9834031	9836875
300 psi	9834613	9834869	9837884	9797640	9833867	9834049	9836883
400 psi	9834621	9834877	8985116	9797658	9833875	9834057	9836891
600 psi	9834630	9834885	9837965	9797666	9833884	9834065	9836905
800 psi	9835008	9834974		9797675	9833905	9834155	
1,000 psi	9834648	9834893	9778918	9797683	9833892	9834074	9836913
1,500 psi	9793318	9834907	9838082	4247931		9834082	9836921
2,000 psi	9793661	9834915	9838120	4247940		9834090	9836939
3,000 psi	9748911	9834923	9838163	4247958		9834104	9836947
5,000 psi	9793521	9834931	9838201	4247966		9834112	9836955
10,000 psi	9793679	9834940	9838244			9834120	\$184.25
15,000 psi		9834958				9834138	
20,000 psi	N/A	9834966			N/A	9834146	
Accessory order codes (installed at factory)							
4½ panel kit					+ PM		
External zero adjust					+ EXT ADJ		
Dampened movement		+ DAMP				--	
Glycerine fill		Type 233.34				--	
Silicone fill		Type 233.34 + SIL				-	

Available Options

- Dampened movement
- Safety glass or instrument glass window
- Drag pointer (maximum reading indicator)
- Cleaned for oxygen service
- Magnetic or inductive contact switches
- Special connections

Applications

- A liquid-filled case and socket restrictor are available for applications with high dynamic pressure pulsations or vibration
- Suitable for corrosive environments and gaseous or liquid media that will not obstruct the pressure system
- Process industry: chemical/petrochemical, power stations, mining, on and offshore, environmental technology, mechanical engineering and plant construction

Abbreviations

LM - Lower mount
SS - Stainless steel

Stock items shown in blue print

Type 23X.34

MECHANICAL PRESSURE

Type	232.34 (Damp)	232.34 (Dry)
Size	4½"	6"
Connection	LM	LM
Conn. Size	1/2" NPT	1/2" NPT
Press. Scale	PSI	PSI
30" Hg	4334478	4317492
30"-0-15 psi		
30"-0-30 psi		
30"-0-60 psi		
30"-0-100 psi		
30"-0-160 psi		
30"-0-200 psi		
30"-0-300 psi		
30"-0-400 psi		
15 psi	4339623	
30 psi	4334486	4317505
60 psi	4334494	4317513
100 psi	4333960	4317590
160 psi	4333978	4317521
200 psi	4334507	4317531
300 psi	4337329	4317549
400 psi	4333986	
600 psi	4334515	4317557
800 psi	4334523	
1,000 psi	4334531	4317565
1,500 psi	4334541	4343281
2,000 psi	4333994	
3,000 psi	4334559	
5,000 psi	4334567	
10,000 psi		
15,000 psi		
20,000 psi		
Accessory order codes (installed at factory)		
4½ panel kit	+ PM	--
External zero adjust	+ EXT ADJ	--
Glycerine fill	Type 233.34	
Silicone fill	Type 233.34 + SIL	

Liquid Fill Conversion Kits (Use for preparing a dry gauge for liquid filling)		
For use with	Conn.	P/N
Glycerine/Silicone Material: EPDM	LM	1126768
	LBM	2044480
Halocarbon® Material: Viton®	LM	1654268
	LBM	2044498

Abbreviations
 LM - Lower mount
 LBM - Lower back mount
 SS - Stainless steel

Stock items shown in blue print

Type 26X.34



Specifically designed for the chemical and petroleum processing industries, WIKA XSEL™ process gauges have the construction, materials and engineering it takes to withstand rugged conditions. They are engineered to deliver years of accurate service, while withstanding vibration, corrosive media, corrosive environments and a wide range of temperature extremes. WIKA is so confident in the durability and performance of the XSEL™ process gauge series, that it comes with an industry leading warranty.

Standard Features

Size: 4½"
Case: Black Pocan®
Ring: Threaded black Pocan®
Wetted Parts: Monel® M400 alloy
Window: Acrylic
Dial: White aluminum

Pointer: Black aluminum, adjustable
Accuracy: ±0.5% of span
 ASME B40.100 Grade 2A
Connection: Lower mount
Restrictor: Standard

Type 262.34 - Dry case
 Type 263.34 - Liquid-filled case

Type	262.34
Size	4½"
Connection	LM
Conn. Size	1/2" NPT
Press. Scale	PSI
30" Hg	9835016
30"-0-15 psi	9835024
30"-0-30 psi	9835032
30"-0-60 psi	9835040
30"-0-100 psi	9835059
30"-0-160 psi	9835067
30"-0-200 psi	9835075
15 psi	9835091
30 psi	9835105
60 psi	9835113
100 psi	9835121
160 psi	9835130
200 psi	9835148
300 psi	9835156
400 psi	9835164
600 psi	9835172
800 psi	9835180
1,000 psi	9835199
1,500 psi	9835202
2,000 psi	9835210
3,000 psi	9835229
5,000 psi	9835237
10,000 psi	
15,000 psi	
Accessory order codes (installed)	
4½ panel kit	+ PM
External zero adjust	+ EXT ADJ
Dampened movement	+ DAMP
Glycerine fill	Type 263.34
Silicone fill	Type 263.34 + SIL

Available Options

- Dampened Movement
- Safety glass or instrument glass window
- Drag pointer (max. reading indicator)
- Cleaned for oxygen service
- Magnetic or inductive contact switches
- Special connections

Applications

- A liquid-filled case and socket restrictor are available for applications with high dynamic pressure pulsations or vibration
- Suitable for corrosive environments and gaseous or liquid media that will not obstruct the pressure system
- Process industry: chemical/petrochemical, power stations, mining, on and offshore, environmental technology, mechanical engineering and plant construction

Abbreviations

LM - Lower mount
 SS - Stainless steel

Stock items shown in blue print

Type 232.34DD

WIKA type 232.34DD direct drive process gauges feature a direct drive, movementless pressure system. With a shock absorbing Bourdon tube design, these gauges are an effective means for guarding against severe shock and vibration applications. The 232.34DD is manufactured in a standard yellow 4½" process gauge style case and comes standard completely equipped with an external zero adjustment and a high 0.5% full scale accuracy.



Standard Features

Size:	4½"	Pointer:	Black aluminum, adjustable
Case:	Yellow thermoplastic, solid front	Accuracy:	±0.5% of span ASME B40.100 Grade 2A ¹⁾
Ring:	Stainless steel	Connection:	Lower mount
Wetted Parts:	X-750 Inconel® / 316 SS	Filter:	Standard, porous filter (25-50 microns)
Window:	Clear acrylic		
Dial:	White aluminum with stop pin at 6 o'clock		

Type	232.34DD
Size	4½"
Connection	LM
Conn. Size	½" NPT
Press. Scale	PSI
-30"-0-30 psi	52386163
-30"-0-60 psi	52386180
-30"-0-150 psi	52386201
-30"-0-300 psi	52386210
30 psi	52386228
60 psi	52386236
100 psi	52386244
160 psi	52386252
200 psi	52386261
300 psi	52386279
500 psi	52386287
1,000 psi	52386295
1,500 psi	52386317
2,000 psi	52386325
3,000 psi	52386333
5,000 psi	52386341
10,000 psi	52386350

Available Options

- Cleaned for use in oxygen service
- Special connection
- 4½" panel mount kit (field assembly)
- Lower back mount & connection
- Weather protection NEMA 4 (IP65)

Applications

- Where high dynamic pressure pulsations or vibration exist
- Suitable for corrosive environments and gaseous or liquid media that will not obstruct the pressure system
- Process industry: chemical/petrochemical, power stations, mining, on and offshore, environmental technology, mechanical engineering and plant construction

Abbreviations
 LM - Lower mount
 SS - Stainless steel

¹⁾ Range 0 / 10,000 psi accuracy ±1.0% of span per ASME B40.100 Grade 1A

Type 212.25

WIKA's type 212.25 4½" and 6" pressure gauges feature a solid-front aluminum case with a hinged ring for easy access to the adjustable pointer. These gauges are supplied with three threaded bolts in the back of the case which line up with existing standard panel hole patterns.



MECHANICAL PRESSURE

Standard Features

Size:	4½" & 6"	Accuracy:	±0.5% of span
Case:	Black-painted aluminum		ASME B40.100 Grade 2A
Ring:	Black-painted aluminum	Connection:	Lower back mount
Wetted Parts:	Copper alloy		
Window:	Flat instrument glass		
Dial:	White aluminum		
Pointer:	Black aluminum, adjustable		

Type	212.25		
Size	4½"	6"	
Connection	LBM		
Conn. Size	1/4" NPT	1/2" NPT	1/2" NPT
Press. Scale	PSI	PSI	PSI
30" Hg	4234970	4235223	4235976
30"-0-15 psi	4234988	4235231	4235984
30"-0-30 psi	4234996	4235240	4235992
30"-0-60 psi	4235002	4235258	4236009
30"-0-100 psi	4235011	4235266	4236017
30"-0-160 psi	4235029	4235274	4236025
30"-0-200 psi	4235037	4235282	4236033
15 psi	4235045	4235291	4236041
30 psi	4235053	4235304	4236050
60 psi	4235061	4235312	4236068
100 psi	4235070	4235321	4236076
160 psi	4235088	4235339	4236084
200 psi	4235096	4235347	4236092
300 psi	4235100	4235355	4236106
400 psi	4235118	4235363	4236114
600 psi	4235126	4235371	4236122
800 psi	4235134	4235381	4236131
1,000 psi	4235142	4235399	4236149
Accessory order codes (installed at factory)			
Restrictor	+ R		

Available Options

- Dampened movement
- Safety glass window
- Cleaned for oxygen service
- Special connections
- Instrument glass window

Applications

- Pressure monitoring panels
- Suitable for gaseous or liquid media that will not obstruct the pressure system or attack copper alloy parts
- Process industry: chemical/petrochemical, power stations, mining, on and offshore, environmental technology, mechanical engineering and plant construction

Abbreviations

LBM - Lower back mount
 SS - Stainless steel

Stock items shown in **blue print**

Type 232.25

WIKA type 232.25 gauges have a glass covered hinged ring front with securing screws as standard. The adjustable pointer is easily accessed under the hinged ring front. Designed for panel mounting, the type 232.25 gauge features 316 SS wetted parts and a one-piece aluminum solid-front safety case design. Well-suited for installations in process panel and control applications, type 232.25 gauges meet ASME Grade 2A accuracy standards.



Standard Features

Size:	4½" & 6"	Pointer:	Black aluminum, adjustable
Case:	Black-painted aluminum	Accuracy:	±0.5% of span
Ring:	Black-painted aluminum		ASME B40.100 Grade 2A
Wetted Parts:	316L SS	Connection:	Lower back mount
Window:	Flat instrument glass		
Dial:	White aluminum		

Type	232.25		
Size	4½"	6"	
Connection	LBM		
Conn. Size	1/4" NPT	1/2" NPT	1/2" NPT
Press. Scale	PSI	PSI	PSI
30" Hg	4235470	4235721	4236220
30"-0-15 psi	4235488	4235739	4236238
30"-0-30 psi	4235496	4235747	4236246
30"-0-60 psi	4235509	4235755	4236254
30"-0-100 psi	4235517	4235763	4236262
30"-0-160 psi	4235525	4235771	4236271
30"-0-200 psi	4235533	4235780	4236280
15 psi	4235541	4235798	4236298
30 psi	4235551	4235801	4236301
60 psi	4235569	4235810	4236319
100 psi	4235577	4235828	4236327
160 psi	4235585	4235836	4236335
200 psi	4235593	4235844	4236343
300 psi	4235606	4235852	4236351
400 psi	4235614	4235861	4236361
600 psi	4235622	4235879	4236379
800 psi	4235631	4235887	4236387
1,000 psi	4235640	4235895	4236395
1,500 psi	4235658	4235909	4236408
2,000 psi	4235666	4235917	4236416
3,000 psi	4235674	4235925	4236424
5,000 psi	4235682	4235933	4236432
10,000 psi	4235691	4235941	4236441
15,000 psi	4235703	4235950	4236450
20,000 psi	4235711	4235968	4236468
Accessory order codes (installed at factory)			
Restrictor	+ R		

Available Options

- Dampened movement
- Safety glass window
- Cleaned for oxygen service
- Special connections
- Instrument glass window

Applications

- Pressure monitoring panels
- Suitable for corrosive gaseous or liquid media that will not clog the pressure system or attack 316L SS parts
- Process industry: chemical/petrochemical, power stations, mining, on and offshore, environmental technology, mechanical engineering and plant construction

Abbreviations

LBM - Lower back mount
SS - Stainless steel

Stock items shown in blue print

Type 4XX.12

WIKA type 422.12 and 432.12 Sealgauges offer superior protection from viscous and crystallizing media. Type 422.12 features carbon steel wetted parts, while type 432.12 offers the corrosion protection of 316 SS wetted parts. Each model is supplied with a standard black cast iron case and standard 1/2" NPT female connection.



MECHANICAL PRESSURE

Standard Features

Size:	4" & 6"	Window:	Flat instrument glass
Case:	Black-painted cast iron	Dial:	White aluminum
Ring:	Black-painted stainless steel	Pointer:	Black aluminum, adjustable
Wetted Parts:	(41x.12) carbon steel, stainless steel & Buna-N	Accuracy:	±1.5% of span
	(43x.12) SS & Buna-N	Connection:	Lower mount

Overpressure Safety:

- Ranges ≤ 6 psi: 5 x full scale value
- Ranges > 6 psi: 3 x full scale value, max 600 psi protection

Type	422.12		432.12	
Size	4"	6"	4"	6"
Connection	LM			
Conn. Size	1/2" NPT Female			
Press. Scale	PSI	PSI	PSI	PSI
30" Hg			9736336	
30"-0-15 psi				
30"-0-30 psi			9740087	
30"-0-60 psi			9740095	
30"-0-100 psi			9744105	
30"-0-160 psi				
30"-0-200 psi				
10 psi	9744113			
15 psi			8683581	
30 psi	8558337		8558310	
60 psi	8681791		8683590	
100 psi	8558345		8657360	
160 psi			8683603	
200 psi	8681813		9744121	
300 psi			8547092	
400 psi			9697565	
600 psi	9744139		8681236	
5" H ₂ O				
10" H ₂ O				
15" H ₂ O				
30" H ₂ O				
60" H ₂ O				
100" H ₂ O				
200" H ₂ O				

Available Options

- Open flange connections
- Liquid-filled case design
- Special wetted materials
- Electrical alarm contacts

(Dry cases not field fillable)

Applications

- With liquid-filled case for applications with high dynamic pressure pulsations or vibration
- Suitable for corrosive environments and gaseous or liquid media that will not obstruct the pressure system
- Process industry: chemical/petrochemical, power stations, mining, on and offshore, environmental technology, mechanical engineering and plant construction

Abbreviations

LM - Lower mount
SS - Stainless steel

Stock items shown in blue print

Type 43X.50

WIKA type 432.50 Sealgauges feature all stainless steel construction and are built to withstand corrosive, highly viscous and crystallizing media. This Sealgauge is ideal for applications in harsh environments such as pulp and paper processing, chemical, petrochemical, and in water and sewage treatment plants.



Type 432.50 - dry case
Type 433.50 - filled case

Standard Features

Size:	4" & 6"	Dial:	White aluminum
Case:	304 SS	Pointer:	Black aluminum, adjustable
Ring:	304 SS	Accuracy:	±1.5% of span
Wetted Parts:	316L SS, Teflon®, Duratherm	Connection:	Lower mount
Window:	Safety glass		

Overpressure Safety:

5 x full scale value, max 600 psi protection

Type	432.50 (Dry)		433.50 (Filled)	
Size	4"	6"	4"	6"
Connection	LM			
Conn. Size	1/2" NPT Female			
Press. Scale	PSI	PSI	PSI	PSI
30" Hg				
30"-0-15 psi				
30"-0-30 psi	9744147			
30"-0-60 psi	9744155			
30"-0-100 psi				
30"-0-160 psi	9744164			
30"-0-200 psi				
10 psi			8737134	
15 psi				
30 psi	8683360		9697603	
60 psi	8683379		8605548	
100 psi	8597952		8511950	
160 psi	8683387		8737118	
200 psi	9744172		8691320	
300 psi	8683409		8737126	
400 psi	9697581		8549176	
600 psi	9697599		8503370	
5" H ₂ O				
10" H ₂ O				
15" H ₂ O				
30" H ₂ O				
60" H ₂ O				
100" H ₂ O				

Stock items shown in blue print

Available Options

- Open flange connections
- Case filling
- Special wetted materials
- Electrical alarm contacts
- Transmitters

(Dry cases not field fillable.)

Applications

- With liquid-filled case for applications with high dynamic pressure pulsations or vibration
- Suitable in corrosive environments for gaseous, liquid or highly viscous media.
- Process industry: chemical/petrochemical, power stations, mining, on and offshore, environmental technology, mechanical engineering and plant construction

Abbreviations

LM - Lower mount
SS - Stainless steel

Type A2G-10

This low pressure differential pressure gauge is designed to measure dry, clean non-aggressive gases and air. This instrument is ideally suited to measure differential pressure in filtration systems, pressure monitoring for HVAC, air handlers and ventilation systems and for pressure monitoring of clean rooms, gas scrubbers and dust collection systems.



Standard Features

Size:	4½"	Pointer:	Black aluminum
Case:	High-impact polycarbonate	Accuracy:	± 3% of span
Wetted Parts:	Silicone rubber, polycarbonate	Connection:	Lower or back mount
Window:	Polycarbonate	Mounting:	3 self-tapping mounting screws (standard)
Dial:	White aluminum		

Type	A2G-10	
Size	4½"	
Conn. Size	2 x 1/8" Hose Barb	
Connection	Lower	Back
Mounting	Surface Mount	Panel Mount
-0.1/+0.1 InWC	50677012	50676814
-0.2/+0.2 InWC	50677039	50676822
-0.5/+0.5 InWC	50677055	50676831
1/+1 InWC	50807132	50807099
-2/+2 InWC	50807145	50807102
-4/+4 InWC	50807153	50807111
-6/+6 InWC	50807161	50807129
0/0.25 InWC	50677063	50676857
0/0.4 InWC	50677098	50676865
0/0.5 InWC	50677080	50676873
0/1 InWC	50556673	50676881
0/2 InWC	50556681	50676890
0/3 InWC	50556690	50676903
0/4 InWC	50556703	40246582
0/5 InWC	50686178	50676911
0/6 InWC	50556738	40214583
0/8 InWC	50556746	50676920
0/10 InWC	50556754	50676938
0/12 InWC	40214605	50676946
0/15 InWC	50556762	40246604
0/20 InWC	50556771	50676954
0/25 InWC	50556789	50676962
0/30 InWC	50677101	50676971
0/40 InWC	50677110	50676989
0/50 InWC	50677128	50676997

Available Options

- Other pressure units (Pa, kPa, mmWC, cmWC, mbar) available in equivalent ranges
- Custom artwork with custom logo - background colors available upon request
- Compression fitting adaptor

Applications

- For dry, clean, non-aggressive gases, usually air
- Fan and blower monitoring
- Differential pressure monitoring in filters
- Overpressure monitoring in cleanrooms

Stock items shown in blue print

Type A2G-15

This low pressure differential pressure gauge is designed to measure dry, clean non-aggressive gases and air. This instrument is ideally suited to measure differential pressure in filtration systems, pressure monitoring for HVAC, air handlers and ventilation systems and for pressure monitoring of clean rooms, gas scrubbers and dust collection systems.



Standard Features

Size:	4½"	Pointer:	Black aluminum
Case:	High-impact polycarbonate	Accuracy:	± 3% of span
Wetted Parts:	Silicone rubber, polycarbonate	Connection:	Lower or back mount
Window:	Polycarbonate	Mounting:	3 self-tapping mounting screws (standard)
Dial:	White aluminum		

Type	A2G-15			
Size	4½"			
Conn. Size	2 x G1/8 Female			
Connection	Lower		Back	
Mounting	Surface Mount		Panel Mount	
Elec. Output Signal	4 ... 20 mA 2-wire	0 ... 10 V 3-wire	4 ... 20 mA 2-wire	0 ... 10 V 3-wire
-0.1/+0.1 InWC	50693522	50693921	50692798	50693166
-0.2/+0.2 InWC	50693531	50693930	50692801	50693191
-0.5/+0.5 InWC	50693549	50693956	50692810	50693204
1/+1 InWC	50807366	50807412	50807218	50807251
-2/+2 InWC	50807374	50807447	50807226	50807277
-4/+4 InWC	50807382	50807463	50807234	50807293
-6/+6 InWC	50807391	50807471	50807242	50807307
0/0.25 InWC	50693557	50693964	50692828	50693212
0/0.4 InWC	50693565	50693972	50692836	50693221
0/0.5 InWC	50693573	50693999	50692844	50693239
0/1 InWC	50693581	50694006	50692852	50693247
0/2 InWC	50693590	50694022	50692861	50693255
0/3 InWC	50693603	50694031	50692879	50693271
0/4 InWC	50693611	50694049	50692887	50693280
0/5 InWC	50693620	50694057	50692895	50693298
0/6 InWC	50693638	50694065	50692909	50693301
0/8 InWC	50693646	50694090	50692917	50693310
0/10 InWC	50693794	50694103	50692925	50693336
0/12 InWC	50693808	50694120	50692933	50693344
0/15 InWC	50693816	50694146	50692941	50693361
0/20 InWC	50693841	50694154	50692950	50693379
0/25 InWC	50693859	50694162	50692968	50693387
0/30 InWC	50693867	50694171	50692976	50693395
0/40 InWC	50693875	50694189	50692984	50693409
0/50 InWC	50693883	50694197	50692992	50693417

Available Options

- Other pressure units (Pa, kPa, mmWC, cmWC, mbar) available in equivalent ranges
- Custom artwork with custom logo - background colors available upon request
- Compression fitting adaptor

Applications

- For dry, clean, non-aggressive gases, usually air
- Fan and blower monitoring
- Differential pressure monitoring in filters
- Overpressure monitoring in cleanrooms

Stock items shown in blue print

Type 611.10

WIKA type 6X1.10 low pressure gauges are extremely sensitive and highly accurate. The capsule element pressure system is designed to measure pressure and vacuum of gaseous media from as low as 10" H₂O to 275" H₂O (10 psi). The finely polished nickel-silver pinion gear and shaft of the movement ensure repeatable accuracy.



Standard Features

Size:	2½"	Pointer:	Black aluminum
Case:	Black-painted steel	Accuracy:	±1.5% of span
Wetted Parts:	Copper alloy		ASME B40.100 Grade B
Window:	Snap-in acrylic	Connection:	Lower or center back mount
Dial:	White aluminum		

Type		611.10	
Size		2½"	
Connection		LM	CBM
Conn. Size		1/4" NPT	
" H ₂ O	mm H ₂ O		
30 Vac	760	9852344	9851852
60 Vac	1500	9748321	9748339
100 Vac	2500	9747473	9747465
" H ₂ O	mm H ₂ O		
15	380	9851682	9851860
30	760	9851690	9855785
60	1500	9851704	9803432
100	2500	9851810	9851879
200	5000	9851828	9851887
oz./sq. in.	mm H ₂ O		
10	440	9851771	
15	660	9851780	
20	880	9851798	
30	1320	9851747	9851917
35	1540	9851801	9857273
60	2640	9851755	9803548
oz./sq. in.	" H ₂ O		
20	34	9851720	9857281
32	55	9851739	9855793
3 psi		9851925	9851836
5 psi		9851933	9851844
10 psi		4204212	4204221
Accessory order codes (installed at factory)			
Front flange, chrome		+ FF C	
Front flange, black		+ FF B	
Restrictor		+ R	

Available Options

- Rear flange (2½" only)
- Vacuum and overpressure safety
- Instrument or safety glass window
- Cleaned for oxygen service
- Adjustable red min/max pointer on window
- Other connections
- 2" case size
- U-clamp panel mount option
- Restrictor
- Stainless steel case

Applications

- Fluid medium, gaseous or dry, which does not clog connection port or corrode copper alloy

Example: low pressure pneumatic systems

Abbreviations

CBM - Center back mount
 LM - Lower mount
 SS - Stainless steel

Stock items shown in **blue print**

Type 612.20

WIKA type 612.20 low pressure gauges feature a copper alloy capsule element that is designed to measure pressure and vacuum of gaseous media from as low as 2.5" H₂O to 275" H₂O (10 psi). The 4" dial size allows easy reading from a distance. The finely polished nickel-silver pinion gear and shaft of the movement ensure repeatable accuracy.



Standard Features

Size:	4"	Pointer:	Black aluminum
Case:	304 SS	Accuracy:	±2/1/2% of span
Wetted Parts:	Copper alloy		ASME B40.100 Grade B
Window:	Instrument glass	Connection:	Lower mount
Dial:	White aluminum		

Type		612.20
Size		4"
Connection		LM
Conn. Size		1/4" NPT
" H ₂ O	mm H ₂ O	
30 Vac	760	9747724
60 Vac	1500	
100 Vac	2500	
" H ₂ O	mm H ₂ O	
15	380	9747732
30	760	9747740
60	1500	9747758
100	2500	9747766
200	5000	9747775
oz./sq. in.	mm H ₂ O	
10	440	
15	660	
20	880	
30	1320	
35	1540	
60	2640	
oz./sq. in.	" H ₂ O	
20	34	
32	55	
3 psi		9747783
5 psi		9747791
10 psi		4246684
Accessory order codes (installed at factory)		
Front flange, SS		+ FF S
Restrictor		+ R

Available Options

- Rear flange
- Vacuum and over-pressure safety
- Acrylic or safety glass window
- Cleaned for oxygen service
- Adjustable red min/max pointer on window
- 2½" and 6" nominal case sizes
- Lower back mount connection
- Other connections
- Front flange
- U-clamp panel mount option
- Restrictor

Applications

- Low pressure pneumatic systems
- Suitable for fluid medium, gaseous or dry that does not corrode copper alloy

Abbreviations

LM - Lower mount
SS - Stainless steel

Stock items shown in blue print

Type 6X2.34

WIKA type 6X2.34 low pressure process gauges offer accurate readings in harsh ambient conditions. They are able to measure the pressure of gaseous media from as low as 10" H₂O to 275" H₂O (10 psi) or other equivalent units of pressure or vacuum. The finely polished nickel-silver pinion gear and shaft of the movement ensure repeatable accuracy.



Standard Features

Size:	4½"	Dial:	White aluminum
Case:	Black thermoplastic	Pointer:	Black aluminum, adjustable
Ring:	Threaded thermoplastic	Accuracy:	±2/1/2% of span
Wetted Parts:	612.34 - copper alloy 632.34 - 316L SS	Connection:	ASME B40.100 Grade A Lower mount
Window:	Acrylic		

Type		612.34	632.34
Size		4½"	
Connection		LM	
Conn. Size		1/4" NPT	
Outer Scale	Inner Scale		
10 "H ₂ O	6 oz./in ²	4217063	4217187
15 "H ₂ O	9 oz./in ²	4217071	4217195
20 "H ₂ O	12 oz./in ²	4217080	4217209
30 "H ₂ O	18 oz./in ²	4217098	4217217
40 "H ₂ O	24 oz./in ²	4217101	4217225
60 "H ₂ O	35 oz./in ²	4217110	4217233
80 "H ₂ O	45 oz./in ²	4217128	4217241
100 "H ₂ O	57 oz./in ²	4217136	4217250
150 "H ₂ O	90 oz./in ²	4217144	4217268
5 psi	10 "Hg	4217039	4217152
8 psi	16 "Hg	4217047	4217161
10 psi	20 "Hg	4217055	4217179
Accessory order codes (installed at factory)			
4½" panel kit		+ PM	
Restrictor		+ R	

Stock items shown in **blue print**

Available Options

- Monel® wetted parts (Type 662.34)
- Vacuum or over-pressure safety
- Flat glass and safety glass window (not with case filling)
- Adjustable red min/max pointer on window
- Silicone case filling (633.34) (40" WC and up)
- Other connections
- Panel mount kit
- Restrictor

Applications

- Where measurement of low pressures is needed
- Suitable for corrosive environments and gaseous or liquid media that will not obstruct the pressure system
- Process industry: chemical/petrochemical, power stations, mining, on and offshore, environmental technology, mechanical engineering and plant construction

Abbreviations

LM - Lower mount
SS - Stainless steel

Type 632.50

WIKA type 632.50 low pressure gauges offer the corrosion resistance of 316 SS wetted parts and is able to measure pressure and vacuum of gaseous media from as low as 1" H₂O to 275" H₂O (10 psi). The finely polished nickel-silver pinion gear and shaft of the movement ensure repeatable accuracy.



Standard Features

Size:	4"	Pointer:	Black aluminum
Case:	304 SS	Accuracy:	±2/1/2% of span
Wetted Parts:	316L SS		ASME B40.100 Grade B
Window:	Safety glass	Connection:	Lower mount
Dial:	White aluminum		

Type	632.50
Size	4"
Connection	LM
Conn. Size	1/2" NPT
5-0-5 "H ₂ O	9804439
10-0-10 "H ₂ O	9804447
15-0-15 "H ₂ O	9804455
15 "H ₂ O-0-5psi	9804412
15 "H ₂ O	9804323
20 "H ₂ O	9804471
30 "H ₂ O	9804315
60 "H ₂ O	9804498
100 "H ₂ O	9859314
200 "H ₂ O	9804501
5 psi	9804307
10 psi	9804420
Accessory order codes (installed)	
Front flange, SS	+ FF S
Restrictor	+ R

Stock items shown in blue print

Available Options

- Rear flange
- Vacuum and overpressure safety
- Inductive alarm contacts
- Cleaned for oxygen service
- Adjustable red min/max pointer on window
- Silicone case filling (40" WC and up)
- Other connections
- Lower back mount connection
- 2½" and 6" nominal case size
- Front flange

Applications

- Robust design and weather protection, suitable for outdoor use
- Suitable for dry, gaseous media that will not attack 316 SS parts
- Process industry: chemical/petrochemical, power stations, mining, on and offshore, environmental technology, mechanical engineering and plant construction

Abbreviations

LM - Lower mount
 SS - Stainless steel
 LBM - Lower back mount

Type 700.04

This piston-style differential pressure gauge is designed for use with clean liquid or gaseous media where high differential pressure/static process pressures are required. Type 700.04 is suitable for measuring pressure drops across a variety of devices, including filters, strainers, separators and heat exchangers.



Standard Features

Size:	2½" & 4½"	Window:	Acrylic
Case:	Black thermoplastic	Dial:	White aluminum
Wetted Parts:	Ceramic magnet, 316 SS spring, Viton® O-rings, sensor housing (see table)	Pointer:	Black aluminum
		Accuracy:	±2% of span (ascending pressure only)
		Connection:	Back mount

6000 psig Max. Safe Working Pressure

Type	700.04			
Size	2½"	4"	2½"	4"
Conn. Size	2 x 1/4" NPT Female, Back			
Sensor Housing	Black-anodized aluminum		316L SS	
5 psid	4390954	4390632	4390675	50334085
10 psid	4375242	4371866	4368084	4372170
20 psid	5375250	4368092	4371816	4372188
25 psid	4375268	4371883	4371824	4272196
30 psid	4390616	4390658	4390691	4390739
50 psid	4375276	4371891	4371832	4272209
60 psid	50420267	4390666		50441647
75 psid	4375285	4371905	4371840	43722147
100 psid	4372933	4371913	4371858	4372162
Accessory order codes (installed at factory)				
Safety glass	+ SG			
Wall/pipe mount kit	+ MKIT			
Drag pointer	+ DP			
Glycerine fill	Type 703.04			

Stock items shown in **blue print**

Available Options

- ½" NPT female with adaptors (#203963)
- In-line connections (side/end connection)
- Bi-directional reading
- Reversed pressure ports: high (+) on left, low (-) on right (facing gauge)
- Buna-N or EPDM O-rings
- Reed switch with flying leads (SPST and SPDT)
- Wall / pipe - mounting brackets
- Safety glass window

Applications

- For use in measurement applications requiring high differential/static process pressures
- Suitable for measuring pressure drops across filters, strainers, separators, etc.

Abbreviations

SPDT - Single pole, double throw
 SPST - Single pole, single throw
 SS - Stainless steel

Type 700.05

This diaphragm-style differential pressure gauge is suited for use in applications requiring low/medium differential and medium/high process pressure media. Type 700.05 is intended for measuring pressure drops across filters, strainers, separators, heat exchangers and gas recovery systems.



Standard Features

Size:	2½" & 4½"	Dial:	White aluminum
Case:	Black thermoplastic	Pointer:	Black aluminum
Wetted Parts:	Ceramic magnet, 316 SS spring, Buna-N O-rings, sensor housing (see table)	Accuracy:	±2% of span
Window:	Acrylic	Connection:	Back mount

3000 psig Max. Safe Working Pressure

Type	700.05			
Size	2½"	4"	2½"	4"
Conn. Size	2 x 1/4" NPT Female, Back			
Sensor Housing	Black-anodized aluminum		316L SS	
0/50 "H ₂ O	4375306	4375446	4375586	4375722
0/75 "H ₂ O	4375315	4375455	4375595	4375730
0/100 "H ₂ O	4375323	4375463	4375608	4375748
0/200 "H ₂ O	4375331	4375471	4375616	4375756
0/300 "H ₂ O	4375349	4375489	4375625	4375765
0/400 "H ₂ O	4375357	4375497	4375633	4375773
0/5 psid	4375366	4375501	4375641	4375781
0/10 psid	4375374	4375519	4375659	4375799
0/15 psid	4375382	4375527	4375667	4375803
0/25 psid	4375390	4375536	4375676	4375811
0/30 psid	4375404	4375544	4375684	4375829
0/50 psid	4375412	4375552	4375692	4375837
0/75 psid	4375420	4375560	4375706	4375846
0/100 psid	4375438	4375578	4375714	4375854
Accessory order codes (installed at factory)				
Safety glass	+ SG			
Wall/Pipe mount kit	+ MKIT			
Drag pointer	+ DP			
Glycerine fill	Type 703.05			

Available Options

- ½" NPT female with adaptors (#203963)
- ¼" NPT female top and bottom mount
- Safety glass window
- Case filling - glycerine or silicone
- Viton® membrane and O-rings
- Wall / pipe - mounting brackets

Applications

- For use in measurement applications requiring high differential/static process pressures
- Suitable for applications with particulate matter present in liquid/gas media or when separation of the media is required

Abbreviations

SS - Stainless steel

Stock items shown in blue print

Mechanical Pressure > Differential Pressure Gauges > 712.15

Type 712.15

WIKA's type 712.15 differential pressure "Cryo Gauge" is designed for liquid level measurement in particular for the cryogenic industry.

Standard Features

Size: 6"
Case: 304 SS with polished SS front flange
Wetted Parts: Copper alloy measuring cell with 316L compression springs and NBR separating diaphragm

Window: Polycarbonate
Dial: White aluminum
Pointer: Black aluminum
Accuracy: ±2.5% of span
Connection: Lower mount



750 psig max. working pressure

Type	712.15
Size	6"
Connection	LM
Conn. Size	2 x 1/4" NPT Female
Mounting	Panel Mount
0/50"WC	50696246
0/100"WC	50696262
0/150"WC	50696271
0/200"WC	50696289
0/250"WC	50696297
0/300"WC	50696301
0/350"WC	50696319
0/400"WC	50696327
0/450"WC	50696335
0/500"WC	50696343
0/600"WC	50696351
0/700"WC	50696360
0/800"WC	50696378
0/900"WC	50696386
Accessory order codes	
Safety glass window	SG
Universal wall-/pipe mount kit	MKIT
"H"- mounting bracket	H-BRKT
"C"- mounting bracket	C-BRKT

Available Options

- 3-way manifold w/integrated working pressure gauge
- Magnetic or inductive alarm contacts
- Single and dual Reed switches
- 4-20 mA transmitter output
- Variety of mounting devices
- 316 SS wetted parts (712.16)
- 4" nominal case size

Applications

- Level measurement in closed tanks, particularly in cryotechnology
- Filter monitoring
- Monitoring and control of pumps
- For gaseous and liquid media that are not highly viscous and have no suspended solids

Abbreviations

LM - Lower mount
 SS - Stainless steel

Stock items shown in blue print

DIFFERENTIAL PRESSURE GAUGES

Mechanical Pressure > Differential Pressure Gauges > 712.25DP

Type 712.25DP

Type 712.25DP 4½" and 6" gauges feature a tough black-painted aluminum case with brass wetted parts. They feature a dual Bourdon tube system and a special subtracting movement drives one pointer to display the differential pressure. The built-in rear flange matches up to existing mounting holes without any modifications. These gauges are suitable for all gaseous and liquid media that will not obstruct pressure systems or attack copper alloy parts.



Standard Features

Size:	4½" & 6"	Dial:	White aluminum
Case:	Black epoxy-coated aluminum	Pointer:	Black aluminum
Ring:	Black epoxy-coated aluminum	Accuracy:	±2/1/2% of span
Wetted Parts:	Copper alloy		ASME B40.100 Grade A
Window:	Instrument glass	Connection:	Lower mount

Type		712.25DP	
Size		4½"	6"
Connection		LM	
Conn. Size		2 x 1/4" NPT	
Diff. Range	Max. Static Press.		
15 psid	15 psig		
30 psid	30 psig	4241487	4241819
60 psid	60 psig	4241495	4241827
100 psid	100 psig	4241509	4241835
160 psid	160 psig	4241715	4241843
200 psid	200 psig	4241585	4241851
300 psid	300 psig		
400 psid	400 psig	4241541	4241879
600 psid	600 psig		
800 psid	800 psig		
1000 psid	1000 psig	4241568	4241895
15/0/15 psid	30 psig		
30/0/30 psid	60 psig		
50/0/50 psid	100 psig		
100/0/100 psid	200 psig		
150/0/150 psid	300 psig		
200/0/200 psid	400 psig		
400/0/400 psid	800 psig		
500/0/500 psid	1000 psig		
Accessory order codes (installed at factory)			
Restrictor		+ R	

Available Options

- Restrictor

Applications

- Measurement of pressure differential of two applied pressures
- Suitable for all gaseous and liquid media that will not obstruct the pressure system or attack copper alloy parts

Abbreviations

LM - Lower mount
SS - Stainless steel

Stock items shown in blue print

Type 712.25DX

Type 712.25DX 4½" and 6" gauges feature a tough black-painted aluminum case with brass wetted parts. Type 712.25DX gauges feature two independent pressure systems and a special movement drives one red pointer and one black pointer to display two pressure readings on the dial. The built-in rear flange matches up to existing mounting holes without any modifications. The 712.25DX is suitable for all gaseous and liquid media that will not obstruct the pressure system or attack copper alloy parts.



Standard Features

Size:	4½" & 6"	Dial:	White aluminum
Case:	Black epoxy-coated aluminum	Pointer:	Black aluminum
Ring:	Black epoxy-coated aluminum	Accuracy:	±2/1/2% of span
Wetted Parts:	Copper alloy		ASME B40.100 Grade A
Window:	Instrument glass	Connection:	Lower mount

Type		712.25DX	
Size		4½"	6"
Conn. Size		2 x 1/4" NPT	
Diff. Range	Max Static		
15 psi	19 psi	4241657	4241738
30 psi	39 psi	4241665	4241746
60 psi	78 psi	4241673	4241754
100 psi	130 psi	4241681	4241762
160 psi	208 psi		
200 psi	260 psi		
300 psi	390 psi	4241690	4241771
400 psi	520 psi		
600 psi	780 psi		
800 psi	1,040 psi		
1,000 psi	1,300 psi	4241720	4241801
Accessory order codes (installed at factory)			
Restrictor		+ R	

Available Options

- Restrictor

Applications

- Measurement and indication of two applied pressures
- Suitable for all gaseous and liquid media that will not obstruct the pressure system or attack copper alloy parts

Abbreviations

LM - Lower mount
SS - Stainless steel

Stock items shown in blue print.

DIFFERENTIAL PRESSURE GAUGES

Mechanical Pressure > Differential Pressure Gauges > 732.25

Type 732.25

This opposed membrane/liquid-filled sensor element differential pressure gauge is for applications requiring high differential/high process pressures. The 732.25 is used in a variety of industrial uses, including rotating equipment systems and/or corrosive environments in liquid or gaseous media.



Standard Features

Size:	4½" & 6"	Window:	Acrylic
Case:	Black epoxy-coated aluminum	Dial:	White aluminum
Ring:	Polished SS	Pointer:	Black aluminum
Wetted Parts:	316L SS sensor housing, Monel® membrane, and PTFE O-ring	Accuracy:	±1% of span ASME B40.100 Grade 1A
		Connection:	Back mount

Type	732.25	
Size	4½"	6"
Conn. Size	2 x 1/4" NPT Female, Back	
100 "H ₂ Od		
150 "H ₂ Od		
200 "H ₂ Od		
300 "H ₂ Od		
400 "H ₂ Od		
15 psid	4375862	4275926
30 psid	4275870	4375935
60 psid	4375888	4375943
100 psid	4375896	4375951
230 psid	4375900	4375969
300 psid	4375918	4375977
400 psid		
500 psid		
600 psid		
Accessory order codes (installed at factory)		
Safety glass window	+ SG	
Glycerine fill	Type 733.25	

Available Options

- Case filling
- Top and bottom connection
- Wall/pipe mounting kit (only available in connection with top / bottom mount)
- ½" NPT female adaptors (#203963)
- 304 SS case material
- Dial for flow applications (square root)

Applications

- For use in measurement applications requiring high differential / static process pressures
- For corrosive environments with either liquid or gaseous media

Abbreviations

LM - Lower mount
SS - Stainless steel

Stock items shown in blue print.

Type 732.26

This opposed membrane/liquid-filled sensor element differential pressure gauge is for applications requiring low differential/medium static process pressures. The 732.26 is typically used for a variety of industrial uses, including cryogenic gases and/or corrosive environments in liquid or gaseous media.



Standard Features

Size:	4½" & 6"	Window:	Acrylic
Case:	Black epoxy-coated aluminum	Dial:	White aluminum
Ring:	Polished SS	Pointer:	Black aluminum
Wetted Parts:	316L SS sensor housing, 316 SS membrane, and PTFE O-ring	Accuracy:	±1% of span ASME B40.100 Grade 1A
Dial:	White aluminum with black lettering	Connection:	Top/bottom mount

600 psig Max. Safe Working Pressure

Handwritten calibration report standard

**Cleaned for oxygen service,
with "USE NO OIL" on dial**

Type	732.26	
Size	4½"	6"
Conn. Size	2 x 1/4" NPT Female, Top/Btm	
100 "H ₂ O _d	4375986	4374246
150 "H ₂ O _d	4375994	4376036
200 "H ₂ O _d	4376001	4376044
300 "H ₂ O _d	4376019	4376052
400 "H ₂ O _d	4376027	4376060
15 psid		
30 psid		
60 psid		
100 psid		
230 psid		
300 psid		
400 psid		
500 psid		
Accessory order codes (installed at factory)		
Safety glass window	+ SG	

Available Options

- Case filling Halocarbon® (only for O₂ service); other case fillings (glycerine or silicone oil) are available, but not for O₂ service (without * use no oil* on dial)
- Wall/pipe mounting kit
- C-bracket mounting kit (#2353275)
- H-bracket mounting kit (#2398784)
- Special dials for liquid level measurement
- ½" NPT female adaptors (#203963)
- 304 SS case material
- Safety glass window

Applications

- For measurement in applications requiring low to medium differential and / or static process pressures
- For cryogenic gases or corrosive environments with either liquid or gaseous media

Stock items shown in **blue** print.

Type 312.20

Extremely sensitive and highly accurate, WIKA type 312.20 test gauges are excellent for instrument shops, gauge repair and calibration shops, testing laboratories and other applications demanding high precision and consistent results. Type 312.20 test gauges feature adjustable knife-edge pointers and mirror bands on the dial to assure precise readings and to eliminate parallax error.



Standard Features

Size:	6"	Pointer:	Black aluminum, adjustable knife-edge
Case:	304 SS	Movement:	Brass with nickel-silver pinion gears and shaft
Ring:	Polished stainless steel	Accuracy:	±0.25% of span ASME B40.100 Grade 3A
Wetted Parts:	Copper alloy	Connection:	Lower mount
Window:	Safety glass		
Dial:	White aluminum, with mirrored band		

Type	312.20	
Size	6"	
Connection	LM	
Conn. Size	1/4" NPT	1/2" NPT
Press. Scale	PSI	PSI
30" Hg	9746859	9747163
30"-0-15 psi		
30"-0-30 psi		
30"-0-60 psi		
30"-0-100 psi		
30"-0-160 psi		
30"-0-200 psi	9651454	
15 psi	9746867	9747171
30 psi	9746875	9747189
60 psi	9746884	9747197
100 psi	9746892	9747201
160 psi	9746905	9747219
200 psi	9746914	9747227
300 psi	9746922	9747235
400 psi	9746930	9747244
600 psi	9746948	9747252
800 psi	9746956	9747260
1,000 psi	9746965	9747278
1,500 psi	9746973	9747286
2,000 psi	9746981	9747295
3,000 psi	9746999	9747308
5,000 psi	9747006	9747316
10,000 psi	9747015	9747325
Accessory order codes (installed at factory)		
Front flange, SS	+ FF	
Rear flange, SS	+ RF	
Restrictor	+ R	

Available Options

- Front flange, stainless steel
- Rear flange, stainless steel
- Cleaned for oxygen service
- Special connections

Applications

- Calibration and testing laboratories
- Suitable for gaseous or liquid media that will not obstruct the pressure system or corrode copper alloy wetted parts

Abbreviations

LM - Lower mount
SS - Stainless steel

Stock items shown in blue print.

Type 332.30

Type 332.30 test gauges feature a solid front, blow-out back safety case design and adjustable knife-edge pointers. The mirror bands on the dial assure precise readings and eliminate parallax error. Extremely sensitive and highly accurate, WIKA type 332.30 test gauges are excellent for instrument shops, gauge repair and calibration shops, testing laboratories and other applications demanding high precision and consistent results.



Standard Features

Size:	6"	Pointer:	Black aluminum, adjustable knife-edge
Case:	304 SS, solid-front	Movement:	Stainless steel
Ring:	Polished stainless steel	Accuracy:	±0.25% of span
Wetted Parts:	316L SS	Connection:	ASME B40.100 Grade 3A
Window:	Safety glass		
Dial:	White aluminum, with mirrored band		

Type	332.30
Size	6"
Connection	LM
Conn. Size	1/2" NPT
Press. Scale	PSI
30" Hg	50719092
30"-0-15 psi	
30"-0-30 psi	
30"-0-60 psi	
30"-0-100 psi	
30"-0-160 psi	
30"-0-200 psi	
15 psi	
30 psi	
60 psi	
100 psi	4207408
160 psi	4277416
200 psi	50407848
300 psi	4248946
400 psi	50046128
600 psi	4286112
800 psi	
1,000 psi	50179691
1,500 psi	50046136
2,000 psi	
3,000 psi	4282559
5,000 psi	9744309
10,000 psi	
Accessory order codes (installed)	
Front flange, SS	+ FF
Restrictor	+ R

Available Options

- Front flange, stainless steel
- Rear flange, stainless steel
- Cleaned for oxygen service
- Special connections

Applications

- Calibration and testing laboratories
- Suitable for gaseous or liquid media that will not obstruct the pressure system or corrode stainless steel wetted parts

Abbreviations

LM - Lower mount
SS - Stainless steel

Stock items shown in **blue** print.

Type 332.54

WIKA type 332.54 inspector's test gauges are convenient for field calibrations. They have an accuracy of $\pm 0.25\%$ which meets ASME B40.100 Grade 3A. The mirrored band on the dial and the knife-edge pointer make it easy to take accurate readings from the gauge. Type 332.54 test gauges are supplied standard with a padded, nylon carrying pouch.



Standard Features

Size:	4"	Pointer:	Black aluminum, adjustable knife-edge
Case:	304 SS	Movement:	Stainless steel
Ring:	Polished stainless steel	Accuracy:	$\pm 0.25\%$ of span (ASME B40.1 Grade 3A) 0/30" Hg to 600 psi and 2,000 psi to 20,000 psi; $\pm 0.5\%$ of span (ASME B40.1 Grade 2A) 600>2,000 psi
Wetted Parts:	316L SS	Connection:	Lower mount
Window:	Safety glass		
Dial:	White aluminum, with mirrored band		

Type	332.54
Size	4"
Connection	LM
Conn. Size	1/4" NPT
Press. Scale	PSI
30" Hg	4220013
30"-0-15 psi	4362336
30"-0-30 psi	4255232
30"-0-60 psi	4333781
30"-0-100 psi	4237961
30"-0-160 psi	4213176
30"-0-200 psi	4200741
15 psi	4220021
30 psi	4220030
60 psi	4220048
100 psi	4220056
160 psi	4220064
200 psi	4220072
300 psi	4220081
400 psi	4220099
600 psi	4220102
800 psi	
1,000 psi	4220111
1,500 psi	4246004
2,000 psi	4249250
3,000 psi	4237979
5,000 psi	4243269
10,000 psi	50044796
Accessory order codes (installed)	
Rear flange, SS	+ RF
Restrictor	+ R

Available Options

- Special connections
- Instrument glass window
- Cleaned for oxygen service

Applications

- Inspector's test gauge
- Testing and calibration of other pressure measuring instruments
- Suitable for fluid medium which does not clog port or corrode 316 SS

Abbreviations
LM - Lower mount
SS - Stainless steel

Stock items shown in blue print.

Type 332.34

The type 332.34 is an industrial type gauge suitable for corrosive environments where the fluid medium will not clog the connection or corrode 316 SS material. Solid front, blow-out back case design meets safety requirements of ASME B40.100.



Standard Features

Size:	4½"	Pointer:	Black aluminum, adjustable knife-edge
Case:	Black Pocan®	Movement:	Stainless steel
Ring:	Black Pocan®	Accuracy:	±0.25% of span (ASME B40.1 Grade 3A) 0/30" Hg to 600 psi and 2,000 psi to 20,000 psi; ±0.5% of span (ASME B40.1 Grade 2A) 600>2,000 psi
Wetted Parts:	316L SS	Connection:	Lower mount
Window:	Acrylic		
Dial:	White aluminum, with mirrored band		

Type	332.34
Size	4½"
Connection	LM
Conn. Size	1/2" NPT
Press. Scale	PSI
30" Hg	4334711
30"-0-15 psi	4334729
30"-0-30 psi	
30"-0-60 psi	
30"-0-100 psi	
30"-0-160 psi	4334761
30"-0-200 psi	
15 psi	4334770
30 psi	4334788
60 psi	4334796
100 psi	4334800
160 psi	4334818
200 psi	4334826
300 psi	4334834
400 psi	4334842
600 psi	4334851
800 psi	4364398
1,000 psi	50005456
1,500 psi	50058649
2,000 psi	4394506
3,000 psi	4200627
5,000 psi	50008880
10,000 psi	4200792
15,000 psi	
20,000 psi	
Accessory order codes (installed)	
4½" Panel kit	+ PM
Restrictor	+ R

Available Options

- Cleaned for oxygen service
- Instrument glass
- Panel mount kit
- Safety glass
- Special connection

Applications

- Industrial
- Suitable for corrosive environments where the fluid medium will not clog the connection or corrode the wetted part materials.

Abbreviations

LM - Lower mount
SS - Stainless steel

Stock items shown in **blue print**.

Type 332.34DD

WIKA type 332.34DD direct drive test gauge features a direct drive, movementless pressure system. With a shock absorbing Bourdon tube design, these gauges are an effective means for guarding against severe shock and vibration applications that require test gauge accuracy. The 332.34DD is manufactured in a standard black 4½” process gauge style case and comes standard completely equipped with an external zero adjustment and a high 0.25% full scale accuracy.



Standard Features

Size:	4½”	Pointer:	Black aluminum, adjustable knife edge
Case:	Red thermoplastic, solid front	Accuracy:	± 0.25% of span ASME B40.100 Grade 3A ¹⁾
Ring:	Red thermoplastic, solid front	Connection:	Lower mount
Wetted Parts:	X-750 Inconel® / 316 SS	Filter:	Standard, porous filter (25-50 microns)
Window:	Clear acrylic		
Dial:	White aluminum, mirror band with stop pin at 6 o'clock		

Type	332.34DD
Size	4½”
Conn. Size	1/2” NPT
Press. Scale	PSI
-30” to 30 psi	52398498
-30” to 60 psi	52398501
-30” to 150 psi	52398510
-30” to 300 psi	52398528
30 psi	52398544
60 psi	52398552
100 psi	52398561
160 psi	52398579
200 psi	52398587
300 psi	52398609
500 psi	52398617
1,000 psi	52398625
1,500 psi	52398650
2,000 psi	52398684
3,000 psi	52398692
5,000 psi	52398714
10,000 psi	52398722

Available Options

- Cleaned for use in oxygen service
- Special connection
- 4½” panel mount kit (field assembly)
- Lower back mount & connection
- Weather protection NEMA 4 (IP65)

Abbreviations

LM - Lower mount
SS - Stainless steel

¹⁾ Range 0 / 10,000 psi accuracy ± 0.5% of span per ASME B40.100 Grade 2A

Type 332.25 / 312.25

WIKA type 332.25 test gauges have a glass covered hinged ring front with securing screws as standard. The adjustable knife edge pointer is easily accessed under the hinged ring front. Designed for panel mounting, the type 332.25 gauge features 316 SS wetted parts and a one-piece aluminum solid-front safety case design. Well suited for installations in process panel and control applications, type 332.25 gauges meet ASME Grade 3A accuracy standards.



Standard Features

Size:	4½"	Pointer:	Black aluminum, adjustable knife-edge
Case:	Black-painted aluminum	Movement:	Stainless steel
Ring:	Black-painted aluminum	Accuracy:	±0.25% of span (ASME B40.1 Grade 3A) 0/30" Hg to 600 psi and 2,000 psi to 20,000 psi; ±0.5% of span (ASME B40.1 Grade 2A) 600>2,000 psi
Wetted Parts:	316L SS	Connection:	Lower back mount
Window:	Flat instrument glass		
Dial:	White aluminum, with mirrored band		

Type	332.25	
Size	4½"	
Connection	LBM	
Conn. Size	1/4" NPT	1/2" NPT
Press. Scale	PSI	PSI
30" Hg	50675567	50675818
30"-0-15 psi	50663003	50675826
30"-0-30 psi	50675583	50675834
30"-0-60 psi	50675591	50675842
30"-0-100 psi	50675605	50675851
30"-0-160 psi	50675613	50675869
30"-0-200 psi	50675621	50675877
15 psi	50675621	50675885
30 psi	50675648	50675893
60 psi	50675656	50675907
100 psi	50675664	50675915
160 psi	50663011	50675923
200 psi	50663020	50675931
300 psi	50675699	50675940
400 psi	50663038	50675958
600 psi	50663046	50675966
800 psi	50675729	50675974
1,000 psi	50675737	50675982
1,500 psi	50675745	50675991
2,000 psi	50675753	50676008
3,000 psi	50675761	50676016
5,000 psi	50675770	50676024
10,000 psi	50675788	50676032
15,000 psi	50675796	50676041
20,000 psi	50675800	50676059
Accessory order codes (installed)		
Restrictor	+ R	

Available Options

- Copper alloy wetted parts (Type 312.25)
- Cleaned for oxygen service
- Special connections

Applications

- Instrument shops
- Precision panel installations
- Test benches
- Calibration laboratories

Abbreviations

LBM - Lower back mount
SS - Stainless steel

Stock items shown in blue print.

Type 342.11

WIKA type 342.11 precision test gauges are high quality, time-proven instruments designed for applications requiring exceptional precision and high reliability in the measurement of pressure. WIKA precision test gauges feature a Bourdon tube made of Ni-Span C® for all pressure ranges above 0-10 psi. Ni-Span C® has exceptional temperature stability and eliminates the need for an expensive thermal compensator.



Standard Features

Size:	10"	Dial:	White aluminum, with mirrored band
Case:	Grey-painted cast aluminum	Pointer:	Black aluminum, knife-edge
Ring:	Grey-painted cast aluminum	Movement:	Stainless steel
Wetted Parts:	Ni-Span C®	Accuracy:	±0.1% of span ASME B40.100 Grade 4A
Window:	Acrylic, non-reflecting	Connection:	Lower mount

Type	342.11
Size	10"
Connection	LM
Conn. Size	1/4" NPT Female
Press. Scale	PSI
30" Hg	9328750
30"-0-15 psi	9328769
30"-0-30 psi	9328777
30"-0-60 psi	9328785
30"-0-100 psi	9328793
30"-0-150 psi	8988927
30"-0-200 psi	
30"-0-300 psi	
15 psi	9328823
30 psi	9328831
60 psi	9328840
100 psi	9328858
160 psi	9328866
200 psi	9328874
300 psi	9328882
400 psi	9328890
600 psi	9328904
800 psi	8988854
1,000 psi	9328920
1,500 psi	9328939
2,000 psi	9328947
3,000 psi	9328955
5,000 psi	
10,000 psi	
15,000 psi	9328998
20,000 psi	9329005
300" H ₂ O	8590931
400" H ₂ O	
600" H ₂ O	
1,000" H ₂ O	

Available Options

- Cleaned for oxygen service (up to 6,000 psi)
- Special connections including autoclave

Applications

- Pressure gauge for testing, calibration and laboratory measurement
- Fluid medium does not clog port or corrode Ni-Span C® and stainless steel

Notes:

All Type 342.11 gauges are supplied with a NIST Certificate of Calibration.

Abbreviations

LM - Lower mount
SS - Stainless steel

Stock items shown in **blue** print.

Mechanical Pressure > Calibration Equipment > CPH6600

CPH6600

WIKA's CPH6600 is a small, lightweight hand-held calibrator that generates pressures up to 300 psi using a high-performance integral electric pump.

The CPH6600 provides $\pm 0.025\%$ FS accuracy on its internal, isolated pressure sensor. Temperature compensation on its internal sensor ensures accuracy in field applications.

Standard Features

- Integrated electric pump (ranges 30 psi, 150 psi, 300 psi)
- Supplied certified to NIST 0.025% accuracy
- Simultaneous display of pressure, temperature and mA output
- 24V loop power for device under test

Applications

- Calibration of natural gas custody transfer sites
- Field calibration verification on transmitters
- Switch set point setting



MECHANICAL PRESSURE

Type	Range	Part Number
CPH6600	-28" Hg to 30 psi	50846442
	-28" Hg to 150 psi	50846451
	-28" Hg to 300 psi	50846477

Stock items shown in **blue** print.

Mechanical Pressure > Calibration Equipment > CPG 1000

Type CPG 1000

The CPG 1000 digital pressure test gauge takes the concept of an analog test gauge and brings it to a new level. The CPG 1000 combines the accuracy of digital technology with the simplicity of an analog test gauge and achieves performance, ease-of-use and a feature set unmatched in the pressure measurement world.



Standard Features

- Accuracy of (+/-) 0.05% full scale
- Stainless steel case meets NEMA 4, IP65
- Min/max recall
- 18 selectable engineering units,
- 1 user customized unit
- Adjustable tare
-  Class 1, Div. 2, Groups A, B, C, and T6
- Available with optional 24 V external power input
- Rubber boot standard on LM version only

Type	CPG 1000				
Size	4"				
Conn. Size	1/4" NPT				
Configuration	Lower Mount	Lower Back Mount	LM w/ Opt. 24 V Ext. Power	LBM Style w/ Opt. 24 V Ext. Power	Kit w/ Pump, Test Hose & Case
10" W.C.	52189074	N/A	N/A	N/A	N/A
30" W.C.	50577930	50578367	50578529	50578669	N/A
-15-0-15 psi	50577964	50578405	50578553	50579304	50579428
-15-0-30 psi	50577972	50578421	50578561	50579312	50579436
15 psi	50577948	50578383	50578537	50579282	50579401
30 psi	50577956	50578391	50578545	50579291	50579410
100 psi	50577981	50578448	50578570	50579321	50579444
300 psi	50577999	50578456	50578596	50579339	50579452
500 psi	50578003	50578464	50578600	50579347	50579461
1,000 psi	50578014	50578472	50578618	50579355	50579479
2,000 psi	50578022	50578481	50578626	50579363	50579487
3,000 psi	50578341	50578499	50578634	50579371	50579509
5,000 psi	50578359	50578502	50578642	50579380	50579517
10,000 psi	50578375	50578511	50578651	50579398	50579495
15,000 psi	52189058	N/A	N/A	N/A	N/A

	LM	LBM	LM w/24V	LBM w/24V	Kit
15 psia	50579525	50579827	50579860	50579908	N/A
30 psia	50579533	50579835	50579878	50579916	N/A
100 psia	50579541	50579843	50579886	50579924	N/A
300 psia	50579819	50579851	50579894	50579935	N/A

50738631	CPG 1000 Data Log Software
----------	----------------------------

Stock items shown in blue print.

Mechanical Pressure > Calibration Equipment > WICP-L100, WICP-M500, WICP-H10K

Type WICP-L100, WICP-M500, WICP-H10K

WIKA pneumatic and hydraulic test pumps are high performance hand operated pumps that allow the user to generate both pressure and vacuum for precise testing of pressure instrumentation including transmitters, pressure switches and pressure gauges



WICP-L100
Pneumatic Pump Kit



WICP-M500
Pneumatic Pump Kit
(shown with CPG 1000)



WICP-H10K
Pneumatic Pump Kit
(shown with CPG 1000)

Type	RANGE	PART #
WICP-L100	-28" Hg to 100 psi	50578031
WICP-M500	-29" Hg to 600 psi	50578049
WICP-H10K	0 to 10,000 psi	50578057

Accessories	Part Number
Pump Kits <i>Kits include hard sided carrying case</i>	
WICP-L100 Kit - Low Pressure & Vacuum Pump (-28 in. Hg to 100 psi) with one test hose and one 1/8" FNPT port	50578065
WICP-M500 Kit - High Pressure & Vacuum Pump (-29 In Hg to 500 psi) with one test hose and one 1/4" FNPT port	50578284
WICP-H10K Kit - Hydraulic Pump (0 to 10,000 psi) with one test hose and one 1/4" FNPT port	50578073
Fittings and Adapters for Pumps	
Adapter 1/4 F BSP to 1/8 F NPT	50578081
Adapter 1/4 F NPT to 1/4 M BSP	50578090
Adapter 1/4 M NPT to 1/4 F BSP	50578103
Adapter 1/4 M NPT to 1/4 M NPT (Union)	50578111
Connector 1/4 M NPT to quick connect for high pressure hydraulic hose	50578120
Tee, Street, SS, 1/4 F NPT x 1/4 F NPT x 1/4 M NPT	50578138
Adapter 1/8 F NPT to 1/4 F NPT (Union)	50578146
Adapter 1/8 M NPT to 1/4 M BSP	50578154
Adapter 1/8 M NPT to 1/4 M NPT	50578162
Connector 1/8 M NPT to 1/8 quick connect tubing (nylon)	50578171
Hose, high pressure with quick connect fittings for WICP-H10K	6060100
PAK100 Accessory Kit for WICP-L100 includes carrying case, test hose and fittings	1010054
PAK500 Accessory Kit for WICP-M500 includes carrying case, test hose and fittings	1010055
PAK10K Accessory Kit for WICP-H10K includes carrying case, test hose and fittings	1010056

Stock items shown in blue print.



CALIBRATION EQUIPMENT

NOTES:

MECHANICAL PRESSURE

Diaphragm Seals

Diaphragm seals, also referred to as chemical seals, are used to isolate pressure gauges, switches and transmitters from clogging and/or corrosive media. Standard diaphragm seal bodies and diaphragms are made of stainless steel; however, a variety of materials from carbon steel to Hastelloy® C-276 are available to meet the demands of most applications. WIKA diaphragm seals can operate in pressure applications from 10" H₂O to 15,000 psi and media temperature between -130°F and 752°F.

Examples of Typical Diaphragm Seal Applications

- The media is **corrosive** and may damage a sensitive element such as a Bourdon tube gauge, pressure switch or transmitter diaphragm.
- The **temperature** of the media may be too high for a standard gauge, switch or transmitter to operate properly.
- The media is **highly viscous** or tends to **crystallize**, or **polymerize** and may clog the pressure port of a gauge, switch or transmitter.
- The media is **non-homogenous** or contains **suspended matter** such as wood pulp which may clog the pressure port of a gauge, switch or transmitter.
- **Remote reading** is required. A diaphragm seal with a capillary line will allow remote installation of a pressure instrument.
- The **sanitary cleanliness level** is critical. A flush mounted or InLine Seal sanitary type diaphragm seal avoids dead space and cavities.
- The media is **toxic or hazardous** and may pollute the environment. A suitably designed diaphragm seal will provide additional protection, i.e. all-welded designs.
- The application requires **high overpressure protection**. A diaphragm seal with a contoured diaphragm bed can be configured to provide overpressure protection and protection to the instrument, exact temperature data are mandatory.

WIKA diaphragm seal systems are an excellent value and offer savings by:

- Meeting fugitive emission requirements
- Extending the service life of the pressure instrument
- Reducing the cost of installation
- Reducing or eliminating maintenance costs

Operating Principle

The drawing below illustrates the operating principle of a diaphragm seal assembly. A pressure measurement instrument such as a conventional pressure gauge or electronic pressure transmitter is either mounted directly to the diaphragm seal or attached to the seal by means of a capillary or cooling element.

A diaphragm within the diaphragm seal separates the gauge/transmitter from the process medium. Any part of the diaphragm seal (i.e., diaphragm, lower housing, gaskets) which will be exposed to the process medium is selected from materials resistant to pressure, temperature and possible chemical attack by the process medium.

The diaphragm seal is also filled with a transmitting fluid or system fill fluid. Any pressure applied by the process medium to the seal diaphragm is hydraulically transmitted to the pressure element of the gauge/switch/transmitter thus generating a pressure reading.

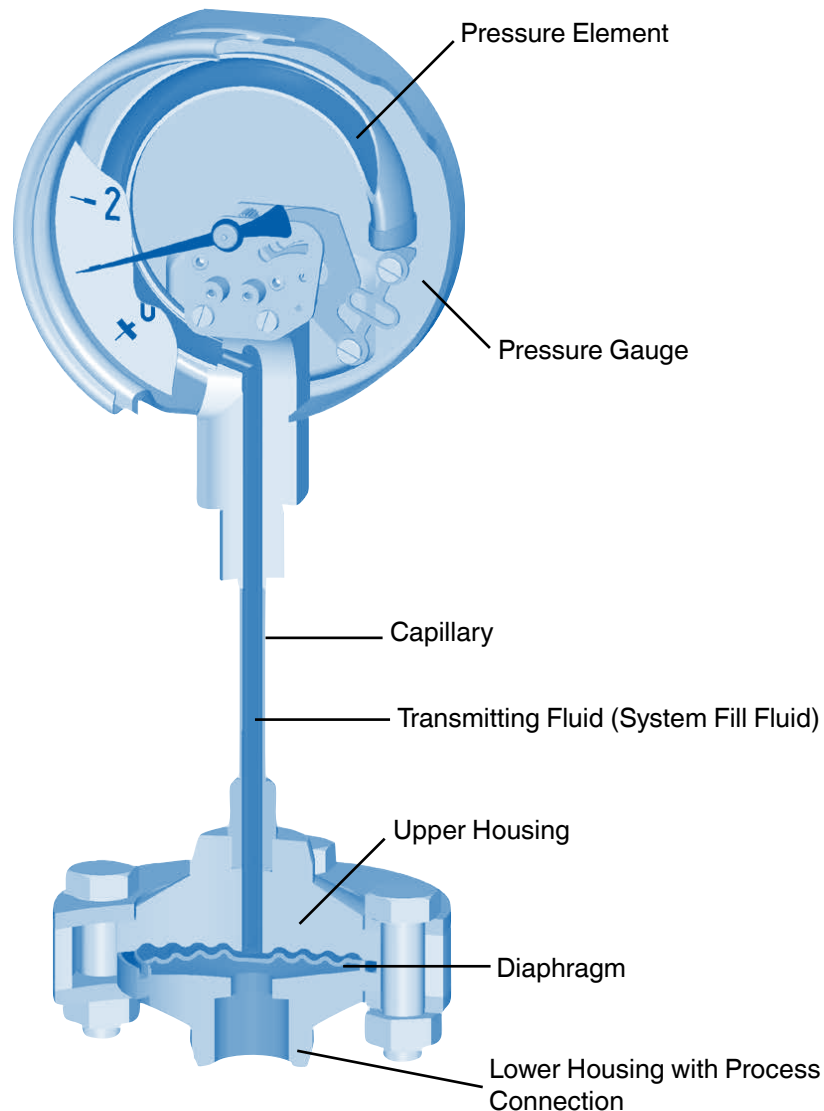

Selection Guidelines

When selecting a diaphragm seal assembly, the following details must be taken into consideration to ensure a safe and satisfactory operation. For specific technical assistance regarding temperature effects, volumetric compatibility, etc., contact WIKA Customer Care or send a completed diaphragm seal specification sheet to the factory for analysis.

- | | |
|-------------------------------|----------------------------------|
| 1. Process composition | 6. System fill fluid |
| 2. Temperature | 7. Mounting position |
| 3. Pressure range | 8. Response time |
| 4. Pressure instrument | 9. Seal and gauge matches |
| 5. Process connection | |

1. Process composition

Since the diaphragm and lower housing of the diaphragm seal will be exposed to the process medium, it is critical to select materials for these components which will be compatible with this medium. Tables are available to assist in the selection of these materials (see Pressure Gauge Section); however, the customer is the ultimate source for specifying suitable materials. **WIKA cannot guarantee suitability.** For information, see numerous reference guides such as corrosion table reference books. This should also be taken into consideration, if the pressure fluid is very thick, solidifies or is full of solids.

2. Temperature

Each diaphragm seal measurement system (diaphragm seal, pressure instrument, and cooling element or capillary, if applicable) is filled with an amount of fill fluid at an ambient temperature of about 70°F. This temperature is referred to as the system fill temperature. The fill fluid will expand or contract according to temperature changes. This in turn causes the pressure in the sensing element to rise or fall, thus **adding zero shifting effects to the instrument output.** To reduce this effect, the temperatures of the process and the environment should be specified when selecting a diaphragm seal system (see Diaphragm Seal Specification Sheet). Special advanced calibration techniques can be used to ensure the best possible accuracy. At temperatures above 300°F, a cooling element or capillary is suggested to protect the pressure instrument.

3. Pressure range

The displacement volume on the diaphragm seal required to "drive" each diaphragm seal measurement system (diaphragm seal, pressure instrument and capillary, if applicable) must be greater than the displacement volume needed to move the pressure sensing element. **Normally, the lower the pressure range, the larger the diaphragm will need to be to "drive" the system.** Conversely, for higher pressure ranges, smaller diaphragms are sufficient. Pressure transmitters also follow the general rule of the lower the pressure, the larger the diaphragm required.

4. Pressure instrument

As mentioned above (Item 3 - Pressure range), the diaphragm seal must supply sufficient displacement volume to enable the pressure instrument to reach full scale. As a general rule, smaller size gauges are better suited to low pressure applications since less displacement volume is required on the part of the diaphragm seal to drive the pressure instrument.

5. Process connection

The process connection is specified by the customer. Most process connections are threaded, flanged or clamped; however, additional connections are available. Teflon® coating and lining is only available in flanged connections, since tapered NPT threads strip off the Teflon® during installation. However, solid Teflon® threaded connections are available with NPT threads.

6. System fill fluid

WIKA offers a wide range of system filling fluids allowing temperatures from -130°F to 752°F. Chemical compatibility of the system fill fluid with the process fluid must be carefully considered in the event of a leak. In food processing applications a nontoxic fluid should be selected. Special fill fluids are also available for oxidizing media such as oxygen and chlorine.

Selection Guidelines (continued)

7. Mounting position

Mounting position is important for diaphragm seal systems which include a capillary. The level difference between the diaphragm seal and the pressure instrument causes a hydrostatic pressure to act on the sensing element:

- a. For gauges mounted above the level of the diaphragm seal, the pointer on the dial of the gauge will be lower than the zero point.
- b. For gauges mounted below the level of the diaphragm seal, the pointer on the dial of the gauge will be higher than the zero point.

The diaphragm seal system can be calibrated to compensate for the effect caused by the hydrostatic pressure, if the level difference is known in advance (see Diaphragm Seal Specification Sheet for assistance).

8. Response time

Response time, i.e., the time it takes the pressure instrument to indicate 90% of the value of a sudden pressure variation, is especially important for instrument/diaphragm seal assemblies which include a capillary. Response time increases significantly in systems with long capillaries. In applications requiring long capillaries, response times can be reduced by using larger diameter capillary tubing and reducing the viscosity of the system fill fluid. Be advised that increasing the inner diameter of the capillary increases the temperature influence of the measuring system. Consult factory if detailed information is needed.

9. Seal and gauge matches

For measurement ranges under 300 psi, WIKA pressure gauges with removable window rings (e.g. 2XX.54, 2XX.34) are preferred over crimped window rings (e.g. 2XX.53). **All gauges with crimp rings might not be usable due to potential recalibration.** The table below shows the common matches between gauge and diaphragm seal types **recommended by the factory**. Please contact the Diaphragm Seal Department for more information.

Table 4 - Seal and Gauge Combinations		
Gauge Size	Range ¹	Seal Type Number
2½"	≥ 60 psi	990.22 1½"
	≥ 30 psi	990.TA
	≥ 15 psi	990.TB
	≥ 15 psi	990.22 2"
	≥ 15 psi	990.10
	≥ 15 psi	990.12
4" or 4½"	≥ 400 psi	990.22 1½"
	≥ 160 psi	990.TA
	≥ 15 psi	990.TB
	≥ 100 psi	990.22 2"
	≥ 15 psi	990.10
	≥ 15 psi	990.12
6"	N/A	990.22 1½"
	N/A	990.TA or 990.TB
	≥ 600 psi	990.22 2"
	≥ 160 psi	990.10
	≥ 160 psi	990.12

¹ The total span between the lowest and highest measurement points of a pressure gauge.
Includes vacuum and compound ranges.
≥ Indicates greater than or equal to

Type M93X.25

Type M93X.25 sanitary gauge provides a 3/4" Tri-Clamp® process connection with a 2 1/2" stainless steel gauge. This assembly contains an electropolished process connection and meets the criteria set by 3A. The gauge is ideal for applications in the food and beverage, pharmaceutical and biotechnology industries.



Standard Features

- Design:** This all-welded gauge assembly contains an external flush diaphragm on the 3/4" Tri-Clamp® process connection. Each gauge contains a traceable identification number.
- Pressure Rating, Maximum:** 1,500 psi, limited by installation clamp rating
- Suitable Pressure Ranges:** See Selection Guide
- Operating Temperature:** 50°F to 257°F (10°C to 125°C)
- Ambient Temperature:** 50°F to 175°F (10°C to 80°C)

Gauge Features

- Dial Size:** 2 1/2"
- Process Connection:** 3/4" Tri-Clamp®
- Process Wetted Materials:** 316L SS electropolished
- Case Material:** Polished stainless steel with vent plug
- Window:** Polycarbonate
- Dial:** Aluminum, white
- Pointer:** Black aluminum
- Accuracy:** ±2/1/2% ASME B40.1 Grade A
- System Fill Fluids:** Glycerine (non-vacuum ranges)
Mineral oil (vacuum and compound ranges)

Available Options

- Integral cooling element (Tmax 300F°)
- Autoclavable (dry case, polysulfone window only)
- External zero adjust

Notes:

- 1) Glycerine (07) is not available for vacuum & compound pressure measurement ranges. Consult factory for exceptions.
- 2) List options in alphabetical order at the end of the configuration code.
- 3) All product under this model series is provided with calibration protocol, electropolish finish, and material based information report per 2.2 EN10204 as standard.
- 4) Autoclave design requires polysulfone window (LPS) and dry gauge case (M932.25).

Order Code:

M932.25

Field no. 1 2 3 4 5 6 7

*Additional order details _____

M93X.25 Selection Guide	
Field no.	Code
	Pressure Range
	C030 -30 inHg ... 30 psi Compound range
	C060 -30 inHg ... 60 psi Compound range
	C100 -30 inHg ... 100 psi Compound Range
	C160 -30 inHg ... 160 psi Compound Range
	P030 30 psi Gauge pressure range
	P060 60 psi Gauge pressure range
	P100 100 psi Gauge pressure range
	P160 160 psi Gauge pressure range
	P200 200 psi Gauge pressure range
	P300 300 psi Gauge pressure range
	P400 400 psi Gauge pressure range
	P600 600 psi Gauge pressure range
1	XXXX Other - consult factory
	Pressure Units
	PX PSI - Single scale
	PC PSI outside / KG/CM ² inside in red
	PK PSI outside / KPA inside in red
	PB PSI outside / BAR inside in red
2	SP Special scale
	Process Connection
	75 3/4" Tri-Clamp® connector
	10 1" Tri-Clamp® connector
3	XX Other - consult factory
	Wetted Parts Material
	ES Electropolished 316L SS (1.4435) Ra ≤ 20 μin
	HC Hastelloy C276 (2.4819)
4	XX Other - consult factory
	System Fill
	07 KN7 - Glycerine 99.7% USP (1000 cst) - FDA 21 CFR 182.1320 ¹
	59 KN59 - Neobee M20 - FDA 21 CFR 172.856, 174.5
	92 KN92 - Mineral Oil LubePharm (23 cst) - FDA 21 CFR 172.878, 178.3620 (a); USP, EP
	93 KN93 - Silicone Oil DC200 (350 cst food grade) - FDA 21 CFR 173.340
5	XX Other - consult factory
	Window Material
	LPC Polycarbonate
6	LPS Polysulfone ⁴
	Options²
	FGL Glycerine case fill - change model # to M933.25
	XMT Material Certificate 3.1 EN10204 (metal only) ³
	WSS Instrument tag, Stainless steel
	MZA External Zero Adjust
	CEO Integral cooling element (Tmax 300°F)
	XAC Autoclave design, case with 2 weep holes ⁴
7	XNI NIST - Certificate of Calibration

Type M93X.3A

Standard Features

Design: All-welded construction in full compliance with 3A third party standards and meets the most rigorous biopharmaceutical specifications. This assembly has all the advantages of the 23X.50 series mechanical gauge (ASME B40.100 & EN 837-1) and WIKA combines it with a superior designed Tri-Clamp® diaphragm seal.

Process Connection: 1½" to 4" Tri-Clamp®

Ranges: Vacuum, compound and positive pressure up to 1,500 psi (limited by installation clamp rating)

Operating Temp: 25°F to 300°F (-4°C to +149°C)

Gauge Size: 2½" or 4" - lower and back mount

Case Fill: Glycerine (optional)

Dial: White aluminum with black lettering

Accuracy: 2½": ±2/1/2% of span, 4": ±1.0% of span

Case Material: 304 SS electropolished case with vent plug and stainless steel electropolished twist lock bayonet ring

Window: Polycarbonate

Pointer: Black aluminum, adjustable

Serial Number: Engraved in back of case

System Fill: Glycerine, non-vacuum application
mineral oil, vacuum and compound range applications

Gauge Features

- All-welded design
- ≤ 20 Ra electropolished
- Engraved material identification and serial number
- Manufacturer calibration report
- FDA-approved system fill fluids
- Meets 3A sanitary criteria

Available Options

- Autoclavable (dry case with weep holes, polysulfone window only)
- Hastelloy C276 wetted parts"
- Cherry Burrell I-Line, APC connections



M93X.3A Selection Guide

Field no.	Code	
1	Dial Size	
	25	2½" Gauge case
	40	4.0" Gauge case
2	Pressure Range	
	V000	-30 inHg...0 Vacuum
	C030	-30 inHg ... 30 psi Compound Range
	C060	-30 inHg ... 60 psi Compound Range
	C100	-30 inHg ... 100 psi Compound Range
	C160	-30 inHg ... 160 psi Compound Range
	P015	0...15psi Gauge pressure range
	P030	0...30 psi Gauge pressure range
	P060	0...60 psi Gauge pressure range
	P100	0...100 psi Gauge pressure range
	P160	0...160 psi Gauge pressure range
	P200	0...200 psi Gauge pressure range
	P300	0...300 psi Gauge pressure range
P400	0...400 psi Gauge pressure range	
P600	0...600 psi Gauge pressure range	
	XXXX	Other - consult factory
3	Pressure Units	
	PX	PSI - Single scale
	PC	PSI outside / Kg/cm ² inside in red
	PK	PSI outside / KPA inside in red
	PB	PSI outside / BAR inside in red
	SP	Special scale

Type M93X.3A

M93X.3A Selection Guide		
Field no.	Code	
4	Connector Location	
	LM	Lower mount
	BK	Center back mount (2½") or Lower back mount (4.0")
5	Diaphragm Seal Design	
	22	Tri-Clamp®
	57F	Cherry Burrell - I-Line Female
	57M	Cherry Burrell - I-Line Male
	58	APC
XX	Other - consult factory	
6	Process Connection ⁶	
	10	1.0 " connector
	15	1.5 " connector
	20	2.0 " connector
	25	2.5 " connector
	30	3.0 " connector
	40	4.0 " connector
7	Wetted Parts Material	
	ES	Electropolished 316L SS (1.4435) Ra ≤ 20 µin
	MO	Monel 400 (2.4360)
	HC	Hastelloy C276 (2.4819)
	XX	Other - consult factory
8	System Fill	
	07	KN7 - Glycerine 99.7% USP (1000cSt) ¹ FDA 21 CFR 182.1320
	59	KN59 - Neobee M20 FDA 21 CFR 172.856, 174.5
	92	KN92 - MINERAL OIL Lubepharm (23cSt) FDA 21 CFR 172.878, 178.3620(a): USP, EP
	93	KN93 - DC200 SILICONE OIL (350cSt Food Grade) FDA 21 CFR 173.340
	XX	Other - consult factory

M93X.3A Selection Guide		
Field no.	Code	
9	Window Material	
	LPC	Polycarbonate
	LPS	Polysulfone
10	Options ²	
	FGL	Glycerine case fill - change model # to M933.3A
	XEP	Wetted parts electro-polished w/ certificate ⁴
	XMT	Material Certificate 3.1 EN10204 (metal only) ⁴
	WSS	Instrument TAG, stainless steel
	RS6	Restrictor, SS 0.6 orifice
	RS3	Restrictor, SS 0.3 orifice
	CE1	Integral Cooling Element Tmax 300°F
	CE2	2" Cooling element ³
	CE4	4" Cooling Element - (Tmax +500°F)
	XAC	Autoclave design, case with 2 weep holes ⁵
	XNI	NIST Certificate of Calibration per 3.1 EN10204
	XXX	Other - consult factory

Notes:

- 1) Glycerine (07) is not available for vacuum & compound pressure measurement ranges. Consult factory for exceptions.
- 2) List options in alphabetical order at the end of the configuration code.
- 3) Cooling elements are welded to the diaphragm seal
- 4) All product under this model series is provided with calibration protocol, electropolish finish, and material based information report as standard. Documentation per 2.2 EN10204
- 5) Autoclave design requires polysulfone window (LPS) and dry gauge case (M932.3A).
- 6) Size limitation for Cherry Burrell and APC both available in 1.5" and 2".

Order Code:

M932.3A

Field no. 1 2 3 4 5 6 7 8 9 10

*Additional order details _____

For datasheets and additional information, please visit www.wika.com or call 1-888-945-2872.

Diaphragm Seals > Assembled Seals > M932.2C

Type M932.2C

Type M932.2C sanitary gauge assembly provides a 3/4" Tri-Clamp® process connection welded to a 1 1/2" or 2" stainless steel gauge. This assembly meets the criteria set by 3A and is ideal for applications in the food and beverage, pharmaceutical and biotechnology industries.



Standard Features

- Pressure Rating, Maximum:** 1,500 psi, limited by installation clamp rating
- Suitable Pressure Ranges:** See selection guide
- Operating Temperature:** 50°F to 257°F (10°C to 125°C)
- Ambient Temperature:** 50°F to 140°F (10°C to 60°C)

Gauge Features

- Gauge Size:** 1 1/2" or 2"
- Process Connection:** 3/4" Tri-Clamp®
- Process Wetted Materials:** 316L SS electropolished
- Case Material:** Stainless steel
- Window:** 1.5" acrylic, 2.0" flat glass
- Dial:** Aluminum, white
- Pointer:** Black aluminum
- Accuracy:** ±3/2/3% of span
- System Fill Fluid:** Glycerine (non-vacuum ranges only); mineral oil, food grade silicone oil and NEOBEE® M20 (positive pressure, vacuum and compound ranges)
- Additional Options:** Hastelloy C276 wetted parts

Type M932.2C

M932.2C Selection Guide		
Field no.	Code	
1	Dial Size	
	15	1.5" Gauge case
	20	2" Gauge case
2	Pressure Range	
	C030	-30 inHg ... 30 psi Compound range
	C060	-30 inHg ... 60 psi Compound range
	C100	-30 inHg ... 100 psi Compound Range
	C160	-30 inHg ... 160 psi Compound Range
	P030	30 psi Gauge pressure range
	P060	60 psi Gauge pressure range
	P100	100 psi Gauge pressure range
	P160	160 psi Gauge pressure range
	P200	200 psi Gauge pressure range
	P300	300 psi Gauge pressure range
	P400	400 psi Gauge pressure range
	P600	600 psi Gauge pressure range
	XXXX	Other - consult factory
3	Pressure Units	
	PX	psi - Single scale
	PC	psi outside / KG/CM ² inside in red
	PK	psi outside / KPA inside in red
	PB	psi outside / BAR inside in red
	SP	Special scale
4	Connector Location	
	LM	Lower mount
	BK	Center back mount

M932.2C Selection Guide		
Field no.	Code	
5	Process Connection	
	75	3/4" Tri-Clamp® connector
6	Wetted Parts Material	
	ES	Electropolished 316L SS (1.4435) Ra ≤ 20 µin
	HC	Hastelloy C276 (2.4819)
	XX	Other - consult factory
7	System Fill	
	07	KN7 - Glycerine 99.7% USP (1000 cst) - FDA 21 CFR 182.1320 ¹
	59	KN59 - Neobee M20 - FDA 21 CFR 172.856, 174.5
	92	KN92 - Mineral Oil LubePharm (23 cst) - FDA 21 CFR 172.878, 178.3620 (a): USP, EP
	93	KN93 - Silicone Oil DC200 (350 cst food grade) - FDA 21 CFR 173.340
XX	Other - consult factory	
8	Window Material	
	LPM	Acrylic - 1.5" dial standard
	LIG	Window glass - 2.0" dial standard
9	Options²	
	XEP	Wetted parts electro-polished w/ certificate
	XMT	Material Certificate 3.1 EN10204 (metal only) ³
	WNI	NIST - Certificate of Calibration
	WSS	Instrument tag, Stainless steel

Notes:

- Glycerine (07) is not available for vacuum & compound pressure measurement ranges. Consult factory for exceptions.
- List options in alphabetical order at the end of the configuration code.

Order Code:

M932.2C

Field no. 1 2 3 4 5 6 7 8 9

*Additional order details _____

Diaphragm Seals > Assembled Seals > M93X.D1

Type M93X.D1

Type M93X.D1 all-welded systems are a drop-in retrofit for existing gauges. This assembly eliminates all potential leak paths and has a tamper-resistant construction. The all-welded system is ideal for installations where tightly controlled fugitive emissions and safety are a concern. The M93X.D1 is well-suited for applications in the chemical, petrochemical and process industries.



Standard Features

Design: This all-welded gauge assembly is constructed using WIKA gauge type number 23X.34 and diaphragm seal type number 990.34. The diaphragm is recessed within the all-welded seal body. The pressure gauge is back-welded to the seal upper housing to eliminate another potential leak path. The threaded seal fill port has been removed to ensure a tamper resistant design. Additional process wetted materials, process connections, system fill fluids and accessories are available to meet the rigorous demands of most applications.

Pressure Rating, Maximum: 1,500 psi and 5,000 psi

Suitable Pressure Ranges: See selection Guide

Operating Temperature: 0 to 300°F (-18°C to 149°C)

Ambient Temperature: -40°F to 150°F (-40°C to 66°C)

Gauge Features

Dial Size: 4½" process gauge

Process Connection: ½" NPT male or female

Process Wetted Materials: 316L SS

Case Material: Fiberglass reinforced thermoplastic

Window: Acrylic

Dial: Aluminum, white

Pointer: Black aluminum

Accuracy: ±0.5% of span

System Fill Fluid: Silicone oil, DC200-10cst.

Available Options

- High temperature (up to 752°F) configurations
- Severe pressure pulsation protection
- Other system fill fluids
- Additional process connections
- Laminated safety glass window
- Stainless steel gauges (i.e. 23X.54)

Notes: (See next page)

- 1) Plugs are not supplied with flushing ports as standard.
- 2) Diaphragm material should match the lower housing material. Please contact the factory for exceptions.
- 3) Glycerine (07) is not available for vacuum & compound pressure measurement ranges. Consult factory for exceptions.
- 4) List options in alphabetical order at the end of the configuration code.
- 5) Cooling element are only offered with 316L stainless steel upper housings.
- 6) If lower is Monel 400, upper must be selected as (M3) Monel M30C

Type M93X.D1

M93X.D1 Selection Guide	
Field no.	Code
	Pressure Range
	V000 -30inHg...0 Vacuum
	C015 -30inHg ... 15 psi Compound Range
	C030 -30inHg ... 30 psi Compound Range
	C060 -30inHg ... 60 psi Compound Range
	C100 -30inHg ... 100 psi Compound Range
	C160 -30inHg ... 160 psi Compound Range
	P015 15 psi Gauge pressure range
	P030 30 psi Gauge pressure range
	P060 60 psi Gauge pressure range
	P100 100 psi Gauge pressure range
	P160 160 psi Gauge pressure range
	P200 200 psi Gauge pressure range
	P300 300 psi Gauge pressure range
	P400 400 psi Gauge pressure range
	P600 600 psi Gauge pressure range
	P800 800 psi Gauge pressure range
	P10C 1000 psi Gauge pressure range
	P15C 1500 psi Gauge pressure range
	P20C 2000 psi Gauge pressure range
	P30C 3000 psi Gauge pressure range
1	P50C 5000 psi Gauge pressure range
	Pressure Units
	PX PSI - Single scale
	PC PSI outside / KG/CM ² inside in red
	PK PSI outside / KPA inside in red
	PB PSI outside / BAR inside in red
2	SP Special scale
	Connector Location
	LM Lower mount
3	BK Lower back mount
	Process Connection
	N2F 1/4" NPT female
	N4F 1/2" NPT female
	N6F 3/4 NPT female
	N8F 1" NPT female
	N4 1/2" NPT male
	N6 3/4" NPT male
	N8 1" NPT male
4	XX Other - consult factory
	Upper Housing Material
	SS Stainless steel 316L (1.4435)
	M3 Monel M30C ⁶
5	XX Other - consult factory

M93X.D1 Selection Guide	
Field no.	Code
	Lower Housing Material
	SS Stainless steel 316L (1.4435)
	HC Hastelloy C276 (2.4819)
	MO Monel 400 (2.4360)
	IN Inconel 600 (2.4816)
	IC Incoloy 825 (2.4858)
	CA Carpenter 20 (2.4660)
	DP Duplex 2205 (1.4462)
	NI Nickel 200 (2.4066)
	S4 Stainless steel 304L (1.4304)
6	XX Other - consult factory
	Flushing Connection Lower Housing¹
	-0 Without
	-1 1 X 1/8" NPT
	-2 1 X 1/4" NPT
	-3 2 x 1/8" NPT
7	-4 2 x 1/4" NPT
	Diaphragm Material²
	SS Stainless steel 316L (1.4435)
	HB Hastelloy B3 (2.4600)
	HC Hastelloy C276 (2.4819)
	MO Monel 400 (2.4360)
	IN Inconel 600 (2.4816)
	IC Incoloy 825 (2.4858)
	NI Nickel 200 (2.4066)
	CA Carpenter 20 (2.4660)
	DP Duplex 2205 (1.4462)
	S4 Stainless steel 304L (1.4304)
8	XX Other - consult factory
	System Fill
	68 KN68 - Silicone DC200-10 cst
	02 KN2 - Silicone DC200-50 cst
	32 KN32 - Silicone DC704
	21 KN21 - Halocarbon 6.3
	07 KN7 - Glycerine 99.7% USP (1000 cst) ³
	92 KN92 - Mineral Oil Lubepharm (23 cst)
9	XX Other - consult factory
	Options⁴
	FGL Glycerine case fill - change model # to M933.D1
	FS1 Silicone 1000 cst case fill - change model # to M933.D1
	LSG Laminated safety glass window
	XMT Material Certificate 3.1 EN10204 (metal only)
	XNC Wetted parts NACE (MR0175/MR0103 Year 2009) compliant
	WSS Instrument tag, Stainless steel
	RS3 Restrictor, SS, 0.3 mm orifice (Super-restrictor)
	PDP Drag pointer, red (standard)
	CE4 4" Cooling element ⁵
	CE8 8" Cooling element ⁵
10	PLG Provided with flushing port plug(s) - 1/8" & 1/4" NPT

Order Code:

M932.D1

Field no. 1 2 3 4 5 6 7 8 9 10

*Additional order details _____

Diaphragm Seals > Threaded Seals > 990.TA

Type 990.TA

When an application is not well-suited for a gauge alone, due to clogging or corrosive material, the WIKA 990.TA is ideal. This mini-seal is economical and features a one-piece, tamper-resistant construction with an upper and lower housing, eliminating the need for a gasket. The 990.TA is used in a variety of industries.



Standard Features

Design: The diaphragm is welded together with the lower and upper housing, generating a leak-free construction. The diaphragm is located between the upper and lower housing. A flushing port can be added to the lower housing to clean the diaphragm cavity.

Pressure Rating, Maximum: 2,500 psi

Suitable Pressure Span, Minimum:

Gauge (Range):

2½", ≥ 30 psi

4" or 4½", ≥ 160 psi

Pressure Transmitters: ≥ 60 psi

Operating Temperature: -40°F to 500°F (-40°C to 260°C)

Available Options

- Other materials
- Additional process connections
- 5,000 psi design

Notes:

- 1) Axial weld-in connections and cooling elements are only available on 316L stainless steel upper housings.
- 2) Titanium is not offered with any other materials other than itself for this seal model.
- 3) Plugs are not supplied with flushing ports as standard.
- 4) List options in alphabetical order at the end of the configuration code.
- 5) Cooling elements are welded to the diaphragm seal.
- 6) Diaphragm material should match the lower housing material. Please contact the factory for exceptions.

990.TA Selection Guide		
Field no.	Code	
1	Instrument Connection	
	N4F	1/2" NPT female
	N2F	1/4" NPT female
	CPL	Capillary (Axial weld-in) connection ¹
2	Process Connection	
	N2F	1/4" NPT female
	N4F	1/2" NPT female
	N2	1/4" NPT male
	N4	1/2" NPT male

990.TA Selection Guide			
Field no.	Code		
3	Upper Housing Material		
	SS	Stainless steel 316L (1.4435)	
	TI	Titanium Grade 2 (3.7035) ²	
	MO	Monel 400 (2.4360)	
	HC	Hastelloy C276 (2.4819)	
	CA	Carpenter 20 (2.4660)	
	XX	Other - consult factory	
4	Lower Housing Material		
	SS	Stainless steel 316L (1.4435)	
	HC	Hastelloy C276 (2.4819)	
	MO	Monel 400 (2.4360)	
	IC	Incoloy 825 (2.4858)	
	TI	Titanium Grade 2 (3.7035) ²	
	CA	Carpenter 20 (2.4660)	
5	Flushing Connection Lower Housing ³		
	-0	Without	
	-1	1 X 1/8" NPT	
6	Diaphragm Material ⁶		
	SS	Stainless steel 316L (1.4435)	
7	Pressure Rating @ 250°F		
	2500	2500 psi MWP	
	5000	5000 psi MWP	
	Options ⁴		
	XMT	Material Certificate 3.1 EN10204 (metal only)	
	XNC	Wetted parts NACE (MR0175/MR0103 Year 2009) compliant	
	CE4	4" Cooling element ^{1,5}	
	8	Provided flushing port plugs - 1/8" & 1/4" NPT male	
		PLG	

Order Code:

L990.TA

Field no. 1 2 3 4 5 6 7 8

*Additional order details _____

Diaphragm Seals > Threaded Seals > 990.TB

Type 990.TB

The WIKA type 990.TB large mini-seal is used for low pressure applications to protect the installed instrument from clogging due to viscous, contaminated or solidified process medium. This seal also allows for an exotic material interface with the process to protect the instrument from a corrosive application.

Standard Features

Design: The diaphragm is welded together with the lower and upper housing, generating a leak-free construction. The diaphragm is located between the upper and lower housing. A flushing port can be added to the lower housing to clean the diaphragm cavity.

Pressure Rating, Maximum: 2,500 psi

Suitable Pressure Span, Minimum:

Gauge (Range):

2½", ≥ 15 psi

4" or 4½", ≥ 15 psi

Pressure Transmitters: ≥ 15 psi

Operating Temperature: -130°F to 752°F (-90°C to 400°C)

Available Options

- Other materials
- Additional process connections
- Capillary tubing



990.TB Selection Guide		
Field no.	Code	
1	Instrument Connection	
	N4F	1/2" NPT female
	N2F	1/4" NPT female
	CPL	Capillary (Axial weld-in) connection ¹
2	Process Connection	
	N2F	1/4" NPT female
	N4F	1/2" NPT female
	N6F	3/4" NPT female
	N8F	1" NPT female
	N2	1/4" NPT male
	N4	1/2" NPT male
	N6	3/4" NPT male
	N8	1" NPT male

Order Code:

990.TB

Field no. 1 2 3 4 5 6 7 8

*Additional order details _____

990.TB Selection Guide			
Field no.	Code		
3	Upper Housing Material		
	SS	Stainless steel 316L (1.4435)	
	MO	Monel 400 (2.4360)	
4	Lower Housing Material		
	SS	Stainless steel 316L (1.4435)	
	HC	Hastelloy C276 (2.4819)	
	MO	Monel 400 (2.4360)	
	IC	Incoloy 825 (2.4858)	
	CA	Carpenter 20 (2.4660)	
	DP	Duplex 2205 (1.4462)	
5	Flushing Connection Lower Housing ³		
	-0	Without	
	-1	1 X 1/8" NPT	
6	Diaphragm Material ⁵		
	SS	Stainless steel 316L (1.4435)	
7	Pressure Rating @ 250°F		
	2500	2500 psi MWP	
	Options ³		
	XMT	Material Certificate 3.1 EN10204 (metal only)	
	XNC	Wetted parts NACE (MR0175/MR0103 Year 2009) compliant	
	CE4	4" Cooling element ^{1,4}	
	CE8	8" Cooling element ^{1,4}	
	8	Provided flushing port plug(s) - 1/8" & 1/4" NPT male	

Notes

- 1) Axial weld-in connections and cooling elements are only available on 316L stainless steel upper housings.
- 2) Plugs are not supplied with flushing ports as standard.
- 3) List options in alphabetical order at the end of the configuration code.
- 4) Cooling elements are welded to the diaphragm seal.
- 5) Diaphragm material should match the lower housing material. Please contact the factory for exceptions.

Diaphragm Seals > Threaded Seals > 990.10

Type 990.10

WIKA's type 990.10 standard threaded seal configuration is constructed of an upper and lower housing with a welded diaphragm. The design of this multi-purpose seal enables it to be used on a variety of applications.



Standard Features

Design: The diaphragm is welded to the upper housing which allows the replacement of the lower housing without jeopardizing the integrity of the system fill fluid and installed instrument. The upper and lower housing are bolted together and sealed by use of an O-ring. Process wetted components can be manufactured with solid metallic and nonmetallic materials.

Pressure Rating, Maximum: up to 3,625 psi

Suitable Pressure Span, Minimum:

Gauge (Range):

2½", ≥ 15 psi

4" or 4½", ≥ 15 psi

Pressure Transmitters: ≥ 15 psi

Operating Temperature: -130°F to 752°F (-90°C to 400°C)

Available Options

- Other materials
- Additional process connections
- Cooling element
- Capillary tubing

Notes: (see next page)

- 1) Axial weld-in connections and cooling elements are only available on 316L stainless steel upper housings.
- 2) Titanium upper housings and diaphragms are only offered together for this seal model.
- 3) Maximum working pressure is 200 psi at 200°F (8 bolts @ N/C). Only 1/4" and 1/2" NPT female connections are available.
- 4) Plugs are not supplied with flushing ports as standard.
- 5) For use with silver plated metal gasket (AS) and 8 bolt configuration (3625) for process media temperatures up to 752°F.
- 6) Teflon coating (PF) is not intended for full corrosion protection. It is applied as a non-stick coating only.
- 7) Viton® (VI) gaskets are standard for 316L (SS) and carbon steel (CS) wetted parts. Teflon® (TF) gaskets are standard for all other wetted parts configurations.
- 8) Only the PTFE lower housing (TF) does not require a gasket. See note 7 for all other lower housings.
- 9) List options in alphabetical order at the end of the configuration code.
- 10) Cooling elements are welded to the diaphragm seal.

Type 990.10

990.10 Selection Guide			
Field no.	Code		
1	Instrument Connection		
	N4F	1/2" NPT female	
	N2F	1/4" NPT female	
	CPL	Capillary (Axial weld-in) connection ¹	
	2	Process Connection	
		N2F	1/4" NPT female
		N4F	1/2" NPT female
		N6F	3/4" NPT female
		N8F	1" NPT female
		N2	1/4" NPT male
N4		1/2" NPT male	
N6		3/4" NPT male	
N8		1" NPT male	
XX		Other - consult factory	
3	Upper Housing Material		
	CS	Carbon steel 1018, Nickel plated	
	SS	Stainless steel 316L (1.4435)	
	TI	Titanium Grade 2 (3.7035) ²	
	MO	Monel 400 (2.4360)	
	HC	Hastelloy C276 (2.4819)	
	DP	Duplex 2205 (1.4462)	
	XX	Other - consult factory	
	4	Lower Housing Material	
		CS	Carbon steel 1018, Nickel plated
SS		Stainless steel 316L (1.4435)	
HB3		Hastelloy B3 (2.4600)	
HC		Hastelloy C276 (2.4819)	
MO		Monel 400 (2.4360)	
IN		Inconel 600 (2.4816)	
IC		Incoloy 825 (2.4858)	
TI		Titanium Grade 2 (3.7035)	
TF		Solid virgin PTFE ³	
CA	Carpenter 20 (2.4660)		
5	Flushing Connection Lower Housing ⁴		
	-0	Without	
	-1	1 X 1/8" NPT	
	-2	1 X 1/4" NPT	
	-3	2 X 1/8" NPT	
	-4	2 X 1/4" NPT	
	-5	1 X 1/2" NPT	
	-6	2 X 1/2" NPT	

990.10 Selection Guide			
Field no.	Code		
6	Clamp & Support Material (including nuts and bolts)		
	CS	Retainer flange and bolts in galvanized steel max. 500°F	
	SS	Retainer flange and bolts in stainless steel max. 500°F	
	HS	Retainer flange stainless steel and high tensile bolts - max. 752°F ⁵	
	7	Diaphragm Material	
		SS	Stainless steel 316L (1.4435)
		HB	Hastelloy B2 (2.4617)
		HC	Hastelloy C276 (2.4819)
		MO	Monel 400 (2.4360)
		IN	Inconel 600 (2.4816)
IC		Incoloy 825 (2.4858)	
TA		Tantalum	
NI		Nickel 200 (2.4066)	
TI		Titanium Grade 2 (3.7035) ²	
8	Gasket Material ⁷		
	BN	BUNA-N (NBR) max. 212°F	
	VI	Viton® (FPM) max. 400°F	
	TF	Teflon® (PTFE) max. 500°F	
	AS	Metal Seal Form C, Inconel / Silver plated - max 752°F	
	NA	None - for PTFE lower ⁸	
	XX	Other - consult factory	
	9	Pressure Rating @ 250°F	
		200	200 PSI MWP for plastic lower (8 bolt design)
		1500	1500 PSI MWP (standard 4 bolts) (not for high temp bolts and ring)
10	Options ⁹		
	XMT	Material Certificate 3.1 EN10204 (metal only)	
	XNC	Wetted parts NACE (MR0175/MR0103 Year 2009) compliant	
	CE4	4" Cooling element ^{1,10}	
	CE8	8" Cooling element ^{1,10}	
	PLG	Provided with flushing port plug(s) - 1/8" & 1/4"	
	PLG	Provided with flushing plug(s) - 1/2" NPT male	

DIAPHRAGM SEALS

*Additional order details _____

Order Code:

990.10 **X**

Field no. 1 2 3 4 5 6 7 8 9 10

For datasheets and additional information, please visit www.wika.com or call 1-888-945-2872.

Diaphragm Seals > Threaded Seals > 990.TC

Type 990.TC

WIKA's type 990.TC threaded seal is constructed of an upper and lower housing, two O-rings and a diaphragm. Due to the clamped diaphragm design, if excessive wear occurs to the configuration, the diaphragm can be replaced as the pressure instrument remains intact.



Standard Features

Design: The diaphragm is clamped between the upper and lower housing. This design allows for the installation of metallic and nonmetallic diaphragms. The upper and lower housing and diaphragm are bolted together and sealed by use of two O-rings. Process wetted components can be manufactured with solid metallic and nonmetallic materials.

Pressure Rating, Maximum: up to 2,500 psi

Suitable Pressure Span, Minimum:

Gauge (Range):

2½", ≥ 15 psi

4 or 4½", ≥ 15 psi

Pressure Transmitters: ≥ 15 psi

Operating Temperature: -130°F to 500°F (-90°C to 260°C)

Available Options

- Other materials
- 4" cooling element

Notes: (see next page)

- 1) Axial weld-in connections are only available on 316L stainless steel upper housings.
- 2) Plugs are not supplied with flushing ports as standard.
- 3) Teflon® spray coating (PF) is not intended for full corrosion protection. It is applied as a non-stick coating only.
- 4) Viton® (VI) gaskets are standard for 316L (SS) and carbon steel (CS) wetted parts. Teflon® (TF) gaskets are standard for all other wetted parts configurations.
- 5) List options in alphabetical order at the end of the configuration code.
- 6) Viton® diaphragm requires 2500 psi (MWP) 8-bolt configuration.

Type 990.TC

990.TC Selection Guide	
Field no.	Code
	Instrument Connection
	N4F 1/2" NPT female
	N2F 1/4" NPT female
1	CPL Capillary (Axial weld-in) connection ¹
	Process Connection
	N2F 1/4" NPT female
	N4F 1/2" NPT female
	N6F 3/4" NPT female
	N8F 1" NPT female
	N2 1/4" NPT male
	N4 1/2" NPT male
	N6 3/4" NPT male
	N8 1" NPT male
2	XX Other - consult factory
	Upper Housing Material
	CS Carbon steel 1018, Nickel plated
3	SS Stainless steel 316L (1.4435)
	Lower Housing Material
	CS Carbon steel 1018, Nickel plated
	SS Stainless steel 316L (1.4435)
	HB3 Hastelloy B3 (2.4600)
	HC Hastelloy C276 (2.4819)
	MO Monel 400 (2.4360)
	IN Inconel 600 (2.4816)
	IC Incoloy 825 (2.4858)
	TI Titanium Grade 2 (3.7035)
	CA Carpenter 20 (2.4660)
	DP Duplex 2205 (1.4462)
	NI Nickel 200 (2.4066)
	S4 Stainless steel 304L (1.4304)
4	XX Other - consult factory
	Flushing Connection Lower Housing²
	-0 Without
	-1 1 X 1/8" NPT
	-2 1 X 1/4" NPT
	-3 2 X 1/8" NPT
5	-4 2 X 1/4" NPT
	Clamp & Support Material (including nuts and bolts)
	CS Retainer flange and bolts in galvanized steel max. 500°F
6	SS Retainer flange and bolts in stainless steel max. 500°F

990.TC Selection Guide	
Field no.	Code
	Diaphragm Material
	SS Stainless steel 316L (1.4435)
	HB Hastelloy B3 (2.4600)
	HC Hastelloy C276 (2.4819)
	MO Monel 400 (2.4360)
	IN Inconel 600 (2.4816)
	IC Incoloy 825 (2.4858)
	TA Tantalum
	NI Nickel 200 (2.4066)
	TI Titanium Grade 2 (3.7035)
	CA Carpenter 20 (2.4660)
	SW Stainless steel (316L) with virgin PTFE-foil (Tmax 300°F)
	PF Stainless steel (316L) with Teflon®-spray-coating ³
	DP Duplex 2205 (1.4462)
	S4 Stainless steel 304L (1.4304)
	VI Viton® ⁶
7	XX Other - consult factory
	Gasket Material⁴
	BN BUNA-N (NBR) max. 212°F
	VI Viton® (FPM) max. 400°F
8	TF Teflon® (PTFE) max. 500°F
	Pressure Rating @ 250°F
	1500 1500 psi MWP (standard 4 bolts)
9	2500 2500 psi (8 bolt design)
	Options⁵
	XMT Material Certificate 3.1 EN10204 (metal only)
	XNC Wetted parts NACE (MR0175/MR0103 Year 2009) compliant
10	PLG Provided with flushing port plugs -1/8" & 1/4" NPT male

Order Code:

990.TC **X**

Field no. 1 2 3 4 5 6 7 8 9 10

*Additional order details _____

Diaphragm Seals > Threaded Seals > 990.40

Type 990.40

WIKA's type 990.40 large displacement volume threaded seal is constructed of an upper and lower housing with a welded diaphragm. This design allows for a variety of usable materials to be assembled to meet the requirements of specific applications. The large diameter diaphragm is excellent for use on low pressure applications and with switches that contain a large displacement volume to activate.



Standard Features

Pressure Rating, Maximum: 1,500 psi

Suitable Pressure Span, Minimum:

Gauge (Range):

2½", ≥ 15 psi

4 or 4½", ≥ 15 psi

Pressure Transmitters: ≥ 100 in H₂O

Differential Transmitters (Span): ≥ 10" H₂O

Operating Temperature: -130°F to 752°F (-90°C to 400°C)

Available Options

- Other materials
- Additional process connections
- Capillary tubing

Notes: (see next page)

- 1) Axial weld-in connections and cooling elements are only available on 316L stainless steel upper housings.
- 2) Titanium upper housings and diaphragms are only offered together for this seal model.
- 3) Plugs are not supplied with flushing ports as standard.
- 4) For use with silver plated metal gasket (AS) for process media temperatures up to 752°F.
- 5) Teflon® spray coating (PF) is not intended for full corrosion protection. It is applied as a non-stick coating only.
- 6) Viton® (VI) gaskets are standard for 316L (SS) and carbon steel (CS) wetted parts. Teflon® (TF) gaskets are standard for all other wetted parts configurations.
- 7) List options in alphabetical order at the end of the configuration code.
- 8) Cooling elements are welded to the diaphragm seal.
- 9) Threaded instrument connections on this model come with M6 fill ports as standard.

Type 990.40

990.40 Selection Guide	
Field no.	Code
	Instrument Connection
	N4F 1/2" NPT female ⁹
	N2F 1/4" NPT female ⁹
1	CPL Capillary (Axial weld-in) connection ¹
	Process Connection
	N2F 1/4" NPT female
	N4F 1/2" NPT female
	N6F 3/4" NPT female
	N8F 1" NPT female
	N4 1/2" NPT male
	N6 3/4" NPT male
2	N8 1" NPT male
	Upper Housing Material
	CS Carbon steel 1018, Nickel plated
	SS Stainless steel 316L (1.4435)
3	TI Titanium Grade 2 (3.7035) ²
	Lower Housing Material
	CS Carbon steel 1018, Nickel plated
	SS Stainless steel 316L (1.4435)
	HB3 Hastelloy B3 (2.4600)
	HC Hastelloy C276 (2.4819)
	MO Monel 400 (2.4360)
	IN Inconel 600 (2.4816)
	IC Incoloy 825 (2.4858)
	TI Titanium Grade 2 (3.7035)
	CA Carpenter 20 (2.4660)
4	DP Duplex 2205 (1.4462))
	Flushing Connection Lower Housing³
	-0 Without
	-2 1 X 1/4" NPT
	-4 2 x 1/4" NPT
	-5 1 X 1/2" NPT
5	-6 2 X 1/2" NPT
	Bolting Material
	CS Bolts in galvanized steel max. 500°F
	SS Bolts in stainless steel max. 500°F
6	HS High tensile stainless steel bolts - max. 752°F ⁴

990.40 Selection Guide	
Field no.	Code
	Diaphragm Material
	SS Stainless steel 316L (1.4435)
	HB Hastelloy B2 (2.4617)
	HC Hastelloy C276 (2.4819)
	MO Monel 400 (2.4360)
	IN Inconel 600 (2.4816)
	IC Incoloy 825 (2.4858)
	TA Tantalum
	NI Nickel 200 (2.4066)
	TI Titanium Grade 2 (3.7035) ²
	CA Carpenter 20 (2.4660)
	PF Stainless steel (316L) with Teflon®-spray-coating ⁵
	AU Stainless steel (316L) with Gold Lining 10 µin
7	DP Duplex 2205 (1.4462)
	Gasket Material⁶
	VI Viton® (FPM) max. 400°F
	TF Teflon® (PTFE) max. 500°F
8	AS Metal Seal Form C, Inconel / Silver plated - max 752°F
	Pressure Rating @ 250°F
	200 200 psi MWP for 4.9" diaphragm size
9	1500 1500 psi MWP for 2.9" & 3.5" diaphragm size
	Diaphragm Diameter
	2.9 2.9" (72mm) special size (MWP = 1500PSI)
	3.5 3.5" (89mm) standard size (MWP = 1500PSI)
10	4.9 4.9" (124mm) special size (MWP = 200PSI)
	Options⁷
	XMT Material Certificate 3.1 EN10204 (metal only)
	XNC Wetted parts NACE (MR0175/MR0103 Year 2009) compliant
	CE4 4" Cooling element ^{1,8}
	CE8 8" Cooling element ^{1,8}
11	PLG Provided with flushing port plug(s) - 1/8" & 1/4" NPT male

*Additional order details _____

Order Code:

L990.40 **X**

Field no. 1 2 3 4 5 6 7 8 9 10 11

For datasheets and additional information, please visit www.wika.com or call 1-888-945-2872.

Diaphragm Seals > Threaded Seals > 990.34

Type 990.34

The type 990.34 high pressure seal is installed on pressure gauges or pressure transmitters. This seal protects the installed instrument from clogging due to viscous, contaminated or solidified process media. This all-welded design is used in controlled fugitive emissions applications.



9000/15,000 psi



1,500/5,000 psi

Standard Features

Design: Diaphragm, lower and upper housing are welded together generating a leak-free construction. The diaphragm is located between the upper and lower housing. A flushing port can be added to the lower housing to clean the diaphragm cavity.

Pressure Rating, Maximum:

1,500 psi, 5,000 psi, 9,000 psi

Suitable Pressure Span, Minimum:

Gauge, Range (with 9,000/15,000 psi version):

2½", ≥ 30 psi

4½", ≥ 160 psi

Gauge, Range (with 1,500/5,000 psi version):

2½", ≥ 15 psi

4 & 4½", ≥ 15 psi

Operating Temperature:

-130°F to 752°F (-90°C to 400°C)

Available Options

- Other materials
- Additional process connections
- Capillary tubing

Type 990.34

990.34 Selection Guide			
Field no.	Code		
1	Instrument Connection		
	N4F	1/2" NPT female ⁶	
	N2F	1/4" NPT female ⁶	
	CPL	Capillary (Axial weld-in) connection ¹	
2	Process Connection		
	N2F	1/4" NPT female	
	N4F	1/2" NPT female	
	N6F	3/4" NPT female	
	N8F	1" NPT female	
	N2	1/4" NPT male	
	N4	1/2" NPT male	
	N6	3/4" NPT male	
3	Upper Housing Material		
	SS	Stainless steel 316L (1.4435)	
	TI	Titanium Grade 2 (3.7035) ²	
	M3	Monel M30C ⁸	
	HC	Hastelloy C276 (2.4819)	
4	Lower Housing Material		
	SS	Stainless steel 316L (1.4435)	
	HB3	Hastelloy B3 (2.4600)	
	HC	Hastelloy C276 (2.4819)	
	MO	Monel 400 (2.4360)	
	IN	Inconel 600 (2.4816)	
	IC	Incoloy 825 (2.4858)	
	TI	Titanium Grade 2 (3.7035) ²	
	CA	Carpenter 20 (2.4660)	
	DP	Duplex 2205 (1.4462)	
	5	Flushing Connection Lower Housing ³	
		-0	Without
-1		1 X 1/8" NPT	
-2		1 X 1/4" NPT	
-3		2 x 1/8" NPT	
-4	2 x 1/4" NPT		

990.34 Selection Guide		
Field no.	Code	
6	Diaphragm Material ⁷	
	SS	Stainless steel 316L (1.4435)
	HB	Hastelloy B2 (2.4617)
	HC	Hastelloy C276 (2.4819)
	MO	Monel 400 (2.4360)
	IN	Inconel 600 (2.4816)
	IC	Incoloy 825 (2.4858)
	TI	Titanium Grade 2 (3.7035) ²
	CA	Carpenter 20 (2.4660)
	DP	Duplex 2205 (1.4462)
7	Pressure Rating @ 250°F	
	1500	1500 psi MWP
	5000	5000 psi MWP
8	Options ⁴	
	150C	15000 psi MWP
8	XMT	Material Certificate 3.1 EN10204 (metal only)
	XNC	Wetted parts NACE (MR0175/MR0103 Year 2009) compliant
	CE4	4" Cooling element ^{1,5}
	CE8	8" Cooling element ^{1,5}
8	PLG	Provided with flushing plug(s) - 1/8" & 1/4" NPT male

Notes:

- 1) Axial weld-in connections and cooling elements are only available on 316L stainless steel upper housings.
- 2) Titanium is not offered with any other materials other than itself for this seal model.
- 3) Plugs are not supplied with flushing ports as standard.
- 4) List options in alphabetical order at the end of the configuration code.
- 5) Cooling elements are welded to the diaphragm seal.
- 6) Threaded instrument connections on this model come with M6 fill ports as standard.
- 7) Diaphragm material should match the lower housing material. Please contact the factory for exceptions.
- 8) If lower is Monel 400, upper must be selected as (M3) Monel M30C.

Order Code:

990.34 X

Field no. 1 2 3 4 5 6 7 8

*Additional order details _____

Diaphragm Seals > Threaded Seals > 990.36

Type 990.36

WIKA type 990.36 high-pressure button seal is used on pressure gauges or pressure transmitters. The flush diaphragm protects the installed instrument from clogging due to viscous and solidified process media. This flush design eliminates material hardening within an internal cavity, which may occur in a standard threaded seal.



Standard Features

Design: The diaphragm is located flush on the end of the male threaded process connection. The seal body is constructed of similar material as the diaphragm. This all-welded design eliminates all potential seal leak paths.

Pressure Rating, Maximum: 9,000 psi

Suitable Pressure Span, Minimum:

Gauge Mechanical, Range:

1" NPT-male process connection:

2½", ≥ 160 psi

4 & 4½", ≥ 1,000 psi

2" NPT- male process connection:

2½", ≥ 15 psi

4 & 4½", ≥ 30 psi

Gauge & Absolute Switch or Transmitter, Span:

¾" NPT-male process connection ≥ 160 psi

1" NPT-male process connection ≥ 160 psi

2" NPT-male process connection ≥ 15 psi

Differential Switch or Transmitter, Span: N/A

Operating Temperature: -130°F to 752°F (-90°C to 400°C)

Type 990.36

990.36 Selection Guide		
Field no.	Code	
1	Instrument Connection	
	N4F	1/2" NPT female
	N2F	1/4" NPT female
	CPL	Capillary (Axial weld-in) connection ¹
	Process Connection	
2	N4	1/2" NPT male consult factor
	N6	3/4" NPT male consult factor
	N8	1" NPT male
	N12	1.5" NPT male
	N16	2" NPT male
3	Housing Material	
	SS	Stainless steel 316L (1.4435)
	HC	Hastelloy C276 (2.4819)
	MO	Monel 400 (2.4360)
	TI	Titanium Grade 2 (3.7035)
	DP	Duplex 2205 (1.4462)
4	Diaphragm Material ²	
	SS	Stainless steel 316L (1.4435)
	HC	Hastelloy C276 (2.4819)
	MO	Monel 400 (2.4360)
	TI	Titanium Grade 2 (3.7035)
	DP	Duplex 2205 (1.4462)
5	Options ³	
	XMT	Material Certificate 3.1 EN10204 (metal only)
	XNC	Wetted parts NACE (MR0175/MR0103 Year 2009) compliant

Notes:

- 1) Axial weld-in connections and cooling elements are only available on 316L stainless steel upper housings.
- 2) Diaphragm material should match the housing material. Please contact the factory for exceptions.
- 3) List options in alphabetical order at the end of the configuration code.
- 4) Cooling elements are welded to the diaphragm seal.

Order Code:

990.36 **X**

Field no. 1 2 3 4 5

*Additional order details _____

Type 990.12

Type 990.12, WIKA's standard flanged seal configuration, has an upper and lower housing with a welded diaphragm. This construction allows for a variety of usable materials and process connection sizes to be assembled to meet the requirements of specific applications.



Standard Features

Design: The diaphragm is welded to the upper housing which allows the replacement of the lower housing without jeopardizing the integrity of the system fill fluid and installed instrument. The upper and lower housing are bolted together and sealed by use of an O-ring. Process wetted components can be manufactured with solid metallic, metallic lined and nonmetallic lined materials. Additional sealing faces and flange standards are available.

Pressure Rating, Maximum: flange rating per ASME B16.5

Suitable Pressure Span, Minimum:

Gauge (Range):

2½", ≥ 15 psi

4 or 4½", ≥ 15 psi

Pressure Transmitters: ≥ 15 psi

Operating Temperature: -130°F to 752°F (-90°C to 400°C)

Available Options

- Other materials
- Additional process connections, EN 1092-1, JIS
- Cooling element
- Capillary tubing

Notes: (see next page)

- 1) Axial weld-in connections and cooling elements are only available on 316L stainless steel upper housings.
- 2) ANSI/ASME B16.5 class 900 and 1500 flanges share dimensions for NPS ≤ 2.0-in.
- 3) Customer to outline the exact ANSI/ASME B16.5 flange pressure class required for any RTJ sealing face request.
- 4) Titanium upper housings and diaphragms are only offered together for this seal model.
- 5) These lower housing materials are only offered in smooth finish facings (RFSF) and are not offered with flushing ports.
- 6) Plugs are not supplied with flushing ports as standard.
- 7) For use with silver plated metal gasket (AS) for process media temperatures up to 752°F.
- 8) Teflon® spray coating (PF) is not intended for full corrosion protection. It is applied as a non-stick coating only.
- 9) Viton® (VI) gaskets are standard for 316L (SS) and carbon steel (CS) wetted parts. Teflon® (TF) gaskets are standard for all other wetted parts configurations.
- 10) Only the PTFE-lined lower housing (SW) will not require a gasket. See note 9 for all other lower housings.
- 11) List options in alphabetical order at the end of the configuration code.
- 12) Cooling elements are welded to the diaphragm seal.

Type 990.12

990.12 Selection Guide		
Field no.	Code	
1	Instrument Connection	
	N4F	1/2" NPT female
	N2F	1/4" NPT female
	CPL	Capillary (Axial weld-in) connection ¹
	Process Connection according to ASME B16.5	
	50	1/2" pipe
	75	3/4" pipe
	10	1" pipe
	15	1.5" pipe
	20	2" pipe
2	Flange Rating	
	-150	150#
	-300	300#
	-600	600#
3	-15X	900#/1500# ²
	Flange Faces	
4	R	RF = Raised Face (125-250 RMS)
	J	RTJ = Ring Type Joint ³
	F	FF = Flat Face
	S	RFSF = Raised Face Smooth Finish
	Upper Housing Material	
5	CS	Carbon steel 1018, Nickel plated
	SS	Stainless steel 316L (1.4435)
	TI	Titanium Grade 2 (3.7035) ⁴
	MO	Monel 400 (2.4360)
	HC	Hastelloy C276 (2.4819)
	DP	Duplex 2205 (1.4462)
	Lower Housing Material	
	CS	Carbon steel 1018, Nickel plated
	SS	Stainless steel 316L (1.4435)
	HB3	Hastelloy B3 (2.4600)
	HC	Hastelloy C276 (2.4819)
	MO	Monel 400 (2.4360)
	IN	Inconel 600 (2.4816)
	IC	Incoloy 825 (2.4858)
	TA	Stainless steel with tantalum lining ⁵
	NI	Nickel 200 (2.4066)
	TI	Titanium Grade 2 (3.7035)
CA	Carpenter 20 (2.4660)	
SW	Stainless steel with Virgin PTFE Lining ⁵	
PF	Stainless steel with Teflon spray coating	
DP	Duplex 2205 (1.4462)	
6	S4	Stainless steel 304L (1.4304)

990.12 Selection Guide			
Field no.	Code		
7	Flushing Connection Lower Housing ⁶		
	-0	Without	
	-1	1 x 1/8" NPT	
	-2	1 x 1/4" NPT	
	-3	2 x 1/8" NPT	
	-4	2 x 1/4" NPT	
	-5	1 x 1/2" NPT	
7	-6	2 x 1/2" NPT	
	Clamp & Support Material (including nuts and bolts)		
8	CS	Retainer flange and bolts in galvanized steel max. 500°F	
	SS	Retainer flange and bolts in stainless steel max. 500°F	
	HS	Retainer flange stainless steel and high tensile bolts - max. 752°F ⁷	
Diaphragm Material			
9	SS	Stainless steel 316L (1.4435)	
	HB	Hastelloy B2 (2.4617)	
	HC	Hastelloy C276 (2.4819)	
	MO	Monel 400 (2.4360)	
	IN	Inconel 600 (2.4816)	
	IC	Incoloy 825 (2.4858)	
	TA	Tantalum	
	NI	Nickel 200 (2.4066)	
	TI	Titanium Grade 2 (3.7035) ⁴	
	CA	Carpenter 20 (2.4660)	
	SW	Stainless steel (316L) with virgin PTFE-foil	
	PF	Stainless steel (316L) with Teflon [®] -spray-coating ⁸	
	AU	Stainless steel (316L) with Gold Lining 10 µin	
	DP	Duplex 2205 (1.4462)	
	S4	Stainless steel 304L (1.4304)	
	Gasket Material ⁹		
	9	BN	BUNA-N (NBR) max. 212°F
VI		Viton [®] (FPM) max. 400°F	
TF		Teflon [®] (PTFE) max. 500°F	
AS		Metal Seal Form C, Inconel / Silver plated - max 752°F	
NA		None ¹⁰	
Options ¹¹			
10	XMT	Material Certificate 3.1 EN10204 (metal only)	
	XNC	Wetted parts NACE (MR0175/MR0103 Year 2009) compliant	
	CE4	4" Cooling element ^{1,12}	
	CE8	8" Cooling element ^{1,12}	
	11	PLG	Provided with flushing port plug(s) -1/8" & 1/4" NPT male

DIAPHRAGM SEALS

*Additional order details _____

Order Code:

990.12 **X**

Field no. 1 2 3 4 5 6 7 8 9 10 11

For datasheets and additional information, please visit www.wika.com or call 1-888-945-2872.

Diaphragm Seals > Flanged Seals > 990.FA

Type 990.FA

The type 990.FA flanged seal is constructed of an upper and lower housing, two O-rings and a diaphragm. The clamped diaphragm provides a method of replacing only the diaphragm when damage or excessive wear occurs.



Standard Features

Pressure Rating, Maximum: 2,500 psi or maximum flange rating per ASME B16.5

Suitable Pressure Span, Minimum:

Gauge (Range):

2½", ≥ 15 psi

4 or 4½", ≥ 15 psi

Pressure Transmitters: ≥ 15 psi

Operating Temperature: -130°F to 500°F (-90°C to 260°C)

Available Options

- Other materials
- Additional process connections, EN 1092-1, JIS
- Capillary tubing

Notes: (see next page)

- 1) Axial weld-in connections and cooling elements are only available on 316L stainless steel upper housings.
- 2) Customer to outline the exact ANSI/ASME B16.5 flange pressure class required for any RTJ sealing face request.
- 3) These lower housing materials are only offered in smooth finish facings (RFSF) and are not offered with flushing ports.
- 4) Plugs are not supplied with flushing ports as standard.
- 5) Teflon® spray coating (PF) is not intended for full corrosion protection. It is applied as a non-stick coating only.
- 6) Viton® (VI) gaskets are standard for 316L (SS) and carbon steel (CS) wetted parts. Teflon® (TF) gaskets are standard for all other wetted parts configurations.
- 7) List options in alphabetical order at the end of the configuration code.
- 8) Cooling elements are welded to the diaphragm seal.

Type 990.FA

990.FA Selection Guide	
Field no.	Code
	Instrument Connection
	N4F 1/2" NPT female
	N2F 1/4" NPT female
1	CPL Capillary (Axial weld-in) connection ¹
	Process Connection according to ASME B16.5
	50 1/2" pipe
	75 3/4" pipe
	10 1" pipe
	15 1.5" pipe
2	20 2" pipe
	Flange Rating
	-150 150#
	-300 300#
3	-600 600#
	Flange Faces
	R RF = Raised Face (125-250RMS)
	J RTJ = Ring Type Joint ²
	F FF = Flat Face
4	S RFSF = Raised Face Smooth Finish
	Upper Housing Material
	CS Carbon steel 1018, Nickel plated
	SS Stainless steel 316L (1.4435)
	TI Titanium Grade 2 (3.7035)
	MO Monel 400 (2.4360)
	HC Hastelloy C276 (2.4819)
5	DP Duplex 2205 (1.4462)
	Lower Housing Material
	CS Carbon steel 1018, Nickel plated
	SS Stainless steel 316L (1.4435)
	HB Hastelloy B2 (2.4600)
	HC Hastelloy C276 (2.4819)
	MO Monel 400 (2.4360)
	IN Inconel 600 (2.4816)
	IC Incoloy 825 (2.4858)
	TA Stainless steel with tantalum lining ³
	NI Nickel 200 (2.4066)
	TI Titanium Grade 2 (3.7035)
	CA Carpenter 20 (2.4660)
	SW Stainless steel with virgin PTFE Lining ³
	PF Stainless steel with Teflon PFA spray coating ⁵
	DP Duplex 2205 (1.4462)
6	S4 Stainless steel 304L (1.4304)

990.FA Selection Guide	
Field no.	Code
	Flushing Connection Lower Housing⁴
	-0 Without
	-1 1 X 1/8" NPT
	-2 1 X 1/4" NPT
	-3 2 x 1/8" NPT
	-4 2 x 1/4" NPT
	-5 1 X 1/2" NPT
7	-6 2 X 1/2" NPT
	Clamp & Support Material (including nuts and bolts)
	CS Retainer flange and bolts in galvanized steel max. 500°F
8	SS Retainer flange and bolts in stainless steel max. 500°F
	Diaphragm Material
	SS Stainless steel 316L (1.4435)
	HB Hastelloy B2 (2.4617)
	HC Hastelloy C276 (2.4819)
	MO Monel 400 (2.4360)
	IN Inconel 600 (2.4816)
	IC Incoloy 825 (2.4858)
	TA Tantalum
	NI Nickel 200 (2.4066)
	TI Titanium Grade 2 (3.7035)
	CA Carpenter 20 (2.4660)
	SW Stainless steel (316L) with virgin PTFE-foil
	PF Stainless steel (316L) with Teflon®PFA-spray-coating ⁵
	AU Stainless steel (316L) with Gold Lining 10 µin
	DP Duplex 2205 (1.4462)
9	S4 Stainless steel 304L (1.4304)
	Gasket Material⁶
	BN BUNA-N (NBR) max. 212°F
	VI Viton® (FPM) max. 400°F
10	TF Teflon® (PTFE) max. 500°F
	Options⁷
	XMT Material Certificate 3.1 EN10204 (metal only)
	XNC Wetted parts NACE (MR0175/MR0103 Year 2009) compliant
	CE4 4" Cooling element ^{1,8}
11	PLG Provided with flushing port plug(s) -1/8" & 1/4" NPT male

DIAPHRAGM SEALS

*Additional order details _____

Order Code:

990.FA X

Field no. 1 2 3 4 5 6 7 8 9 10 11

For datasheets and additional information, please visit www.wika.com or call 1-888-945-2872.

Diaphragm Seals > Flanged Seals > 990.FC

Type 990.FC

Type 990.FC, 1" and 1½", flanged seal configuration is comprised of a two-piece lower housing (flange and insert). The flange on this seal contains through holes for mounting with the end user's flange. The construction of this seal allows for numerous materials to be used for the process-wetted components.



Standard Features

Design: The insert on the flanged connection is bolted to the flange and upper housing and sealed with an O-ring. The flange and upper housing can be constructed of plated carbon steel or stainless steel. All process wetted components can be comprised of numerous materials, solid or lined.

Process Rating, Maximum: flange rating per ASME B16.5

Suitable Pressure Span, Minimum:

Gauge (Range):

2½", ≥ 15 psi

4 or 4½", ≥ 15 psi

Pressure Transmitters: ≥ 15 psi

Operating Temperature: -130°F to 752°F (-90°C to 400°C)

Available Options

- Other materials
- Cooling element
- Capillary tubing

Notes: (see next page)

- 1) Axial weld-in connections and cooling elements are only available on 316L stainless steel upper housings.
- 2) Titanium upper housings and diaphragms are only offered together for this seal model.
- 3) These lower housing materials are only offered in smooth finish facings (RFSF) and are not offered with flushing ports.
- 4) Plugs are not supplied with flushing ports as standard.
- 5) Teflon® spray coating (PF) is not intended for full corrosion protection. It is applied as a non-stick coating only.
- 6) Viton® (VI) gaskets are standard for 316L (SS) and carbon steel (CS) wetted parts. Teflon® (TF) gaskets are standard for all other wetted parts configurations.
- 7) Only the design PTFE-lined lower housing (SW) does not require a gasket. See note 7 for all other lower housings.
- 8) List options in alphabetical order at the end of the configuration code.
- 9) Cooling elements are welded to the diaphragm seal.

Type 990.FC

990.FC Selection Guide	
Field no.	Code
	Instrument Connection
	N4F 1/2" NPT female
	N2F 1/4" NPT female
1	CPL Capillary (Axial weld-in) connection ¹
	Process Connection according to ASME B16.5
	10 1" pipe
2	15 1.5" pipe
	Flange Rating
	-150 150#
	-300 300#
3	-600 600#
	Flange Faces
	R RF = Raised Face (125-250RMS)
4	S RFSF = Raised Face Smooth Finish
	Upper Housing Material
	CS Carbon steel 1018, Nickel plated
	SS Stainless steel 316L (1.4435)
	TI Titanium Grade 2 (3.7035)
	MO Monel 400 (2.4360)
	HC Hastelloy C276 (2.4819)
5	DP Duplex 2205 (1.4462)
	Lower Housing Material
	CS Carbon steel 1018, Nickel plated
	SS Stainless steel 316L (1.4435)
	HB Hastelloy B2 (2.4617)
	HC Hastelloy C276 (2.4819)
	MO Monel 400 (2.4360)
	IN Inconel 600 (2.4816)
	IC Incoloy 825 (2.4858)
	TA Tantalum lined ³
	NI Nickel 200 (2.4066)
	TI Titanium Grade 2 (3.7035)
	CA Carpenter 20 (2.4660)
	SW Stainless steel with virgin PTFE Lining ³
	PF Stainless steel with Teflon spray coating ⁵
	DP Duplex 2205 (1.4462)
6	S4 Stainless steel 304L (1.4304)

990.FC Selection Guide	
Field no.	Code
	Flushing Connection Lower Housing⁴
	-0 Without
	-1 1 X 1/8" NPT
	-2 1 X 1/4" NPT
	-3 2 x 1/8" NPT
7	-4 2 x 1/4" NPT
	Clamp & Support Material (including nuts and bolts)
	CS Retainer flange and bolts in galvanized steel max. 500°F
8	SS Retainer flange and bolts in stainless steel max. 500°F
	Diaphragm Material
	SS Stainless steel 316L (1.4435)
	HB Hastelloy B3 (2.4600)
	HC Hastelloy C276 (2.4819)
	MO Monel 400 (2.4360)
	IN Inconel 600 (2.4816)
	IC Incoloy 825 (2.4858)
	TA Tantalum
	NI Nickel 200 (2.4066)
	TI Titanium Grade 2 (3.7035)
	CA Carpenter 20 (2.4660)
	SW Stainless steel (316L) with virgin PTFE-foil
	PF Stainless steel (316L) with Teflon®-spray-coating ⁵
	AU Stainless steel (316L) with Gold Lining 10 µin
	DP Duplex 2205 (1.4462)
9	S4 Stainless steel 304L (1.4304)
	Gasket Material⁶
	BN BUNA-N (NBR) max. 212°F
	VI Viton® (FPM) max. 400°F
	TF Teflon® (PTFE) max. 500°F
	AS Metal Seal Form C, Inconel / Silver plated - max 752°F
10	NA None
	Options⁷
	XMT Material Certificate 3.1 EN10204 (metal only)
	XNC Wetted parts NACE (MR0175/MR0103 Year 2009) compliant
	CE4 4" Cooling element ^{1,8}
	CE8 8" Cooling element ^{1,9}
11	PLG Provided with flushing port plug(s) -1/8" & 1/4" NPT male

DIAPHRAGM SEALS

*Additional order details _____

Order Code:

990.FC **X**

Field no. 1 2 3 4 5 6 7 8 9 10 11

For datasheets and additional information, please visit www.wika.com or call 1-888-945-2872.

Diaphragm Seals > Flanged Seals > 990.FD

Type 990.FD

The 990.FD is a process industry diaphragm seal used in combination with pressure gauges. The design of this seal consists of an internal clamped diaphragm with a threaded process connection. The 990.FD diaphragm seal is intended for corrosive, contaminated, hot or viscous pressure media.



Standard Features

Pressure Rating, Maximum: flange rating per ASME B16.5

Suitable Pressure Span, Minimum:

Gauge (Range):

2½", ≥ 15 psi

4 or 4½", ≥ 15 psi

Pressure Transmitters: ≥ 15 psi

Operating Temperature: -130°F to 500°F (-90°C to 260°C)

Available Options

- Other materials
- Capillary tubing

Notes: (see next page)

- 1) Axial weld-in connections and cooling elements are only available on 316L stainless steel upper housings.
- 2) These lower housing materials are only offered in smooth finish facings (RFSF) and are not offered with flushing ports.
- 3) Plugs are not supplied with flushing ports as standard.
- 4) Teflon spray coating (PF) is not intended for full corrosion protection. It is applied as a non-stick coating only.
- 5) Viton® (VI) gaskets are standard for 316L (SS) and carbon steel (CS) wetted parts. Teflon® (TF) gaskets are standard for all other wetted parts configurations.
- 6) List options in alphabetical order at the end of the configuration code.
- 7) Cooling elements are welded to the diaphragm seal.

Type 990.FD

990.FD Selection Guide	
Field no.	Code
	Instrument Connection
	N4F 1/2" NPT female
	N2F 1/4" NPT female
1	CPL Capillary (Axial weld-in) connection ¹
	Process Connection according to ASME B16.5
2	10 1" pipe
	15 1.5" pipe
	Flange Rating
	-150 150#
	-300 300#
3	-600 600#
	Flange Faces
	R RF = Raised Face (125-250RMS)
4	S RFSF = Raised Face Smooth Finish
	Upper Housing Material
	CS Carbon steel 1018, Nickel plated
	SS Stainless steel 316L (1.4435)
5	TI Titanium Grade 2 (3.7035)
	Lower Housing Material
	CS Carbon steel 1018, Nickel plated
	SS Stainless steel 316L (1.4435)
	HB3 Hastelloy B3 (2.4600)
	HC Hastelloy C276 (2.4819)
	MO Monel 400 (2.4360)
	IN Inconel 600 (2.4816)
	IC Incoloy 825 (2.4858)
	TA Stainless steel with tantalum lining ²
	NI Nickel 200 (2.4066)
	TI Titanium Grade 2 (3.7035)
	CA Carpenter 20 (2.4660)
	SW Stainless steel with virgin PTFE Lining ²
	PF Stainless steel with Teflon PFA spray coating ⁴
	DP Duplex 2205 (1.4462)
6	S4 Stainless steel 304L (1.4304)

990.FD Selection Guide	
Field no.	Code
	Flushing Connection Lower Housing³
	-0 Without
	-1 1 X 1/8" NPT
	-2 1 X 1/4" NPT
	-3 2 x 1/8" NPT
7	-4 2 x 1/4" NPT
	Clamp & Support Material (including nuts and bolts)
	CS Retainer flange and bolts in galvanized steel max. 500°F
8	SS Retainer flange and bolts in stainless steel max. 500°F
	Diaphragm Material
	SS Stainless steel 316L (1.4435)
	HB Hastelloy B2 (2.4617)
	HC Hastelloy C276 (2.4819)
	MO Monel 400 (2.4360)
	IN Inconel 600 (2.4816)
	IC Incoloy 825 (2.4858)
	TA Tantalum
	NI Nickel 200 (2.4066)
	TI Titanium Grade 2 (3.7035)
	CA Carpenter 20 (2.4660)
	SW Stainless steel (316L) with virgin PTFE-foil
	PF Stainless steel (316L) with Teflon® PFA spray-coating ⁴
	AU Stainless steel (316L) with Gold Lining 10 µin
	DP Duplex 2205 (1.4462)
9	S4 Stainless steel 304L (1.4304)
	Gasket Material⁵
	BN BUNA-N (NBR) max. 212°F
	VI Viton® (FPM) max. 400°F
10	TF Teflon® (PTFE) max. 500°F
	Options⁶
	XMT Material Certificate 3.1 EN10204 (metal only)
	XNC Wetted parts NACE (MR0175/MR0103 Year 2009) compliant
	CE4 4" Cooling element ^{1,7}
11	PLG Provided with flushing port plug(s) - 1/8" & 1/4" NPT male

Order Code:

990.FD X

Field no. 1 2 3 4 5 6 7 8 9 10 11

*Additional order details _____

Diaphragm Seals > Flanged Seals > 990.FB

Type 990.FB

WIKA type 990.FB, all-welded flanged seal configuration is comprised of an upper and lower housing welded together with an internal diaphragm providing a leak-free design. This all-welded design is ideal for applications where emissions to the environment are tightly monitored.



Standard Features

Pressure Rating, Maximum: 1,500 psi or maximum flange rating per ASME B.16.5

Suitable Pressure Span, Minimum:

Gauge (Range):

2½", ≥ 15 psi

4 or 4½", ≥ 15 psi

Pressure Transmitters: ≥ 15 psi

Operating Temperature: -130°F to 752°F (-90°C to 400°C)

Available Options

- Other process connections, EN 1092-1, JIS
- Cooling element
- Capillary tubing

Notes: (see next page)

- 1) Axial weld-in connections and cooling elements are only available on 316L stainless steel upper housings.
- 2) ANSI/ASME B16.5 class 900 and class 1500 flanges share dimensions for NPS ≤ 2.0-in
- 3) Customer to outline the exact ANSI/ASME B16.5 flange pressure class required for any RTJ sealing face request.
- 4) Titanium is not offered with any other materials other than itself for this seal model.
- 5) Plugs are not supplied with flushing ports as standard.
- 6) List options in alphabetical order at the end of the configuration code.
- 7) Cooling elements are welded to the diaphragm seal.
- 8) Diaphragm material should match the lower housing material. Please contact the factory for exceptions.
- 9) If lower is Monel 400, upper must be selected as (M3) Monel M30C.

Type 990.FB

990.FB Selection Guide	
Field no.	Code
	Instrument Connection
	N4F 1/2" NPT female
	N2F 1/4" NPT female
1	CPL Capillary (Axial weld-in) connection ¹
	Process Connection according to ASME B16.5
	50 1/2" pipe
	75 3/4" pipe
	10 1" pipe
	15 1 1/2" pipe
2	20 2" pipe
	Flange Rating
	-150 150#
	-300 300#
	-600 600#
3	-15X 900/1500# ²
	Flange Faces
	R RF = Raised Face (125-250RMS)
	J RTJ = Ring Type Joint ³
4	S RFSF = Raised Face Smooth Finish
	Upper Housing Material
	SS Stainless steel 316L (1.4435)
	TI Titanium grade 2 (3.7035) ⁴
	M3 Monel M30C ⁹
	HC Hastelloy C276 (2.4819)
5	DP Duplex 2205 (1.4462)
	Lower Housing Material
	SS Stainless steel 316L (1.4435)
	HB3 Hastelloy B3 (2.4600)
	HC Hastelloy C276 (2.4819)
	MO Monel 400 (2.4360)
	IN Inconel 600 (2.4816)
	IC Incoloy 825 (2.4858)
	NI Nickel 200 (2.4066)
	TI Titanium Grade 2 (3.7035) ⁴
	CA Carpenter 20 (2.4660)
	DP Duplex 2205 (1.4462)
6	S4 Stainless steel 304L (1.4304)

990.FB Selection Guide	
Field no.	Code
	Flushing Connection Lower Housing⁵
	-0 Without
	-1 1 X 1/8" NPT
	-2 1 X 1/4" NPT
	-3 2 x 1/8" NPT
7	-4 2 x 1/4" NPT
	Diaphragm Material^{2,8}
	SS Stainless steel 316L (1.4435)
	HB Hastelloy B2 (2.4617)
	HC Hastelloy C276 (2.4819)
	MO Monel 400 (2.4360)
	IN Inconel 600 (2.4816)
	IC Incoloy 825 (2.4858)
	NI Nickel 200 (2.4066)
	TI Titanium Grade 2 (3.7035) ⁴
	CA Carpenter 20 (2.4660)
	DP Duplex 2205 (1.4462)
8	S4 Stainless steel 304L (1.4304)
	Options⁶
	XMT Material Certificate 3.1 EN10204 (metal only)
	XNC Wetted parts NACE (MR0175/MR0103 Year 2009) compliant
	CE4 4" Cooling element ^{1,7}
	CE8 8" Cooling element ^{1,7}
9	PLG Provided with flushing port plug(s) - 1/8" & 1/4" NPT male

*Additional order details _____

Order Code:

990.FB **X**

Field no. 1 2 3 4 5 6 7 8 9

Diaphragm Seals > Flanged Seals > 990.26

Type 990.26

Type 990.26 flanged diaphragm seal is a one-piece design. The diaphragm is recessed from the end user's gasket-sealing surface. A variety of process wetted materials are available. This seal is commonly installed on transmitters and pressure gauges.

Standard Features

Design: This seal contains a recessed diaphragm to the gasket-sealing surface. This seal is a one-piece design removing all requirements for internal gaskets and O-rings.

Pressure Rating, Maximum: 725 psi maximum flange rating per ASME B16.5

Suitable Pressure Span, Minimum:

Gauge (Range):

2½", ≥ 15 psi

4 or 4½", ≥ 15 psi

Pressure Transmitters: ≥ 15 psi

Operating Temperature: -130°F to 752°F (-90°C to 400°C)

Available Options

- Cooling element
- Capillary tubing
- Rotatable version (990.FE, 1.0" NPS)

Notes:

- 1) Axial weld-in connections and cooling elements are only available on 316L stainless steel flange housings.
- 2) These lower housing materials are only offered in smooth finish facings (RF) and are not offered with flushing ports.
- 3) All titanium design, only threaded instrument connections available.
- 4) List options in alphabetical order at the end of the configuration code.
- 5) Cooling elements are welded to the diaphragm seal.
- 6) Threaded instrument connections on this model come with M6 fill ports as standard.



990.26 Selection Guide

Field no.	Code	
1	Instrument Connection	
	N4F	1/2" NPT female ⁶
	N2F	1/4" NPT female ⁶
	CPL	Capillary (Axial weld-in) connection ¹
2	Process Connection (according to ASME B16.5)	
	50	1/2" flange
	75	3/4" flange
	10	1" flange
3	Flange Rating	
	-150	150#
	-300	300#
	-600	600#
4	Flange Faces	
	R	RF = Raised Face (125-250 RMS)
	S	RFSF = Raised Face Smooth Finish
	Material of Wetted Parts	
5	SS	Stainless steel 316L (1.4435)
	HB	Hastelloy B2 (2.4617)
	HC	Hastelloy C276 (2.4819)
	MO	Monel 400 (2.4360)
	IN	Inconel 600 (2.4816)
	IC	Incoloy 825 (2.4858)
	TA	Stainless steel with tantalum lining ²
	NI	Nickel 200 (2.4066)
	TI	Titanium Grade 2 (3.7035) ³
	CA	Carpenter 20 (2.4660)
	DP	Duplex 2205 (1.4462)
	S4	Stainless steel 304L (1.4304)
6	Options ⁴	
	XMT	Material Certificate 3.1 EN10204 (metal only)
	XNC	Wetted parts NACE (MR0175/MR0103 Year 2009) compliant
	CE4	4" Cooling element ^{1,5}
CE8	8" Cooling element ^{1,5}	

*Additional order details _____

Order Code:

990.26

X

Field no.

1

2

3

4

5

6

Diaphragm Seals > Flanged Seals > 990.27

Type 990.27

Type 990.27 flanged, flush diaphragm seal is a one-piece design. The diaphragm is flush with the end user's gasket-sealing surface which removes all internal cavities, avoiding clogging and media build-up. A wide variety of process wetted materials are available, such as solid metallic, metal or plastic-lined, and coated. This seal is commonly installed on transmitters and pressure gauges.



Standard Features

Design: This seal contains a diaphragm flush on the gasket-sealing surface.

This seal is a one-piece design removing all requirements for internal gaskets and O-rings. All exotic metal process wetted surfaces either use the patented WIKA metal bonding process or seam welding for diaphragm attachment that protects all welds from exposure to the process media.

316 SS series flange material is standard for WIKA. Additional sealing faces and flange standards are available.

Pressure Rating, Maximum: Maximum flange rating per ASME B16.5

Suitable Pressure, Minimum:

Gauge Mechanical, Range: ≥ 15 psi

Switch or Transmitter, Span: 200" H₂O

Differential Switch or Transmitter, Span: 10" H₂O differential

Operating Temperature: -130°F to 752°F (-90°C to 400°C)

Available Options

- Other materials
- Other process connections, EN 1092-1, JIS
- Capillary tubing

Notes: (see next page)

- 1) Weld-in connections and cooling elements are only available on 316L stainless steel flange housings.
- 2) ANSI/ASME B16.5 class 900 and class 1500 flanges share dimensions for NPS ≤ 2.0 -in
- 3) Customer to outline the exact ANSI/ASME B16.5 flange pressure class required for any RTJ sealing face request.
- 4) These diaphragm material options are only available with raised face smooth finish (RFSF) flange faces.
- 5) Titanium diaphragm available with 316L (SS) flange housing for process media temperature up to 300°F. All titanium design required for higher temperatures.
- 6) Teflon® spray coating (PF) is not intended for full corrosion protection. It is applied as a non-stick coating only.
- 7) List options in alphabetical order at the end of the configuration code.
- 8) Cooling elements are welded to the diaphragm seal.
- 9) Threaded instrument connections on this model come with M6 fill ports as standard.

Type 990.27

DIAPHRAGM SEALS

990.27 Selection Guide	
Field no.	Code
1	Instrument Connection
	N4F 1/2" NPT female ⁹ (Axial)
	N4F-R 1/2" NPT female ⁹ (Radial)
	N2F 1/4" NPT female ⁹ (Axial)
	N2F-R 1/4" NPT female ⁹ (Radial)
	CPL Capillary (Axial weld-in) connection ¹
CPL-R Capillary (Radial weld-in) connection ¹	
2	Process Connection (according to ASME B16.5)
	15 1.5" flange
	20 2" flange
	30 3" flange
	40 4" flange
	5X 5" flange
3	Flange Rating
	-150 150#
	-300 300#
	-600 600#
	-900 900# ²
	-15X 1500# ²
4	Flange Faces
	R RF = Raised Face (125-250RMS)
	J RTJ = Ring Type Joint ³
	F FF = Flat Face
S RFSF = Raised Face Smooth Finish	
5	Flange Housing Material
	SS Stainless steel 316L (1.4435)

990.27 Selection Guide	
Field no.	Code
6	Diaphragm Material
	SS Stainless steel 316L (1.4435)
	HB Hastelloy B3 (2.4600)
	HC Hastelloy C276 (2.4819)
	MO Monel 400 (2.4360)
	IN Inconel 600 (2.4816) ⁴
	IC Incoloy 825 (2.4858) ⁴
	TA Tantalum
	NI Nickel 200 (2.4066) ⁴
	TI Titanium Grade 2 (3.7035) ^{4,5}
	CA Carpenter 20 (2.4660) ⁴
	PF Stainless steel (316L) with Teflon [®] PFA spray-coating ⁶
	AU Stainless steel (316L) with Gold Lining 10 μm ⁴
DP Duplex 2205 (1.4462) ⁴	
7	Options (see note 7)
	XMT Material Certificate 3.1 EN10204 (metal only)
	XNC Wetted parts NACE (MR0175/MR0103 Year 2009) compliant
	CE4 4" Cooling element ^{1,8}
CE8 8" Cooling element ^{1,8}	

Order Code:

*Additional order details _____

990.27 **X**

Field no. 1 2 3 4 5 6 7

For datasheets and additional information, please visit www.wika.com or call 1-888-945-2872.

Diaphragm Seals > Flanged Seals > 990.FR

Type 990.FR

Type 990.FR flanged, flush diaphragm seal is a two-piece design. The diaphragm is flush with the end user's gasket-sealing surface which removes all internal cavities. To avoid clogs and media build-up, a wide variety of process wetted materials are available, such as solid metallic, metal or plastic lined and coated. This seal is commonly installed on transmitters and pressure gauges.



Standard Features

Design: This seal contains a diaphragm flush on the gasket-sealing surface.

This seal is a two-piece design removing all requirements for internal gaskets and O-rings. All exotic metal process wetted surfaces either use the patented WIKA metal bonding process or seaming welding for diaphragm attachment that protects all welds from exposure to the process media. 316 SS series flange material is standard for WIKA. Additional sealing faces and flange standards are available.

Pressure Rating, Maximum: Maximum flange rating per ASME B16.5

Suitable Pressure, Minimum:

Gauge Mechanical, Range: ≥ 15 psi

Switch or Transmitter, Span: 200" H₂O

Differential Switch or Transmitter, Span: 10" H₂O differential

Operating Temperature: -130°F to 752°F (-90°C to 400°C)

Available Options

- Other materials
- Other process connections, EN 1092-1, JIS
- Capillary tubing

Notes: (see next page)

- 1) Axial weld-in connections and cooling elements are only available on 316L stainless steel flange housings.
- 2) ANSI/ASME B16.5 class 900 and class 1500 flanges share dimensions for NPS ≤ 2.0 -in with exception to RTJ faces. Please use code (15X) for any class 900 flange within these conditions.
- 3) Customer to outline the exact ANSI/ASME B16.5 flange pressure class required for any RTJ sealing face request.
- 4) Titanium diaphragm available with 316L stainless steel flange housing for process media temperature up to 300 oF. All titanium design required for higher temperatures.
- 5) These diaphragm material options are only available with raised face smooth finish (RFSF) flange faces.
- 6) Teflon® spray coating (PF) is not intended for full corrosion protection. It is applied as a non-stick coating only.
- 7) List options in alphabetical order at the end of the configuration code.
- 8) Cooling elements are welded to the diaphragm seal.

Diaphragm Seals > Flanged Seals > 990.FR

Type 990.FR

DIAPHRAGM SEALS

990.FR Selection Guide	
Field no.	Code
1	Instrument Connection
	N4F 1/2" NPT female
	N2F 1/4" NPT female
	CPL Capillary (Axial weld-in) connection ¹
Process Connection (according to ASME B16.5)	
2	20 2" flange
	30 3" flange
	40 4" flange
	5X 5" flange
Flange Rating	
3	-150 150#
	-300 300#
	-600 600#
	-900 900# ²
	-15X 1500# ²
	Flange Faces
4	R RF = Raised Face (125-250RMS)
	J RTJ = Ring Type Joint ³
	F FF = Flat Face
	S RFSF = Raised Face Smooth Finish
Flange Housing Material	
5	CS Carbon steel 1018, Nickel plated
	SS Stainless steel 316L (1.4435)

990.FR Selection Guide	
Field no.	Code
6	Diaphragm Material ⁴
	SS Stainless steel 316L (1.4435)
	HC Hastelloy C276 (2.4819)
	MO Monel 400 (2.4360)
	IN Inconel 600 (2.4816)
	IC Incoloy 825 (2.4858)
	TA Tantalum
	NI Nickel 200 (2.4066)
	TI Titanium Grade 2 (3.7035)
	CA Carpenter 20 (2.4660)
	PF Stainless steel (316L) with Teflon® PFA spray-coating ⁶
	AU Stainless steel (316L) with Gold Lining 10 µin
	DP Duplex 2205 (1.4462)
Options ⁷	
XMT Material Certificate 3.1 EN10204 (metal only)	
XNC Wetted parts NACE (MR0175/MR0103 Year 2009) compliant	
7	CE4 4" Cooling element ^{1,8}
	CE8 8" Cooling element ^{1,8}

Order Code:

990.FR **X**

Field no. 1 2 3 4 5 6 7

*Additional order details _____

Diaphragm Seals > Flanged Seals > 990.28

Type 990.28

Type 990.28 pancake diaphragm seal is a one-piece design. The diaphragm is flush with the end user's gasket-sealing surface which removes all internal cavities, avoiding clogging and settlement buildup. This seal is installed between the end user's process flange and a blind back-up flange (up to 2500# classification per ASME B16.5). A wide variety of process wetted materials are available, such as solid metallic, metal- or plastic-lined, and coated. This seal is commonly installed on transmitters and pressure gauges.



Standard Features

Pressure Rating, Maximum: Maximum flange rating up to 2500# classification per ASME B16.5

Suitable Pressure Minimum:

Gauge Mechanical, Range: ≥ 15 psi

Switch or Transmitter, Span: 200" H₂O

Differential Switch or Transmitter, Span: 10" H₂O differential

Operating Temperature Range:

-130°F to 752°F (-90°C to 400°C)

Available Options

- Capillary tubing

Notes:

- 1) Radial weld-in connections are only available on 316L stainless steel housings.
- 2) Customer to outline the exact ANSI/ASME B16.5 flange pressure class connection required for any RTJ sealing face request.
- 3) All titanium design required; only threaded instrument connections available.
- 4) Teflon® PFA spray coating (PF) is not intended for full corrosion protection. It is applied as a non-stick coating only.
- 5) List options in alphabetical order at the end of the configuration code.
- 6) These diaphragm material options are only available with raised face smooth finish (RFSF) flange faces.

990.28 Selection Guide		
Field no.	Code	
1	Instrument Connection	
	N2F-R	Radial connection - 1/4" NPT female
	CPL-R	Capillary (Radial Weld-in) connection ¹
2	Process Connection (according to ASME B16.5)	
	15	1.5" flange
	20	2" flange
	30	3" flange
	40	4" flange

990.28 Selection Guide		
Field no.	Code	
3	Flange Faces	
	R	RF = Raised Face (125-250RMS)
	J	RTJ = Ring Type Joint ²
4	Housing Material	
	SS	Stainless steel 316L (1.4435)
	TI	Titanium Grade 2 (3.7035) ³
5	Diaphragm Material	
	SS	Stainless steel 316L (1.4435)
	HB	Hastelloy B3 (2.4600)
	HC	Hastelloy C276 (2.4819)
	MO	Monel 400 (2.4360)
	IN	Inconel 600 (2.4816) ⁶
	IC	Incoloy 825 (2.4858) ⁶
	TA	Tantalum
	NI	Nickel 200 (2.4066) ⁶
	TI	Titanium Grade 2 (3.7035) ³
	CA	Carpenter 20 (2.4660) ⁶
	PF	Stainless steel (316L) with Teflon®-spray-coating ^{4,6}
	AU	Stainless steel (316L) with Gold Lining 10 μin ⁶
6	Back-up Flange Material	
	NO	Without back-up flange
	CS	Carbon steel, Nickel plated
7	Back-up Flange Pressure Rating	
	-NONE	Without back-up flange
	-150R	150# RF
8	Options ⁵	
	XMT	Material Certificate 3.1 EN10204 (metal only)
	XNC	Wetted parts NACE (MR0175/MR0103 Year 2009) compliant

*Additional order details _____

Order Code:

990.28

X

Field no. 1 2 3 4 5 6 7 8

Diaphragm Seals > Flanged Seals > 990.41

Type 990.41

Type 990.41, WIKA's large displacement volume flange seal configuration, is comprised of an upper and lower housing with a welded diaphragm. This construction allows for a variety of materials to be used to meet specific requirements of applications. The large diameter diaphragm is excellent for use on low-pressure applications and with switches that contain a large displacement volume.



Standard Features

Pressure Rating, Maximum: up to 1,500 psi, limited by design or maximum flange rating

Suitable Pressure Span, Minimum:

Gauge Mechanical, Range: ≥ 15 psi

Switch or Transmitter, Span: 200" H₂O

Differential Switch or Transmitter, Span: 10" H₂O differential

Operating Temperature: -130°F to 752°F (-90°C to 400°C)

Available Options

- Other materials
- Other process connections, EN 1092-1, JIS
- Capillary tubing

Notes: (see next page)

- 1) Axial weld-in connections and cooling elements are only available on 316L stainless steel flange housings.
- 2) Customer to outline the exact ANSI/ASME B16.5 flange pressure class required for any RTJ sealing face request.
- 3) Titanium upper housings and diaphragms are only offered together for this seal model.
- 4) These lower housing materials are only offered in smooth finish facings (RFSF) and are not offered with flushing ports.
- 5) Plugs are not supplied with flushing ports as standard.
- 6) For use with silver plated metal gasket (AS) for process media temperatures up to 752°F.
- 7) Teflon® spray coating (PF) is not intended for full corrosion protection. It is applied as a non-stick coating only.
- 8) Viton® (VI) gaskets are standard for 316L (SS) and carbon steel (CS) wetted parts. Teflon® (TF) gaskets are standard for all other wetted parts configurations.
- 9) Only the PTFE-lined lower housing (SW) will not require a gasket. See note 8 for all other lower housings.
- 10) List options in alphabetical order at the end of the configuration code.
- 11) Cooling elements are welded to the diaphragm seal.
- 12) Threaded instrument connections on this model come with M6 fill ports as standard.

Type 990.22

WIKA's type 990.22 Tri-Clamp® sanitary process connection is designed to mate with an equal sized fitting. This seal is designed to assemble and disassemble from its mating fitting. This seal and mating fitting is held together via a clamp to minimize impurities entering the process during the removal and reinstallation of the seal. This seal meets the criteria set by 3A standards and is designed for applications in the pharmaceutical, and food and beverage industries.



Standard Features

Design: This seal is designed to connect with an equally sized Tri-Clamp ferrule. The external flush diaphragm with gasket provides a hygienic process connection. The standard material of construction is 316 SS. Electropolished process wetted surfaces are available as an option.

Pressure Rating, Maximum (Clamping device dependent, ref. MSHHS clamp):

1½" = 600 psi, 2" = 550 psi, 2½" = 450 psi,
3" = 350 psi, 4" = 250 psi

Suitable Pressure, Minimum:

Gauge Mechanical, Range:

1½" Process Connection:

2½" -30" Hg to 60 psi up to -30" Hg to 600 psi
4 & 4½" -30" Hg to 400 psi up to -30" Hg to 600 psi

2" Process Connection:

2½" -30" Hg to 0 psi up to -30" Hg to 550 psi
4 & 4½" -30" Hg to 100 psi up to -30" Hg to 550 psi

2½", 3", & 4" Process Connection:

-30" Hg to 0 psi up to -30" Hg to maximum pressure rating

Gauge & Absolute Switch or Transmitter, Span:

200" H₂O

Differential Switch or Transmitter, Span:

10" H₂O differential

Operating Temperature:

-10°F to 572°F (-23°C to 300°C)

990.22 Selection Guide

Field no.	Code	
		Instrument Connection
	N4F	1/2" NPT female
	N2F	1/4" NPT female
1	CPL	Capillary (Axial weld-in) connection ¹
		Process Connection (according to BS4825, Part 3)
	75	¾" (dm = 0.63")
	10	1" (dm = 1.0")
	15	1½" (dm = 1.3")
	20	2" (dm = 1.6")
	25	2½" (dm = 2.1")
2	30	3" (dm = 2.9")
		Housing Material ⁴
	SS	Stainless steel 316L (1.4435)
	TI	Titanium Grade 2 (3.7035)
3	HC	Hastelloy C276 (2.4819)
		Diaphragm Material ⁴
	SS	Stainless steel 316L (1.4435)
	ES	Electropolished 316L SS (1.4435) Ra ≤ 20 µin
	HC	Hastelloy C276 (2.4819), ¾"
	HC	Hastelloy C276 (2.4819) 1½"
	HC	Hastelloy C276 (2.4819) 2"
	TI	Titanium Grade 2 (3.7035) 1½"
4	TI	Titanium Grade 2 (3.7035) 2"
		Options ²
	XMT	Material Certificate 3.1 EN10204 (metal only)
	XEP	Certificate of Electropolish Finish
	CE4	4" Cooling element ^{1,3}
5	X3A	"3A" logo etched on seal

Notes:

- 1) Axial weld-in connections and cooling elements are only available on 316L stainless steel flange housings.
- 2) List options in alphabetical order at the end of the configuration code.
- 3) Cooling elements are welded to the diaphragm seal.
- 4) Diaphragm and housing material must match.

Order Code:

990.22 **X**

Field no. 1 2 3 4 5

*Additional order details _____

Diaphragm Seals > Plastic Seals > 990.31

Type 990.31

Type 990.31 is WIKA's version of a large threaded seal with a plastic body. The upper housing is made of PP. The diaphragm is clamped between the plastic upper and lower housing. This seal is made for applications where typical metallic components cannot withstand the process media (acids, chlorines, etc.), but is not suitable for vacuum applications.



Standard Features

Design: The plastic lower is available in PP, PVC, and PVDF. The diaphragm is a EPDM with a PTFE (Teflon®) overlay.

Pressure Rating, Maximum: See chart below

Suitable Pressure, Minimum:

Gauge Mechanical, Range: ≥ 60 psi

Switch or Transmitter, Span: 60 psi

Operating Temperature:

See table below

Notes:

- 1) Maximum working pressure (MWP) 160PSI @ 68°F. See datasheet for MWP vs. temperature relation.
- 2) Material Certificate 3.1 EN10204 not available for this seal model.
- 3) The 1/2" NPT female instrument connection is not available for 1/4" NPT female process connection configurations.

990.31 Selection Guide		
Field no.	Code	
	Instrument Connection	
	N2F	1/4" NPT female
1	N4F	1/2" NPT female ³
	Process Connection (MWP 160 PSI ¹)	
	N2F	1/4" NPT female
2	N4F	1/2" NPT female
	Upper Housing Material	
3	PP	Polypropylene
	Lower Housing Material	
	PVC	Polyvinyl chloride
	PVDF	Polyvinylidene fluoride (Kynar)
4	PP	Polypropylene
	Diaphragm Material	
5	TF	EDPM with PTFE Overlay
	Upper Housing Color	
6	Blue	Blue
	Options ²	
7	XXX	Other - consult factory

DIAPHRAGM SEALS

Order Code:

990.31 **X**

Field no. 1 2 3 4 5 6 7

*Additional order details _____

Pressure-Temperature Rating

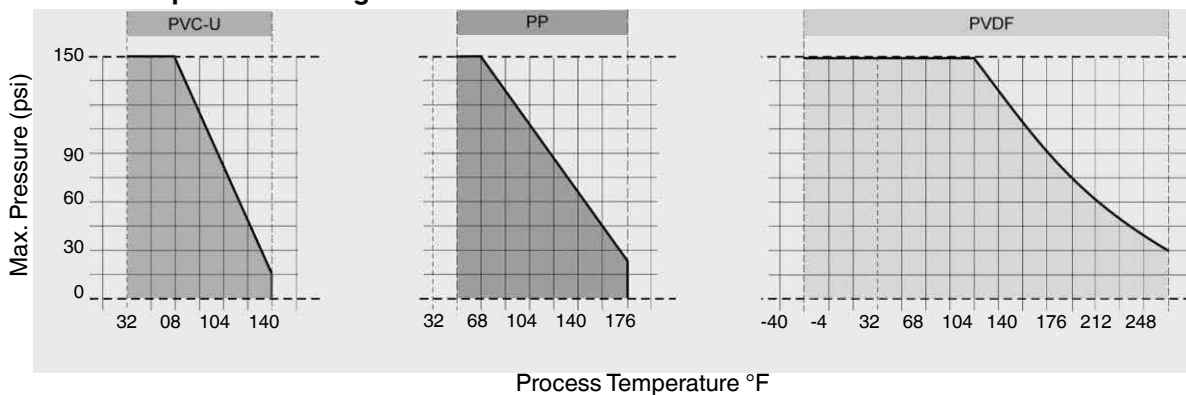

Diaphragm Seals > InLine Seals > 981.10

Type 981.10

WIKA's type 981.10 wafer InLine Seal is for flow pressure measurement. This seal becomes an integral part of the process piping system resulting in no obstructions to the direction of the flow. Suited for rapidly flowing pressure media with low to medium viscosity, this seal is designed for applications in the petrochemical, chemical and most other flow applications.



Standard Features

Design: This wafer seal is designed for bolting between two end user pipe flanges.

The outside diameter of the seal assists to obtain correct alignment during installation.

The welded seal diaphragm contains no protrusions or interruptions to the process flow. 316L SS is the most common material of construction, but additional materials are available.

Pressure Rating, Maximum: Maximum flange rating up to 2,500 classification per ASME B16.5

Suitable Pressure Minimum (dependent on process connection):

Gauge Mechanical, Range: ≥ 15 psi

Switch or Transmitter, Span: 50" H₂O

Differential Switch or Transmitter, Span: 10" H₂O differential

Operating Temperature: -130°F to 752°F (-90°C to 400°C)

Available Options

- Other materials
- Cooling element
- Capillary tubing

Notes: (see next page)

- 1) Axial weld-in connections and cooling elements are only available on 316L stainless steel flange housings.
- 2) Customer to outline the exact ANSI/ASME B16.5 flange pressure class required for any RTJ sealing face request.
- 3) List options in alphabetical order at the end of the configuration code.
- 4) Cooling elements are welded to the diaphragm seal.
- 5) For instrument assemblies, please provide detailed information on the required instrument orientation in relation to the flow-wise direction of the seal.

Type 981.10

981.10 Selection Guide			
Field no.	Code		
1	Instrument Connection ⁵		
	N4F	1/2 NPT female	
	N2F	1/4 NPT female	
	CPL	Capillary (Axial weld-in) connection ¹	
2	Process Connection --Outer Diameter		
	10	1" pipe	2.480" (63 mm)
	15	1.5" pipe	3.071" (78 mm)
	20	2" pipe	3.740" (95 mm)
	30	3" pipe	5.118" (130 mm)
	40	4" pipe	5.906" (150 mm)
3	Flange Faces		
	R	RF = Raised Face (125-250 RMS)	
	J	RTJ = Ring Type Joint ²	
	S	RFSF = Raised Face Smooth Finish	
4	Internal Diameter as per Process Connection		
	0285	1.122" (28.5 mm)	1"
	0430	1.692" (43.0 mm)	1.5"
	0545	2.145" (54.5 mm)	2"
	0825	3.248" (82.5 mm)	3"
	1070	4.212" (107 mm)	4"

981.10 Selection Guide		
Field no.	Code	
5	Face-to-Face Length	
	060	2.36" (60 mm)
	100	3.94" (100 mm)
6	XXX	Non-standard - please specify
	Housing and Diaphragm Material	
	SS	Stainless steel 316L(1.4435)
	HB	Stainless steel 316L base with Hastelloy B2 (2.4617)
	HC	Stainless steel 316L base with Hastelloy C276 (2.4819)
	MO	Stainless steel 316L base with Monel 400 (2.4360)
7	TA	Stainless steel 316L base with Tantalum
	TI	Stainless steel 316L base with Titanium Grade 2 (3.7035) - Tmax=150°C
	PF	Stainless steel 1.4571 with PFA-coating
	Options ³	
	XMT	Material Certificate 3.1 EN10204 (metal only)
7	XNC	Wetted parts NACE (MR0175/MR0103 Year 2009) compliant
	CE4	4" Cooling element ^{1,4}
	CE8	8" Cooling element ^{1,4}
	ZPS	Zero Point Stabilization - please order if steam cleaning (SIP) is possible

DIAPHRAGM SEALS

Order Code:

981.10 **X**

Field no. 1 2 3 4 5 6 7

*Additional order details _____

Diaphragm Seals > InLine Seals > 981.27

Type 981.27

The type 981.27 flanged InLine Seal is designed for flow pressure measurements. The flanged InLine Seal is installed between two end user flanges and becomes an integral part of the piping system. This seal replaces "T"s in the process piping system for installing pressure measuring instruments. This seal is non-disruptive to the process flow and assists in obtaining a true pressure reading. Suited for rapidly flowing pressure media with low to medium viscosity, this seal is designed for a variety of applications.

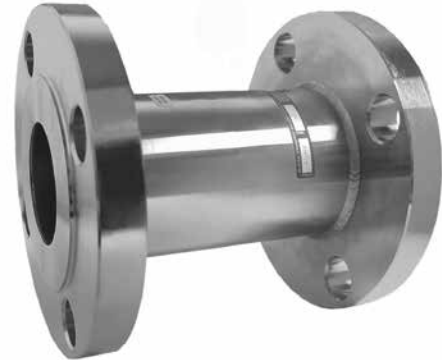

Standard Features

Design: This seal contains two ASME flange process connections. The welded thin walled cylindrical diaphragm extends the entire length of the seal body. The diaphragm does not contain any protrusions or interruptions to the process flow. 316L SS is the most common material of construction, but additional materials are available. Additional flange configurations are also available.

Pressure Rating, Maximum: Maximum flange rating per ASME B16.5

Suitable Pressure, Minimum (dependent on process connection):

Gauge Mechanical, Range: ≥ 15 psi

Switch or Transmitter, Span: 50" H₂O

Differential Switch or Transmitter, Span: 10"H₂O differential

Operating Temperature: -130°F to 752°F (-90°C to 400°C)

Available Options

- Other materials
- Other process connections, EN 1092-1, JIS
- Cooling element
- Capillary tubing

Notes: (see next page)

- 1) Axial weld-in connections and cooling elements are only available on 316L stainless steel flange housings.
- 2) ANSI/ASME B16.5 class 900 and class 1500 flanges share dimensions for NPS ≤ 2.0 -in with exception to RTJ faces. Please use code (15X) for any class 900 flange within these conditions.
- 3) Customer to outline the exact ANSI/ASME B16.5 flange pressure class required for any RTJ sealing face request.
- 4) List options in alphabetical order at the end of the configuration code.
- 5) Cooling elements are welded to the diaphragm seal.
- 6) For instrument assemblies, please provide detailed information on the required instrument orientation in relation to the flow-wise direction of the seal.

Type 981.27

981.27 Selection Guide		
Field no.	Code	
1	Instrument Connection ⁶	
	N4F	1/2 NPT female
	N2F	1/4 NPT female
	CPL	Capillary (Axial weld-in) connection ¹
2	Process Connection (according to ASME B16.5)	
	10	1" pipe
	15	1.5" pipe
	20	2" pipe
	30	3" pipe
	40	4" pipe
3	Flange Rating (according to ASME B16.5)	
	-150	150#
	-300	300#
	-600	600#
	-900	900# ²
4	Flange Faces	
	R	RF = Raised Face (125-250RMS)
	J	RTJ = Ring Type Joint ³
	S	RFSF = Raised Face Smooth Finish

981.27 Selection Guide		
Field no.	Code	
5	Internal Diameter	
	0266	1.047" (26.6 mm) for sizes 1"
	0430	1.692" (43mm) 1.5"
	0525	2.067" (52.5 mm) 2"
	0780	3.070" (78.0 mm) 3"
	1023	4.027" (102.3 mm) 4"
6	Face-to-Face Length	
	114	4.49" (114 mm) for sizes 1"
	146	5.75" (146 mm) 1.5"
	156	6.14" (156 mm) 2"
	166	6.54" (166 mm) 3" & 4"
7	Housing and Diaphragm Material	
	SS	Stainless steel 316L (1.4435)
	HB	Stainless steel 316L base with Hastelloy B2 (2.4617)
	HC	Stainless steel 316L base with Hastelloy C276 (2.4819)
	MO	Stainless steel 316L base with Monel 400 (2.4360)
	TA	Stainless steel 316L base with Tantalum
	TI	Stainless steel 316L base with Titanium Grade 2 (3.7035) - Tmax=150°C
	PF	Stainless steel 1.4571 with PFA-coating
	Options - (see note 4)	
	XMT	Material Certificate 3.1 EN10204 (metal only)
	XNC	Wetted parts NACE (MR0175/MR0103 Year 2009) compliant
	8	CE4
CE8		8" Cooling element ^{1,5}
ZPS		Zero Point Stabilization - please order if steam cleaning (SIP) is possible

DIAPHRAGM SEALS

Order Code:

981.27 **X**

Field no. 1 2 3 4 5 6 7 8

*Additional order details _____

Type 981.31

Type 981.31, the concrete InLine Seal is designed for flow pressure measurements with abrasive process media. This flanged InLine Seal is installed between two end user flanges and becomes an integral part of the piping system. This seal replaces "T"s in the process piping system for installing pressure measuring instruments. This seal is designed for the mining, wastewater, slurries and other abrasive applications. Applications within the minimum vacuum are acceptable.



Standard Features

Pressure Rating, Maximum: Maximum flange rating per ASME B16.5

Suitable Pressure, Minimum:

Gauge Mechanical, Range: ≥ 60 psi

Switch or Transmitter, Span: 60 psi

Operating Temperature: -4°F to 140°F (-20°C to 60°C)

Available Options

- Other materials
- Cooling element
- Capillary tubing

Notes:

- 1) For instrument assemblies, please provide detailed information on the required instrument orientation in relation to the flow-wise direction of the seal.
- 2) Material Certificate 3.1 EN10204 not available for this seal model.

981.31 Selection Guide

Field no.	Code	
1		Instrument Connection
	N4F	1/2 NPT female
	N2F	1/4 NPT female
2		Process Connection (according to ASME B16.5)
	20	2" flange
	30	3" flange
	40	4" flange
	6X	6" flange
	8X	8" flange
3		Flange Rating (according to ASME B16.5)
	-150	150#
4		Flange Faces
	S	RFSF = Raised Face Smooth Finish
5		Body and Flange Material
	CS	Carbon steel 1018, painted black
	SS	Stainless steel 316L(1.4435)
6		Diaphragm Material
	PU	Polyurethane, PU/80 shore
7		Options ²
	XXX	Other - consult factory

Order Code:

981.31 X

Field no. 1 2 3 4 5 6 7

*Additional order details _____

Type 981.22



Type 981.22, WIKA's sanitary InLine Seal, is designed for flow pressure measurement applications. This seal becomes an integral part of the process piping system removing disturbing turbulence, cornering dead volume, and piping "T" or other obstacles that can occur in the direction of the flow. Suited for rapidly flowing pressure media with low to medium viscosity. This seal meets the criteria set by 3A standards and is designed for applications in the pharmaceutical, and food and beverage industries.

Standard Features

Pressure Rating, Maximum:

1" and 1½" = 500 psi, 2" = 450 psi, 2½" = 400 psi,
3" = 350 psi, 4" = 200 psi

Suitable Pressure, Minimum¹:

Gauge Mechanical, Range: -30" Hg to 0 psi up to -30 Hg to maximum pressure rating

Gauge and Absolute Switch or Transmitter, Span: 50" H₂O

Differential Switch or Transmitter, Span: 10" H₂O differential

Operating Temperature ^{2,3}: -10°F to 572°F (-23°C to 300°C)

Notes:

- 1) Axial weld-in connections and cooling elements are only available on 316L stainless steel housings.
- 2) List options in alphabetical order at the end of the configuration code.
- 3) For instrument assemblies, please provide detailed information on the required instrument orientation in relation to the flow-wise direction of the seal.

981.22 Selection Guide		
Field no.	Code	
1	Instrument Connection ³	
	N4F	1/2" NPT female
	N2F	1/4" NPT female
	CPL	Capillary (Axial weld-in) connection ¹
	Process Connection	
	75	3/4" Tri-Clamp®
	10	1" Tri-Clamp®
2	15	1.5" Tri-Clamp®
	20	2" Tri-Clamp®
	25	2.5" Tri-Clamp®
	30	3" Tri-Clamp®
	40	4" Tri-Clamp®

981.22 Selection Guide		
Field no.	Code	
3	Internal Diameter	
	0157	0618" (15.7 mm) For size 3/4"
	0222	0.87" (22.2 mm) 1"
	0380	1.496" (38 mm) 1.5"
	0476	1.847" (47.6 mm) 2"
	0603	2.374" (60.3 mm) 2.5"
4	Face-to-Face Length	
	096	3.78" (96 mm) (special)
	114	4.49" (114 mm) 1"
	146	5.75" (146 mm) 1.5"
	156	6.14" (156 mm) 2" and larger
	NS	Non-Standard - please specify
5	Clamp Diameter	
	0250	0.98" (25 mm) For size 3/4"
	0505	1.99" (50.5 mm) 1" / 1.5"
	0640	2.50" (64 mm) 2.0"
	0775	3.10" (77.5 mm) 2.5"
	Housing and Diaphragm Material	
6	SS	Stainless steel 316L(1.4435)
	ES	Electropolished 316L SS (1.4435) Ra ≤ 20 µin
	HC	Stainless steel 316L base with Hastelloy C276 (2.4819)
	Options ²	
7	CE4	4" Cooling Element
	X3A	"3A" logo etched on seal
	XMT	Material Certificate 3.1 EN10204 (metal only)
	ZPS	Zero Point Stabilization - please order if steam cleaning (SIP) is possible

DIAPHRAGM SEALS

¹ Surface roughness for 316L SS and Hastelloy® C276 is ≤ 30 micro-inches

² Surface roughness for 316L SS electropolished is ≤ 15 micro-inches

Order Code: 1 2 3 4 5 6 7

981.22 -

--	--	--	--	--	--	--	--

ZZZ

*Additional order details _____

Diaphragm Seals > Seal Accessories > 910.27

Type 910.27

Type 910.27, WIKA's flushing ring is made to be installed between the end user's flange and WIKA's flanged seal configurations without a lower housing. A flushing ring facilitates the purging of trapped gas pockets or settlement from the process cavity adjacent to the seal diaphragm. This flushing ring can also be used as ports for calibration. This accessory can be made of various solid materials.

Standard Features

Pressure Rating, Maximum¹: Maximum flange rating per ASME B16.5

Available Options

- Other materials
- Other process connections, EN 1092-1, JIS

Notes:

- 1) Customer to outline the exact ANSI/ASME B16.5 flange pressure class required for any RTJ sealing face request.
- 2) List options in alphabetical order at the end on the configuration code.



910.27 Selection Guide

Field no.	Code
	Process Connection (per NPS Diameter)
	15 1.5" pipe
	20 2" pipe
	30 3" pipe
	40 4" pipe
1	XX Other- consult factory
	Flange Faces
	R RF = Raised Face (125-250RMS)
	J RTJ = Ring Type Joint ¹
2	S RFSF = Raised Face Smooth Finish
	Flushing Connection
	-1 1 X 1/8" NPT
	-2 1 X 1/4" NPT
	-3 2 x 1/8" NPT
	-4 2 x 1/4" NPT
	-5 1 X 1/2" NPT
	-6 2 X 1/2" NPT
3	-X Other- consult factory
	Flushing Ring Material
	SS Stainless steel 316L (1.4435)
	HC Hastelloy C276 (2.4819)
	MO Monel 400 (2.4360)
	CA Carpenter 20 (2.4660)
4	DP Duplex 2205 (1.4462)
	Options ²
	XMT Material Certificate 3.1 EN10204 (metal only)
	XNC Wetted parts NACE (MR0175/MR0103 Year 2009) compliant
	150 Full flange style with bolt holes, Class 150 316L SS only
	300 Full flange style with bolt holes, Class 300 316L SS only
5	PLG Provided with flushing port plug(s)

Order Code:

910.27

Field no. 1 2 3 4 5

*Additional order details _____

Diaphragm Seals > Seal Accessories > 910.ZA

Type 910.ZA

The type 910.ZA saddle seal is made to measure process flow pressure. The saddle portion of this seal (lower housing) is welded to the external surface of a pipe with a hole opening to the process flow. This seal can be used with low to high viscous process media. This construction allows for a wide variety of usable materials to be assembled to meet the requirements of most flow applications.



Standard Features

Design: The diaphragm is welded to the upper housing of the seal that allows for the removal from the lower housing without jeopardizing the integrity of the system fill fluid and installed instrument. The upper and lower housing are bolted together and sealed by use of an O-ring. The radius on this lower housing is machined to fit the contour of the outside diameter of the process pipe.

Pressure Rating, Maximum: 1,500 psi

Suitable Pressure Span, Minimum:

Gauge (Range):

2½", ≥ 15 psi

4 or 4½", ≥ 15 psi

Pressure Transmitters: ≥ 15 psi

Operating Temperature: -130°F to 500°F (-90°C to 260°C)

Available Options

- Insert available as Type 990.15
- 4" and larger
- Saddle or insert can be ordered separately

Notes: (see next page)

- 1) Axial weld-in connections and cooling elements are only available on 316L stainless steel upper housings.
- 2) Titanium upper housings and diaphragms are only offered together for this seal model.
- 3) Teflon® spray coating (PF) is not intended for full corrosion protection. It is applied as a non-stick coating only.
- 4) Viton® (VI) gaskets are standard for 316L (SS) and carbon steel (CS) wetted parts. Teflon® (TF) gaskets are standard for all other wetted parts configurations.
- 5) List options in alphabetical order at the end of the configuration code.
- 6) Cooling elements are welded to the diaphragm seal.
- 7) If only the insert (L990.15) or the saddle (910.20) is required, please consult factory.

Diaphragm Seals > Seal Accessories > 910.ZA

Type 910.ZA

DIAPHRAGM SEALS

910.ZA Selection Guide		
Field no.	Code	
1	Instrument Connection	
	N4F	1/2" NPT female
	N2F	1/4" NPT female
	CPL	Capillary (Axial weld-in) connection ¹
	Process Connection (per NPS Diameter)	
	25	2.5" pipe
	30	3" pipe
	40	4" pipe
	5X	5" pipe
	6X	6" pipe
	8X	8" pipe
	10X	10" pipe
	12X	12" pipe
2	14X	14" pipe
	Upper Housing Material	
3	CS	Carbon steel 1018, Nickel plated
	SS	Stainless steel 316L (1.4435)
	TI	Titanium Grade 2 (3.7035) ²
4	Saddle Flange Material	
	CS	Carbon steel 1018, Nickel plated
	SS	Stainless steel 316L (1.4435)
	HC	Hastelloy C276 (2.4819)
	MO	Monel 400 (2.4360)
	IN	Inconel 600 (2.4816)
	IC	Incoloy 825 (2.4858)
	NI	Nickel 200 (2.4066)
	TI	Titanium Grade 2 (3.7035)
	CA	Carpenter 20 (2.4660)
	DP	Duplex 2205 (1.4462)
	S4	Stainless steel 304L (1.4304)
5	Clamp and Support Material	
	CS	Carbon steel 1018, Nickel plated
	SS	Stainless steel 316L (1.4435)

910.ZA Selection Guide		
Field no.	Code	
6	Diaphragm Material	
	SS	Stainless steel 316L (1.4435)
	HB	Hastelloy B3 (2.4600)
	HC	Hastelloy C276 (2.4819)
	MO	Monel 400 (2.4360)
	IN	Inconel 600 (2.4816)
	IC	Incoloy 825 (2.4858)
	TA	Tantalum
	NI	Nickel 200 (2.4066)
	TI	Titanium Grade 2 (3.7035) ²
	CA	Carpenter 20 (2.4660)
	SW	Stainless steel (316L) with virgin PTFE-foil
	PF	Stainless steel (316L) with Teflon® PFA spray-coating ³
	DP	Duplex 2205 (1.4462)
	S4	Stainless steel 304L (1.4304)
	Gasket Material ⁴	
	7	VI
TF		Teflon® (PTFE) max. 500 °F
8	Options ⁵	
	XMT	Material Certificate 3.1 EN10204 (metal only)
	XNC	Wetted parts NACE (MR0175/MR0103 Year 2009) compliant
	CE4	4" Cooling element ^{1,6}

Order Code:

910.ZA **X**

Field no. 1 2 3 4 5 6 7 8

*Additional order details _____

Request For Quote Form

This form contains spaces for all pertinent information when selecting the proper diaphragm seal. Please make a copy of this form and fill in as much information as you have available when requesting quotations or technical help from the factory.

Contact Name: _____ **Date:** _____

Company Name: _____
Telephone # _____ **Fax #:** _____
E-mail Address _____

SECTION 1

Process Media

Common Name / Description: Example: Sulfuric Acid 90% Conc. _____
 Temperature (°C): Process @ Max. Pressure: Min. _____ Normal _____ Max. _____
 Transmitter/Gauge: Min. _____ Normal _____ Max. _____
 Ambient: Min. _____ Normal _____ Max. _____
 Pressure (psi): Static (Working Press.): Min. _____ Normal _____ Max. _____
 Vacuum (psia @ °C): Normal _____ @ _____ °C
 Max. _____ @ _____ °C

SECTION 2

Instrument Requirements





Measurement Range: _____
 Wetted Parts: _____
 Connection to Diaphragm Seal: [Direct] [Cooling Element] [Capillary] [Length]
 Orientation: _____

Request For Quote Form



SECTION 2 Continued

Instrument Type

Gauge  Type # _____
 Case Size (Inches): [2"] [2½"] [3½"] [4"] [4½"] [6"]
 Range: _____ to _____ [psi] [bar] Other _____

-or- Location of Instrument Connection: [LM]  [LBM]  [CBM] 
 Instrument Connection Size and Type: [¼" NPT] [½" NPT] [Female]  [Male]  Other _____

Transmitter  Type # _____
 -or- Range: _____ to _____ [psi] [bar] Other _____

Instrument Connection Size and Type: [¼" NPT] [½" NPT] [Female]  [Male]  Other _____

Switch  Please provide specifics _____

Pressure Switch Point (Upscale): _____ [psi] [bar] Other _____

Pressure Switch Point (Downscale): _____ [psi] [bar] Other _____

Additional Details: _____

SECTION 3

Diaphragm Seal Requirements

Process Connection

Threaded? _____ Standard: _____ Nominal Size: _____ Facing: _____

Flanged? _____ Standard: _____ Nominal Size: _____ Pressure Class: _____ Sealing Style: _____

Sanitary? _____ Standard: _____ Nominal Size: _____ Facing: _____

Other? _____ Standard: _____ Description: _____

Wetted Material: _____ System Fill Fluid: _____

Additional Details: _____

DIAPHRAGM SEALS

Diaphragm Seals > General Seal Information > Mounting Options

Mounting Options

Cooling Element

The cooling element is intended to protect the pressure instrument from high or low process temperature. Air flow across heat exchanging fins reduces or increases the temperature of the system fill fluid to protect the pressure measuring instrument.

The cooling element is recommended for process temperatures above 300°F and should be "direct mounted" between the pressure instrument and the diaphragm seal. Silicone fill is recommended. WIKA's cooling element is effective for temperature reductions of 200°F, depending upon ambient conditions. The all stainless steel construction is back welded to the stainless steel upper housing or flange.

Capillary line

A stainless steel capillary, with or without stainless steel armor, provides a connection between the pressure instrument and the diaphragm seal. It protects the pressure instrument from high or low process temperatures and provides distant or remote reading.

The capillary should be selected as short as possible, since changes in ambient temperature conditions may considerably affect the accuracy and response time of the pressure instrument. Standard length is five feet; other lengths are available upon request.

Installation on mechanical gauges normally requires a gauge support and gauge adaptor or other surface mounting provisions.

Any level difference between pressure instrument and diaphragm seal will cause a pressure indication error. The level difference can be compensated for during calibration of the diaphragm seal assembly if the level difference is known.

Minor corrections can be made on site by means of an adjustable pointer or zero adjustment of the pressure instrument.

Gauge Support and Adaptor

The gauge support and adaptor allows a wall mounting installation of the pressure instrument by clamping it to the gauge adaptor. Material: gauge support - aluminum or stainless steel, gauge adaptor - stainless steel.



Diaphragm Seal Assembly with Cooling Element.
(Cooling element always welded to upper housing)

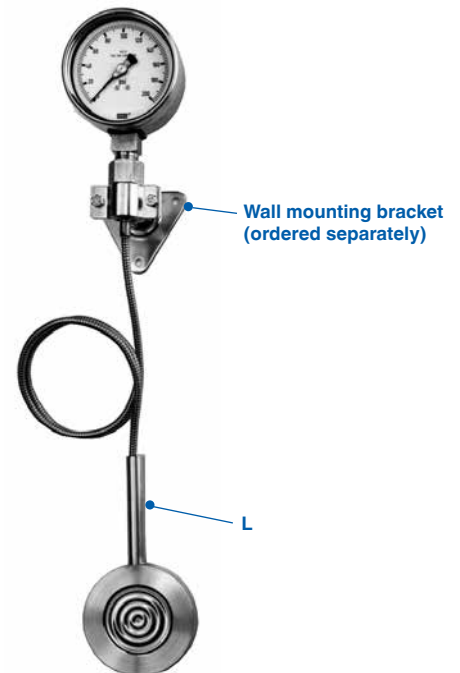

Diaphragm Seal Accessories

	Service Temperature Ratings		Application Notes
	[Vacuum Pressure]	[Positive Gauge Pressure]	
KN2 Silicone DC200 (50 cSt)	-40°F to +302°F	-40°F to +572°F	Standard
KN68 Silicone DC200 (10 cSt)	-103°F to +249°F	-103°F to +482°F	Standard
KN17 (Low Temp.)Silicone oil (4cSt)	-130°F to + 176°F	-130°F to +392°F	Low Temperature
KN30 Methylcyclopentane	N/A	-202°F to +140°F	Lower Temperature
KN93 (Food Grade) Silicone DC200 (350 cSt)	N/A	0 to +572°F	Sanitary/Food FDA 21 CFR 173.340
KN7 Glycerine 99.7% USP	N/A	+60°F to +464°F	Standard, Sanitary/Food FDA 21 CFR 182.1320
KN12 (86.5%/13.5%) Glycerine/Water	N/A	+14°F to +248°F	Sanitary/Food
KN59 Neobee® M20	N/A	-31°F to +500°F	Sanitary/Food FDA 21 CFR 172.856, 21 CFR 174.5
KN92 Mineral Oil	+4 to +338°F	+4°F to +500°F	Sanitary/Food FDA 21 CFR 172.878, 21 CFR 178.3620(a), USP, EP
KN64 Deionized (DI) Water	N/A	+34°F to +185°F	Ultrapure Media
KN75 DI Water/Propanol	N/A	-22°F to 140°F	Ultrapure Media
KN32 Silicone DC704	+4°F to +350°F	+4°F to +625°F	High Temperature
KN3.2 (High Temp.) Silicone oil	-4°F to +392°F	-4°F to +752°F	Higher Temperature
KN8 Fluorolube® FS-5	N/A	-40°F to +392°F	Chemically Inert
KN21 Halocarbon® 6.3	-40°F to +176°F	-40°F to +346°F	Chemically Inert

DIAPHRAGM SEALS

Diaphragm Seal Accessories

				Part Number
Cooling Element	Material 316L	1/2" NPT female x 1/2" NPT male		1584510
		1/4" NPT female x 1/4" NPT male		1600885
316Ti SS Unarmored Capillary with M6 Fill Port	5 FT. Length	1/2" NPT female x 1/2" NPT male		1030841
		1/4" NPT female x 1/4" NPT male		1030868
		Additional cost for over 5 FT.		
304SS Armored Capillary with M6 Fill Port	5 FT. Length	1/2" NPT male x 1/2" NPT female		1030850
		1/4" NPT male x 1/4" NPT female		1030876
		Additional cost for over 5 FT.		
		316SS Armor		
		PVC Sleeving for Armored Capillary		
910.16 DIN 16 281 Form H 4"Wall Mount with Adaptor	Mount Material	Adaptor Material	Instrument Conn.	
	Aluminum	Stainless steel	1/4" NPT	4380866
			1/2" NPT	4295898
	Stainless steel	Stainless steel	1/4" NPT	4380857
			1/2" NPT	4384046
	Low Temperature Overfill (see note 1)			
Gauge tack weld to seal (SS socket to SS seal Upper Housing)				291
Gauge back weld to seal (SS socket to SS seal Upper Housing)				292
Cleaning for Oxygen / Chlorine service (ASME B40.100 Level IV)				290
Certificate of Compliance by Industry Standards				776
NIST Calibration Certificate for Diaphragm Seal Systems (mechanical only)				405
Factory Calibration Report (not third party traceable)				
Material Certificate (MTR) per EN 10204 3.1 (metal only)				784
Hydrostatic test 1.5X				782
Hydrostatic test 2.0X				787
Metallic Material Certificate NACE (MR0175/MR0103 Year 2009)				788
Certificate of PMI Testing				2247381
Certificate of Helium Leak Testing per EN10204 3.1				777
General Dimensional Drawing (no special configurations)				
Certified Dimensional Drawing (as per customer order)				

Note:

- 1) For outdoor applications with extended period of exposure to freezing conditions.

Bimetal Operating Principle

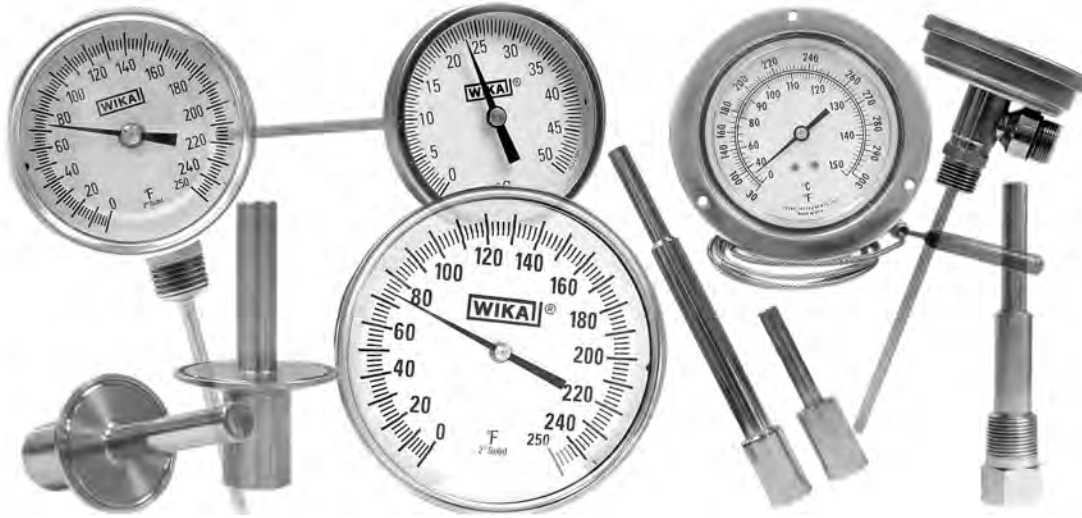

The temperature is measured with a bimetal system inside the thermometer stem. The bimetal system consists of two metal strips bonded together that have different expansion coefficients. Therefore, one strip will expand faster than the other causing the bimetal strip to curl in proportion to its temperature. The bimetal system is helically wound and heat treated for long term stability. Temperature variations cause the bimetal strip to unwind or wind tighter, which in turn rotates the pointer.

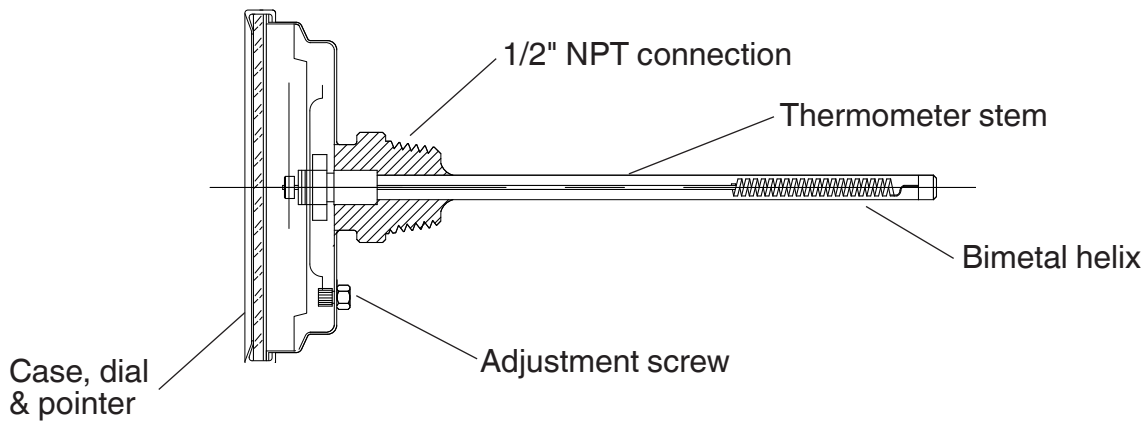

Bimetal Thermometers General Specifications

Case: Sturdy, corrosion resistant series 304 SS case and bezel. Designed and constructed to provide a hermetic seal (IP65, NEMA 4X) which prevents crystal fogging and damage caused by moisture to the working components. Install thermometer so the maximum temperature case is kept below 200°F at all times.

Dial: Anti-parallax heavy gauge aluminum with white matte finish to reduce glare. Dished form with Celsius on lower inner plane and Fahrenheit on raised outer plane offers accurate indication of both scales (if equipped with dual scales).

External Reset: (comes standard on all process grade bimetal thermometers) A slotted-hex adjustment head offers screwdriver or wrench use to field calibrate the thermometer. This feature allows maximum accuracy at a selected area of temperature range. O-ring gasket prevents leakage and maintains weather tight seal. Note: use well-agitated bath and accurate test thermometer when making any adjustment.

Standards: WIKA manufactures ASME B40.3 bimetal thermometers, which meet or exceed the standard issued by the American Society of Mechanical Engineers.

Window: Optically clear, strong glass, gasketed to maintain weather tight integrity. Acrylic and Lexan® windows are available as an option but not recommended for case temperature exceeding 200°F maximum (150°F for plastic/acrylic window).

Pointer: Balanced, lightweight aluminum with matte black finish.

Stem: 304 SS welded at tip and case connector to prevent leakage. ¼" diameter is standard, ⅜" is available. Stem lengths to 72" are available, as well as 316 SS stem and connector assemblies.

Immersion: For accurate temperature readings, immerse the stem a minimum of 2" in agitated liquid or 4" in moving air or gas.

Over Range: Temporary over or under range of 50% of scale up to 500°F or 260°C will not affect the instrument's accuracy.

Bimetal Element: An extremely responsive temperature sensing helix which has been carefully sized and tested, heat treated and aged to relieve inherent stresses and ensure continued accuracy.

Accuracy: Guaranteed to be accurate to within 1% of full scale (Grade A per ASME B40.3). Calibration is to standards traceable to the National Institute of Standards and Technology.

Hermetic Seal: Hermetically sealed per ASME B40.3. Guaranteed not to fog up (IP65, NEMA 4X).

Dampening: Inert gel to minimize pointer oscillation.

7-Year Warranty: WIKA extends a 7-year warranty on standard types 30, 31, 50, 51, 32 and 52. Such units are guaranteed to be free from defects in material and workmanship under normal use and service. For all other models, WIKA extends a 1-year warranty. Complete details available upon request.

Filled Thermometer Policy: Silicone filling is available on selected types for ranges between -40°F and 500°F. WIKA does not recommend use of filled instruments for continual use at operating temperatures above of 400°F (204°C) or below -100° F(-70° C). Under no circumstances will an instrument warranty apply or will WIKA assume any liability for use above these temperatures. Per ASME B40.3, plain glass windows must not be used on filled thermometers due to expansion of fill fluid and potential lens breakage. Note: for stem lengths over 24"- consult factory.

Thermowells are recommended for pressure, corrosive, fluid or high velocity applications.



Mechanical Temperature > Bimetal Thermometers > TI.1005

Type TI.1005

Type TI.1005 is a bimetal dial thermometer requiring no power to deliver its quick, accurate readings. The 1" dial is easy to read. Stem length is 5". Thermometer includes a pocket case which can be used to hold the stem.



Standard Features

Scale:	As indicated	Reset:	Yes; 7/16" hex hub adjustment
Range:	(°F); As indicated	Stem diameter:	.142"
Window:	Lexan	Accuracy:	±1% of full range span (ASME B40.3 - Grade A)
Connection:	Plain, 7/16" hex hub adjustment		

Type	TI.1005
Connection	Plain
Dial Size	1"
Stem Length	5"
Scale	°F
-40/160 °F	1005219D
0-220 °F	1005223D
50/550 °F	1005216D

Stock items shown in blue print.

Mechanical Temperature > Bimetal Thermometers > TI.ST

Type TI.ST

WIKA dual magnet surface mount thermometers are problem solvers. Type TI.ST is an inexpensive, easy-to-use, accurate surface mounting thermometer, which attaches to any ferrous metal surface, giving unlimited localized temperature indication. The specially-designed bimetal sensing element and housing provides quick readings with an accuracy of ±2% of full scale range. These 2" dial thermometers feature steel cases, glass windows, polished aluminum dials with very legible graduations and are available in ranges listed below. WIKA dual magnet mount surface thermometers are the ideal choice for ovens, boilers, process lines, motors, generators, or anywhere a temporary or permanent surface temperature is to be measured.



Standard Features

Dial:	2"
Depth:	1/2"
Accuracy:	±2% of full range span
Reset:	No

Type	TI.ST
Connection	Surface
Dial Size	2"
Stem Length	N/A
Scale	°F or °C
0/250 °F	ST206MW
0/500 °F	ST228MW
-20/120 °C	ST106MW
-70/70 °C	ST101MW

Stock items shown in blue print.

Mechanical Temperature > Bimetal Thermometers > TI.20

Type TI.20

Type TI.20 thermometers are high-quality, economical thermometers designed for limited space and OEM applications. All type TI.20 bimetal thermometers carry a 1-year warranty.



Standard Features

Case:	304 SS	Over Range:	Temporary over or under range tolerance of 50% of scale up to 500°F (260°C)
Dial:	Anti-parallax or flat dial, heavy gauge aluminum with white matte finish	Accuracy:	±1% of full range span per Grade A, ASME B40.3
Window:	Fully gasketed glass; Lexan® available	Connection:	¼" NPT, 304 SS
Reset:	N/A	Stem Lengths:	2½" to 24"
Hermetic Seal:	Per ASME B40.3	Shipping Weight:	Stem length 2½" - 9" = 6oz.** (**weights of individual thermometers)
Stem:	¼" diameter; 304 SS, TIG welded at tip and case connection		
Dampening:	Inert gel to minimize pointer oscillation		

Type	TI.20
Connection	1/4" NPT Back
Dial Size	2"
Stem Length	2½"
Scale	°F & °C
0/250 °F & °C	20025D006G2

Stock items shown in **blue** print.

Notes:

1. Stem lengths are available from 2½" to 24".
2. Ranges from -100°F (-70°C) to 1,000°F (550°C) are available.
3. Silicone fill not available.
4. Thermowells are recommended for pressure, corrosive, fluid or high velocity applications.

Mechanical Temperature > Bimetal Thermometers > TI.T20 / TI.T17

Type TI.T20 / TI.T17

Count on WIKA laboratory thin stem thermometers to deliver fast, extremely accurate readings. These thermometers include beaker clip and reset feature on plain connections only. No external adjustment available on threaded connections. All type TI.T20 bimetal thermometers carry a 1-year warranty.



Standard Features

Case:	304 SS
Dial:	Heavy gauge aluminum with white matte finish
Window:	Fully gasketed glass standard; Lexan® available
Reset:	7/16" hex hub adjustable (not available with threaded connection)
Hermetic Seal:	Per ASME B40.3; guaranteed not to fog up
Stem:	0.150" diameter; 304 SS, TIG welded at tip and case connection
Dampening:	To minimize pointer oscillation

Over Range:	Temporary over or under range tolerance of 50% of scale up to 500°F (260°C)
Accuracy:	±1% of full range span Grade A per ASME B40.3
Connection:	Plain, 7/16" hex hub with no threads
Stem Lengths:	5", 8", 12", 15" and 18"
External Reset:	Adjustable on plain connection only
Shipping Weight:	Stem length 2.5"- 9"= 4oz.** (**weights of individual thermometers)

Sample Part Number: T20 050 2 24 D0 G 0 S C

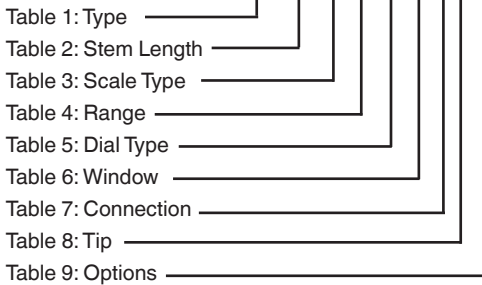

Table 1 & 2 - Type & Stem Length

Type TI.T17 - 1 3/4" Back Connected						
Stem Length	2.5"	5"	8"	12"	15"	18"
Code	025	050	080	120	150	180
Type TI.T20 - 2" Back Connected						
Stem Length	2.5"	5"	8"	12"	15"	18"
Code	025	050	080	120	150	180

Table 3 - Scale Type

Code	Description
0	Dual Scale °F & °C
1	°C Only
2	°F Only

Table 7 - Connection

Code	Description
0	Plain
1	1/8" NPT*
2	1/4" NPT*

* No external adjustment

Table 4 - Standard Ranges

Code	Description	°C Only	°F Only
03 ¹⁾	25/125°F & -5/50°C	0/50°C	25/125°F
04 ²⁾	0/140°F & -20/60°C	N/A	0/140°F
05 ²⁾	0/200°F & -15/90°C	0/100°C	0/200°F
08	50/300°F & 10/150°C	0/150°C	50/300°F
10 ²⁾	50/500°F & 10/260°C	0/250°C	50/500°F
11	150/750°F & 65/400°C	0/300°C	150/750°F
19 ²⁾	-40/160°F & -40/70°C	-40/70°C	-40/160°F
24 ²⁾	0/220°F & -10/110°C	-10/110°C	0/220°F
34 ²⁾	0/180°F & -18/82°C	-18/82°C	0/180°F

1) Minimum 3" stem - all connectors

2) Minimum 3" stem threaded connections

Table 5 - Dial Type

Code	Description
D0	WIKA Standard

Table 6 - Window

Code	Description
G	Glass
L	Lexan®

Table 8 - Tip

Code	Description
S	Sharp
B	Blunt

Table 9 - Options

Code	Description
C	Beaker clip
0	None

Mechanical Temperature > Bimetal Thermometers > TI.30 / TI.50

Type TI.30 / TI.50

WIKA bimetal thermometers are ideal for most rugged industrial temperature measurement applications. The hermetically-sealed case offers protection from weather and dust, and is guaranteed against fogging up. WIKA type TI.30 and TI.50 thermometers are guaranteed for 7 years.



Standard Features

Case:	304 SS	Over Range:	Temporary over or under range tolerance of 50% of scale up to 500°F (260°C)
Dial:	Anti-parallax, heavy gauge aluminum with white matte finish	Accuracy:	±1% full range span (ASME B40.3 Standard)
External Reset:	Slotted hex adjustment	Shipping Weight:	Type 30: stem length 2½"-9"=12oz. Type 50: stem length 2½"-9"=1lb.8oz. (weights of individual thermometers)
Window:	Fully gasketed glass		
Hermetic Seal:	Per ASME B40.3, IP65, NEMA 4X		
Stem:	¼" diameter; 304 SS, TIG welded at tip and case connection. ⅜" diameter available		
Dampening:	Inert gel to minimize pointer oscillation		

Type	TI.30				
Connection	1/2" NPT Back				
Dial Size	3"				
Stem Length	2½"	4"	6"	9"	12"
-40/120 °F	30025D202G4	30040D202G4	30060D202G4	30090D202G4	30120D202G4
0/250 °F	30025D206G4	30040D206G4	30060D206G4	30090D206G4	30120D206G4
50/550 °F	30025D216G4	30040D216G4	30060D216G4	30090D216G4	30120D216G4
-40/120 °F & °C	30025D002G4	30040D002G4	30060D002G4	30090D002G4	30120D002G4
0/250 °F & °C	30025D006G4	30040D006G4	30060D006G4	30090D006G4	30120D006G4
50/500 °F & °C	30025D010G4	30040D010G4	30060D010G4	30090D010G4	30120D010G4

Type	TI.50			
Connection	1/2" NPT Back			
Dial Size	5"			
Stem Length	2½"	4"	6"	9"
-40/120 °F	50025D202G4	50040D202G4	50060D202G4	50090D202G4
0/250 °F	50025D206G4	50040D206G4	50060D206G4	50090D206G4
50/550 °F	50025D216G4	50040D216G4	50060D216G4	50090D216G4
-40/120 °F & °C	50025D002G4	50040D002G4	50060D002G4	50090D002G4
0/250 °F & °C	50025D006G4	50040D006G4	50060D006G4	50090D006G4
50/500 °F & °C	50025D010G4	50040D010G4	50060D010G4	50090D010G4

Available Options

- Stem lengths: (in inches) 2½" to 72"
- Silicone fill
- Custom dials
- Min-max pointer
- Union locknut
- Dampened movement
- Window: Lexan®, acrylic, shatterproof

Stock items shown in blue print.

Mechanical Temperature > Bimetal Thermometers > TI.31 / TI.51

Type TI.31 / TI.51

WIKA TI.31 and TI.51 bimetal thermometers offer the same features as the TI.30 and TI.50, with a fixed lower mount (bottom) connection. The hermetically-sealed case offers protection from weather and dust, and is guaranteed against fogging up. The TI.31 and TI.51 have a 7-year guarantee.



Standard Features

Case:	304 SS	Over Range:	Temporary over or under range tolerance of 50% of scale up to 500°F (260°C)
Dial:	Anti-parallax, heavy gauge aluminum with white matte finish	Accuracy:	±1% full range span per ASME B40.3
External Reset:	Slotted hex adjustment	Shipping Weight:	Type 31: stem length - 2½" - 9" = 12oz.** Type 51: stem length - 2½" - 9" = 1lb. 10oz.** (*weights of individual thermometers)
Window:	Fully gasketed glass standard		
Hermetic Seal:	Per ASME B40.3, IP65, NEMA 4X		
Stem:	¼" diameter; 304 SS, TIG welded at tip and case connection. ⅜" diameter available		
Dampening:	Inert gel to minimize pointer oscillation.		

Type	TI.31		
Category	Process grade thermometer, resettable		
Datasheet	TI.31		
Connection	1/2" NPT Lower		
Dial Size	3"		
Stem Length	2½"	4"	6"
-40/120 °F	31025D202G4	31040D202G4	31060D202G4
0/250 °F	31025D206G4	31040D206G4	31060D206G4
50/550 °F	31025D216G4	31040D216G4	31060D216G4

Available Options

- Stem lengths: (In inches) 2½" to 72"
- Silicone fill, custom dials, min-max pointer, union locknut, union connection
- Window: Lexan®, acrylic, shatterproof, sharp tip, dampened movement
- RS= Ride side connection location
- LS= Left side connection location
- TS= Top side connection location

Stock items shown in blue print.

Note: TI.51, 5" dial thermometer also available. Consult factory for details.

Mechanical Temperature > Bimetal Thermometers > TI.32 / TI.52

Type TI.32 / TI.52

WIKA TI.32 and TI.52 bimetal thermometers are similar to TI.30 and TI.50 but with an all-angle swivel connection. The hermetically-sealed case offers protection from weather and dust, and is guaranteed against fogging up. WIKA TI.32 and TI.52 thermometers are guaranteed for 7 years.



Standard Features

Case:	304 SS	Over Range:	Temporary over or under range tolerance of 50% of scale up to 500°F (260°C)
Dial:	Anti-parallax, heavy gauge aluminum with white matte finish	Accuracy:	±1% of full scale per ASME B40.3
External Reset:	Slotted hex adjustment	All Angle Case:	Rotation of 360° and stem variation of more than 180°.
Window:	Fully gasketed glass	Shipping Weight:	Type 32: stem length 2½"- 9"= 1lb. Type 52: stem length 2½"- 9"= 2lbs. (weights of individual thermometers)
Hermetic Seal:	Per ASME B40.3, IP65, NEMA 4X		
Stem:	¼" diameter; 304 SS, TIG welded at tip and case connection. ⅜" diameter available		
Dampening:	Inert gel to minimize pointer oscillation.		

Type	TI.32				
Connection	1/2" NPT all angle				
Dial Size	3"				
Stem Length	2½"	4"	6"	9"	12"
-40/120 °F	32025D202G4	32040D202G4	32060D202G4	32090D202G4	32120D202G4
0/250 °F	32025D206G4	32040D206G4	32060D206G4	32090D206G4	32120D206G4
50/550 °F	32025D216G4	32040D216G4	32060D216G4	32090D216G4	32120D216G4

Type	TI.52				
Connection	1/2" NPT all angle				
Dial Size	5"				
Stem Length	2½"	4"	6"	9"	12"
-40/120 °F	52025D202G4	52040D202G4	52060D202G4	52090D202G4	52120D202G4
0/250 °F	52025D206G4	52040D206G4	52060D206G4	52090D206G4	52120D206G4
50/550 °F	52025D216G4	52040D216G4	52060D216G4	52090D216G4	52120D216G4
-40/120 °F & °C	52025D002G4	52040D002G4	52060D002G4	52090D002G4	52120D002G4
0/250 °F & °C	52025D006G4	52040D006G4	52060D006G4	52090D006G4	52120D006G4
50/500 °F & °C	52025D010G4	52040D010G4	52060D010G4	52090D010G4	52120D010G4

Stock items shown in blue print.

Available Options

- Stem lengths: (In inches) 2½" to 72"
- Silicone fill, custom dials, min-max pointer, Union locknut, Union connection
- Window: Lexan®, acrylic, shatterproof

Type TI.33 / TI.34 / TI.53 / TI.54

WIKA's industrial grade bimetal dial thermometers, TI.33, 34, 53 and 54 are an ideal choice where a weather-resistant, tamper-proof thermometer is needed. Each thermometer includes a 1-year warranty.



Standard Features

Case:	304 SS
Dial:	Anti-parallax, heavy gauge aluminum with matte finish
Window:	Fully gasketed glass
Hermetic Seal:	Per ASME B40.3, IP65, NEMA 4X
Stem:	1/4" diameter; 304 SS, TIG welded at tip and case connection. 3/8" diameter available
Accuracy:	±1% of full range span per Grade A, ASME B40.3
Over Range:	Temporary over or under range tolerance of 50% of scale up to 500°F (260°C)

Shipping Weight:	Type 33 & 34: stem length - 2 1/2" - 9" = 12oz. Type 53: stem length - 2 1/2" - 9" = 1lb. 8oz. Type 54: stem length - 2 1/2" - 9" = 12oz. (*weights of individual thermometers)
-------------------------	--

Note: Silicone-filled, dampened movement, min/max pointer, dry with plug, .375 stem and 316 wetted parts not available

Type	TI.33			
Connection	1/2" NPT back			
Dial Size	3"			
Stem Length	2 1/2"	4"	6"	9"
0/250 °F	33025D206G4	33040D206G4	33060D206G4	33090D206G4
50/550 °F	33025D216G4	33040D216G4	33060D216G4	33090D216G4

Stock items shown in blue print.

Type Descriptions

Type 33 (TI.33) = 3" back connection
Type 34 (TI.34) = 3" bottom connection
Type 53 (TI.53) = 5" back connection
Type 54 (TI.54) = 5" bottom connection

Available Options

- Stem lengths from 2 1/2" to 24"
- Ranges from -100°F (-70°C) to 1,000°F (550°C)
- Special ranges, custom dials, stems, connections and windows
- Window: Lexan®, acrylic, shatterproof
- Sharp tip

Ordering Bimetal Thermometers

Sample Part Number: 30 025 D 2 06 G 4 XX X X

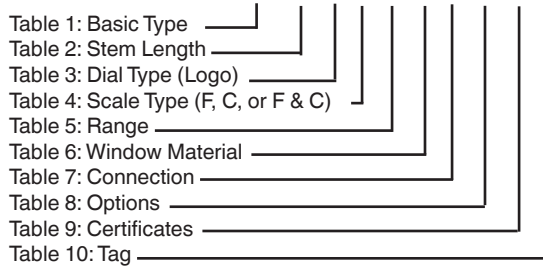

Table 1 - Basic Type

Process Grade - Resettable		Industrial Grade - Non-Resettable	
Type	Description	Type	Description
30	3" Back connected	20	2" Back connected
31	3" Bottom connected	33	3" Back connected
32	3" Adjustable angle	34	3" Bottom connected
50	5" Back connected	53	5" Back connected
51	5" Bottom connected	54	5" Bottom connected
52	5" Adjustable angle		

Stem lengths above 24" are not available with non-resettable models

Table 2 - Stem Length - specify as XX.X" with no decimal point, see "code"

Stem Length	2.5" - 9"	12"	15"	18"	24"	30"	36"	42"	48"	54"	60"	66"	72"
Code	025-090	120	150	180	240	300	360	420	480	540	600	660	720

Table 3 - Dial Type

Code	Description
D	WIKA Standard logo
X	Special

Table 4 - Scale Type

Code	Description
0	Dual scale °F & °C
1	Single scale °C
2	Single scale °F

Table 5 - Range

Code	Dual Scale						Single Scale	
	°F Range	Figure Int.	Div.	°C range	Figure Int.	Div.	°F Range	°C Range
01 ³	-100/150°F	20°	2°	-70/70°C	10°	1°	-100/150°F	-70/70°C
13	-80/120°F	20°	2°	-60/50°C	10°	1°	-80/120°F	-60/50°C
02	-40/120°F	20°	2°	-40/50°C	10°	1°	-40/120°F	-50/50°C
14	-20/120°F	20°	2°	-30/50°C	10°	1°	-20/120°F	-30/50°C
19	-40/160°F	20°	2°	-40/70°	10°	1°	-40/160°F	-40/70°C
23 ¹	0/100°F	10°	1°	-20/40°C	5°	½°	0/100°F	-20/40°C
03 ¹	25/125°F	10°	1°	-5/50°C	5°	½°	25/125°F	0/50°C
15 ¹	30/130°F	10°	1°	0/55°C	5°	½°	30/130°F	0/55°C
04	0/140°F	10°	1°	-20/60°C	5°	½°	0/140°F	-20/60°C
05	0/200°F	20°	2°	-15/90°C	10°	1°	0/200°F	0/100°C
06	0/250°F	20°	2°	-20/120°C	10°	1°	0/250°F	-20/120°C
07	20/240°F	20°	2°	-5/115°C	10°	1°	20/240°F	-10/110°C
08	50/300°F	20°	2°	10°/150°C	10°	1°	50/300°F	0/150°C
09	50/400°F	50°	5°	10/200°C	20°	2°	50/400°F	0/200°C
10	50/500°F	50°	5°	10/260°C	20°	2°	50/500°F	0/250°C
16 ³	50/550°F	50°	5°	10/290°C	20°	2°	50/550°F	10/290°C
17 ³	0/600°F	100°	10°	-20/315°C	50°	5°	0/600°F	-20/315°C
11 ³	150/750°F	100°	10°	65/400°C	50°	5°	150/750°F	0/300°C
18 ³	100/800°F	100°	10°	40/425°C	50°	5°	100/800°F	0/450°C
12 ^{2,3}	200/1,000°F	100°	10°	100/540°C	50°	5°	200/1,000°F	100/550°C

Notes:

1. Not available with 2½" stem
2. Not recommended for continued use over 800°F
3. Silicone fill not available

Ordering Bimetal Thermometers

Sample Part Number: 30 025 D 2 06 G 4 XX X X

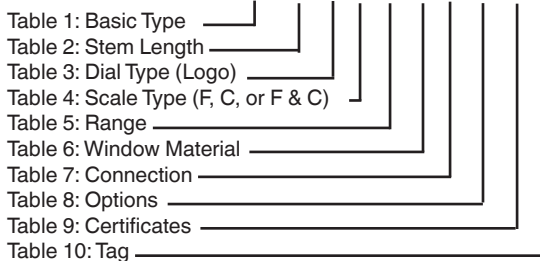

Table 6 - Window	
Code	Description
A	Acrylic lens
L	Lexan® lens
S ¹	Shatterproof lens
G ¹	Glass
¹ not available with silicone fill	

Table 7 - Process Connection	
Code	Description
0	Plain conn.
1	1/8 NPT
2	1/4 NPT
3	3/8 NPT
4	1/2 NPT
5	G 1/2 B
7	Union conn.

Table 8 - Options	
Code	Description
DM	Dampened movement
SF	Silicone fill
ST	Sharp tip
MM	Min/max pointer
LS	Left side
RS	Right side
TS	Top side
DF ²	Dry w/plug
² Prepares unit for liquid case filling and shipped dry	

0.375 Stem Diameter Upgrade Option	
Code	Description
HA	Full length
HD	Reduced tip
HS	Reduced w/sharp tip

316 SS Wetted Parts Upgrade for 0.250 Stem Diameter	
Code	Description
SS	316 SS wetted parts

Table 9 - Certificates	
Description	Code
NIST Factory Certificate of Accuracy	I

Accessories	
Part Number	Description
TA-600-011	1/2" Union locknut
TA800-0T85	T-85 conv. kit
TA800-0020	1/2" NPT duct flange
2256045	5.3 oz. tube heat transfer compound for use in thermowells

Notes:
Certificate of compliance available at no charge

Bimetal Thermometers Options



DAMPENED MOVEMENT

Dampened Movement

Engineered solution providing benefits of case fill in a dry configuration. This silicone-free option provides dampening in tough environments at all available temperature ranges. Available in all process grade models.

T-85 Thermowell Conversion Kit

This conversion kit offers an easy, inexpensive way to install a WIKA bimetal thermometer in a glass industrial thermometer's thermowell. For more information, please consult factory. To order, specify part number **TA800-0T85**.

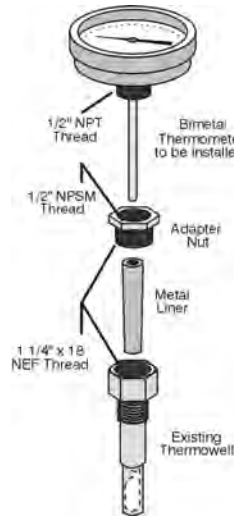

Adjustable Union Connection

The WIKA adjustable union connection allows for the installation of a type 32 or 52 adjustable angle thermometer without rotating the case. Ideal for use in a confined space.

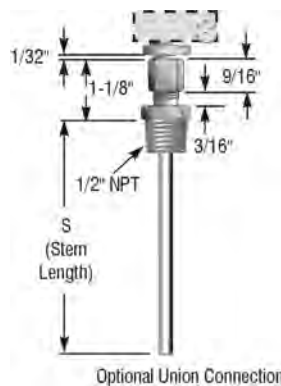

Left, Right or Top Connection

All WIKA 3" and 5" bottom connected thermometers are available with the connection oriented to the left, right or top. Please see "How to Order" on next page for this option.

Not Shown

- Heavy duty 3/8" stems and 3/4" stems with 2 1/2" x 1/4" OD sensitive portion available
- Thermometers may be ordered with sharp tips for piercing media to be measured
- 316 SS wetted parts are available
- 1/2" NPT duct flange
- Acrylic, Lexan®, shatterproof and glass windows
- Stainless steel tags are available options
- Silicone fill
- Certificates of Conformance, Origin and Calibration available
- Please see these options on Table 8 of "Ordering Bimetal Thermometers".
- Other options are available. Please consult factory

Union Lock Nut

The WIKA union lock nut provides a simple and inexpensive means to mount WIKA bimetal thermometers with 1/2" NPT so that the dial is oriented for proper viewing. For more information, please consult factory. To order, specify part number **TA600-0111**.

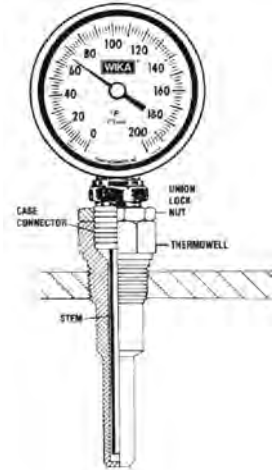

Maximum or Minimum Indicating Pointer

This option allows operator to view what the highest or lowest temperature has been in the process. High vibration environments are not recommended.



Mechanical Temperature > Digital Thermometers > TI.80 / TI.82

Type TI.80 / TI.82

WIKA's solar-powered digital thermometers are ideal for power utilities, petrochemical and quality control applications, where exact readings are required. TI.80 and TI.82 offer easy-to-read digital temperature in single-degree increments in either Fahrenheit or Celsius scales. TI.80 has a center back mount, while the TI.82 has an adjustable angle, hermetically-sealed case.



Standard Features

- Case:** 304 SS
- Stem:** 304 SS, lengths from 1" to 24"
- Window:** Glass standard, acrylic available
- Connection:** 1/2" NPT, others available
- Sensor System:** Ceramic thermistor requiring lighting of only 35 LUX to operate the 3-volt solar cell. The circuitry offers a fast 15-second update time and accuracy to within 1% of scale. A patented safety circuit prevents false readings
- Accuracy:** ± 1% of full range span

Type	TI.80							
Connection	1/2" NPT Back							
Dial Size	3"							
Stem Length	2 1/2"	4"	6"	9"	12"	15"	18"	24"
-50/300 °F	80025D2G4	80040D2G4	80060D2G4	80090D2G4	80120D2G4	80150D2G4	80180D2G4	80240D2G4
-50/150°C	80025D1G4	80040D1G4	80060D1G4	80090D1G4	80120D1G4	80150D1G4	80180D1G4	80240D1G4

Type	TI.82							
Connection	1/2" NPT Just-Right Adjustable Angle							
Dial Size	3"							
Stem Length	2 1/2"	4"	6"	9"	12"	15"	18"	24"
-50/300 °F	82025D2G4	82040D2G4	82060D2G4	82090D2G4	82120D2G4	82150D2G4	82180D2G4	82240D2G4
-50/150°C	82025D1G4	82040D1G4	82060D1G4	82090D1G4	82120D1G4	82150D1G4	82180D1G4	82240D1G4

Options		
	Code	Description
Connection	0	Plain
	2	1/4" NPT
	3	3/8" NPT (TI.80 only)
Window	A	Acrylic
Accessories	ST	Sharp tip
	SS	316 SS wetted parts
Stem	HD	3/8" dia. stem w/ 2 1/2" L x 1/4" dia. tip
	HS	3/8" dia. stem w/ 2 1/2" L x 1/4" dia. sharp tip

Stock items shown in blue print.

Mechanical Temperature > Twin-Temp Thermometers > TT.30 / TT.32 / TT.50 / TT.52

Type TT.30 / TT.32 / TT.50 / TT.52

The Twin-Temp thermometer combines the convenience, simplicity and self-powered actuation of a bimetal thermometer and data acquisition capabilities of a thermocouple or RTD electrical output. With standards traceable to the NIST, the Twin-Temp offers simplified calibration for ISO 9001 compliance and other statistical process control requirements. It is ideal in applications requiring quick and easy readability at the point of process, while still affording a means of electronic data acquisition and digital panel remote read-out. The Twin-Temp puts two temperature sensors to work at one location.



Standard Features

Case and Bezel:	304 SS	Over Range:	Maximum exposure 500°F
Case:	All angle or back connected	Thermocouple:	Type K grounded junction thermocouple standard Types J, E and T available
Dial Size:	3" or 5"	RTD:	100-Ohm thin film platinum DIN Curve (.00385 Ohm/ Ohm/°C), 3 wire standard
Process Connection:	½" NPT standard	Accuracy:	± 1% of full range span
External Reset:	Slotted hex head, fully gasketed	Warranty:	1 year
Window:	Glass, fully gasketed	Wiring:	Twin-Temp (RTD): red-terminal 1, green-terminal 2, black-terminal 3 Twin-Temp (T/C): negative-red always, positive-colored (depends on t/c type)
Hermetic Seal:	Per ASME B40.3	Note:	Silicone fill not available
Stem:	304 SS, TIG welded at tip and case connector to prevent leakage. ¼" diameter standard, lengths available from 2½" to 48"		

Mechanical Temperature > Twin-Temp Thermometers > Ordering Twin-Temp Thermometers

Ordering Twin-Temp Thermometers

HOW TO ORDER:

Select the appropriate codes and combine to complete thermometer part number.

Sample Part Number: 30 060 D 0 01 G 4 R1 A R

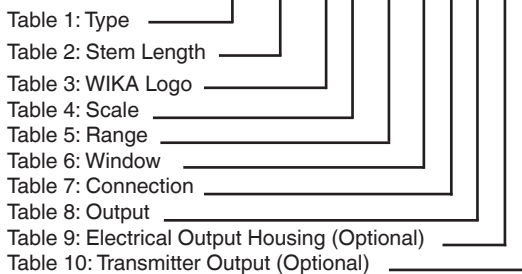

Table 1 - Basic Type

Code	Description
30	3" Back connected (with reset)
32	3" All angle (with reset)
50	5" Back connected (with reset)
52	5" All angle (with reset)

Table 2 - Stem Length

(Pick stem length from either thermocouple or RTD table)

Code	Description
XXX	Length in inches with one decimal place (XX.X) RTD available only in 4" to 48" (040-480) stem length. Thermocouple available 2½" to 48" (025-480).

Thermocouples - Types J, K, E, T Grounded Thermocouple Output (consult factory for ungrounded)

Stem Length	2.5	4	6	9	12	15	18	24	30	36	42	48
Code	025	040	060	090	120	150	180	240	300	360	420	480

Note: Thermocouple junction is welded to tip of stem

or

100 Ohm RTD Output

Stem Length	2.5	4	6	9	12	15	18	24	30	36	42	48
Code	025	040	060	090	120	150	180	240	300	360	420	480

Note: RTD is placed in stem above bimetal helix (requires minimum 3½" insertion)

TWIN-TEMP THERMOMETERS

Mechanical Temperature > Twin-Temp Thermometers > Ordering Twin-Temp Thermometers

Code	Description
D	WIKA standard
X	Special

Code	Description
0	Dual scale °F & °C
1	Single scale °C
2	Single scale °F

Code	Dual Scale		
	Dual Scale °F & °C	Single Scale °C	Single Scale °F
02*	-40/120°F & -40/50°C	-50/50°C	-40/120°F
03*	25/125°F & -5/50°C	0/50°C	25/125°F
04*	0/140°F & -20/60°C	-20/60°C	0/140°F
5	0/200°F & -15/90°C	0/100°C	0/200°F
6	0/250°F & -20/120°C	-20/120°C	0/250°F
7	20/240°F & -5/115°C	-10/110°C	20/240°F
8	50/300°F & 10/150°C	0/150°C	50/300°F
9	50/400°F & 10/200°C	0/200°C	50/400°F
10	50/500°F & 10/260°C	0/250°C	50/500°F
16	50/550°F & 10/260°C	10/290°C	50/550°F

* Not available with 2 1/2" stem

Code	Description
G	Plain glass
A	Acrylic
L	Lexan®
S	Shatterproof

Code	Description
2	1/4" NPT
4	1/2" NPT

Choose an electrical output configuration from either the left column only or right column only

Code	Description
TJ	Thermocouple output, Type J (female plug)
TK	Thermocouple output, Type K (female plug)
TE	Thermocouple output, Type E (female plug)
TT	Thermocouple output, Type T (female plug)
RA	100 Ohm RTD output, 3-wire (terminal block)

Code	Description
J1	Thermocouple output, Type J
K1	Thermocouple output, Type K
E1	Thermocouple output, Type E
T1	Thermocouple output, Type T
R1	100 Ohm RTD output, 3-wire

Code	Description
X	None
J	Straight barrel weather proof housing (7/8-20 UNEF) & plug
K	Straight barrel weather proof housing (7/8-20 UNEF) & plug
E	Straight barrel weather proof housing (7/8-20 UNEF) & plug
T	Straight barrel weather proof housing (7/8-20 UNEF) & plug
R	Straight barrel weather proof housing (7/8-20 UNEF)

Code	Description
X	None
A	*Std aluminum head enclosure
H	*Exp. proof head

Code	Description
X	None (mandatory on all non-transmitter types, must use this code "X" for all TJ/TK/TE/TT/RA from Table 8)

Code	Description
X	None (mandatory on all non-transmitter types; must use this code "X" for all TJ/TE/TT/RA from Table 8)
T	^{1,3} 4-20mA transmitter for all Thermocouple output
R	^{2,3} 4-20mA transmitter for all "R1" RTD output (from Table 8)
B	³ Terminal block (for field wiring termination, when transmitter no used)

Twin-Temp Configurations

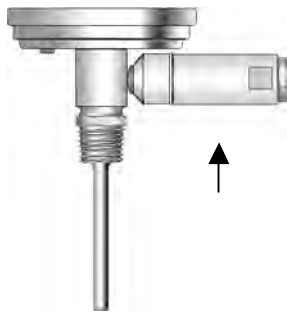

1. Weatherproof Housing and Plug

$\frac{7}{8}$ -20 UNEF threaded barrel with bushing and compression nut provide environmental protection to thermocouple / RTD connection. (Order code J,K,E,T or R from Table 9)



2. 1/2" NPT Electrical Connection with Lead Wire

Available in thermocouple or RTD. This allows site installation using other enclosures or piping systems. (Order code J1, K1, E1, T1 or R1 from Table 8)

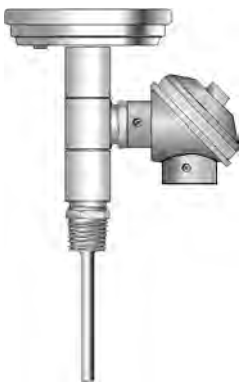

3. Enclosure Head

A protective enclosure threads onto the optional 1/2" NPT electrical connection. The housing protects electrical connections from the environment. Houses a 4-20 mA transmitter or terminal block. Aluminum housing is standard. (Order code A from Table 9)

4. Terminal Block

Provides a connection point for the thermocouple or RTD. Mounts to thermocouple head with two screws. Requires lead-wire output connection (order code J1/K1/E1/T1/R1 from Table 8) and aluminum head enclosure. (Order code A from Table 9)



5. T-12 Thermocouple or T-24- RTD, 4-20 mA Transmitter

Provides a clean 4-20 mA signal to control room, data acquisition equipment, panel readout, etc. Requires lead-wire output connection (order code J1/K1/E1/T1/R1 from Table 8) and aluminum head enclosure (order code from Table 9).

Spare Parts	
Description	Part Number
Std aluminum head	102-02
Terminal block	2246228
Weather-proof housing	TA6S0-0608
¹ When order separate of a Twin-Temp, range must be specified	

Twin-Temp Configurations

**Type TT.30
w/enclosure head**

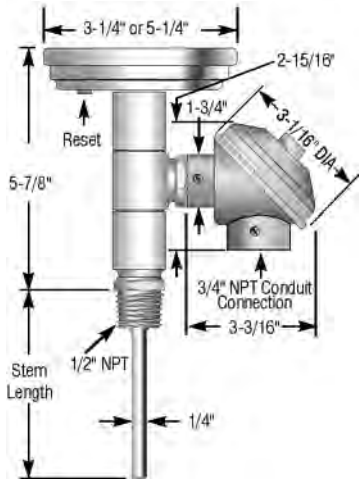

**Type TT.52
w/thermocouple
connection**

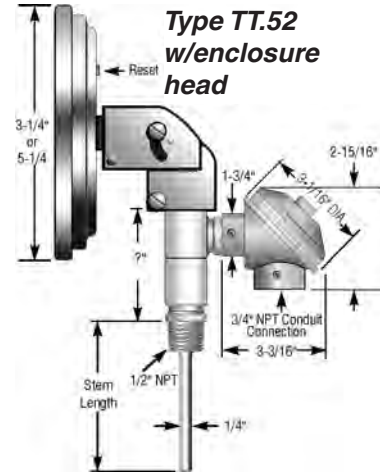
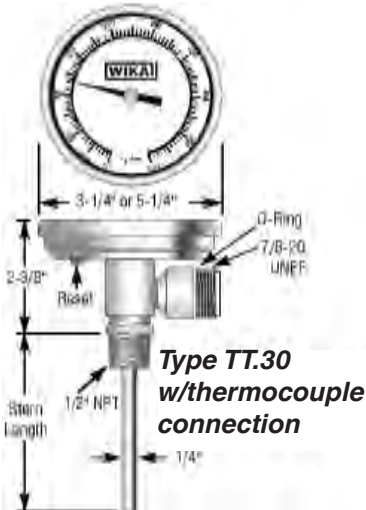
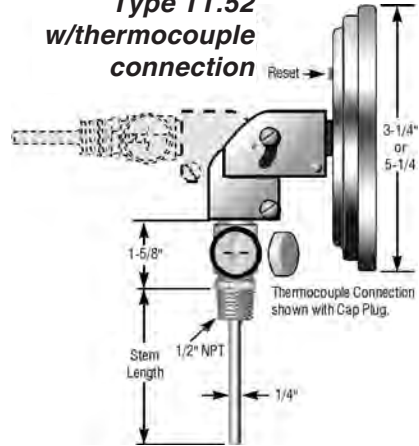

**Type TT.30
w/thermocouple Plug-in**

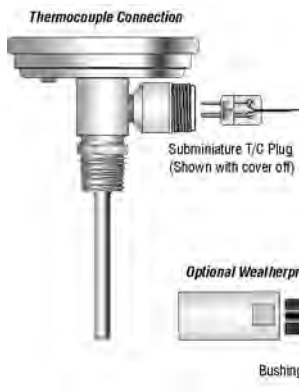

**Type TT.30
w/RTD terminal block**



MECHANICAL TEMPERATURE

TWIN-TEMP SOLAR THERMOMETERS

Mechanical Temperature > Twin-Temp Solar Thermometers > TT.80, TT.82

Type TT.80, TT.82

This unique thermometer has the convenience of a LCD digital output and the data acquisition capabilities of a thermocouple or RTD electrical output in one process location.



Standard Features

Case and Bezel:	304 SS	RTD:	100-Ohm thin film platinum DIN Curve (.00385 Ohm/Ohm/°C), 3 wire standard
Case:	All angle or back connected	Accuracy:	± 1% of full range span
Dial Size:	3"	Warranty:	1 year
Process Connection:	½" NPT standard	Wiring:	Twin-Temp (RTD): red-terminal 1, green-terminal 2, black-terminal 3 Twin-Temp (T/C): negative-red always, positive-colored (depends on t/c type)
Window:	Glass, fully gasketed	Note:	Silicone fill not available
Hermetic Seal:	Per ASME B40.3		
Stem:	304 SS, TIG welded at tip and case connector to prevent leakage. ¼" diameter standard, lengths available from 2½" to 24".		
Thermocouple:	Type K grounded junction thermocouple standard. Types J, E, T available		

Mechanical Temperature > Twin-Temp Solar Thermometers > Ordering Twin-Temp Solar Thermometers

Ordering Twin-Temp Solar Thermometers

HOW TO ORDER:

Select the appropriate codes and combine to complete thermometer part number.

Sample Part Number: 80 040 D 6 G 4 R1 A R

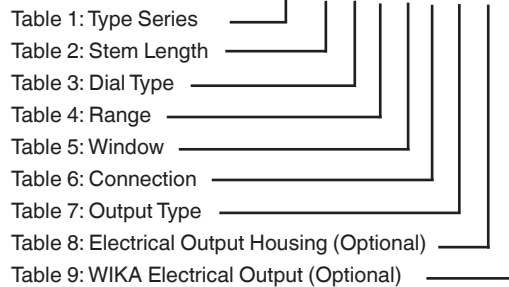

Table 1 - Basic Type	
Code	Description
80	3" Back connected
82	3" All angle

Table 2 - Stem Length	
Code	Description
025	2.5"
040	4"
060	6"
090	9"
120	12"
150	15"
180	18"
240	24"

Table 3 - Dial Type	
Code	Description
D	WIKA standard

Table 4 - Ranges	
Code	Description
1	-50/300 °F
2	-50/150 °C

Table 5 - Window Material	
Code	Description
G	Plain glass
A	Acrylic

Table 6 - Process Connection	
Code	Description
4	1/2" NPT

Table 7 - Electrical Output	
Code	Description
J1	Thermocouple output, type J
K1	Thermocouple output, type K
E1	Thermocouple output, type E
T1	Thermocouple output, type T
R1	100 Ohm RTD output, 3-wire

Table 8 - Electrical Output Housing Options	
Code	Description
X	None
A	Std Aluminum head enclosure

Table 9 - Transmitter Output	
Code	Description
X	None
T	^{1,3} 4-20mA transmitter for all thermocouple output
R	^{2,3} 4-20mA transmitter for all "R1" RTD output (from Table 8)
B	³ Terminal block (for field wiring termination, when transmitter not used)

¹ only compatible with codes J1/K1/E1/T1
² only compatible with code R1
³ must use code A Table 8 for enclosure

Gas Actuated Thermometers Operating and Installation

Gas actuated thermometers fall within “Class IV, gas-filled with absorbent” definition. They use a thermal system filled with gas and an absorbent (such as activated granular carbon) in the bulb. This technology allows for a significantly reduced bulb size. WIKA gas actuated thermometers offer extremely high accuracy, low ambient error and extreme over-range capability. With the same small bulb diameter throughout the offered ranges, the WIKA thermometer can be installed in most existing piping and tank applications.

WIKA gas actuated thermometers provide the solution to mercury-free requirements in food processing, refrigeration or other mercury-sensitive environments. A variety of case types, sizes and materials provides a custom made instrument for each application in ranges between -320° Fahrenheit and +1200° Fahrenheit or equivalent Celsius. Dual reading scales (F & C) are standard.

WIKA gas actuated dial thermometers are available as direct reading or remote reading with stainless steel bulbs and armored capillary. WIKA extends a one-year warranty against defects in material and workmanship on standard gas actuated dial thermometers.

Installation Guidelines: While WIKA gas actuated dial thermometers are highly accurate and rugged instruments, there are some guidelines that should be followed in their application and installation. Consideration must be given to the measured medium. Is it corrosive, abrasive, turbulent or under pressure? Can the sensing bulb be placed to give an accurate indication of the temperature?

The sensing bulb should be placed in a non-turbulent area of piping or ducting and as close the center of the flow as possible. In tanks, it should be placed in an area of the tank that will provide a good average of the temperature of the fluid contained. The bulb should be protected from corrosive or abrasive media and excessively high pressures. The usual method of protection is the use of a thermowell.

When a remote reading thermometer is installed, consideration must be given to the location of the bulb, the dial indicator and the routing of the capillary. The capillary must be located where it will not be damaged by workers or equipment used in future maintenance. Remember that the capillary CANNOT be cut to facilitate installation or relocation.

For Installation and Use of WIKA Filled System Dial Thermometers

General: Before installing a thermometer, consideration should be given to temperature, humidity, vibration, shock and other climatic and ambient conditions of the service application. Bulbs may be installed in thermowells or directly into the medium for temperature measurement. The filled system of the thermometer is a sealed unit and must remain sealed. The connecting tubing of remote units should be kept coiled to avoid sharp bends or kinks. Connecting tubing must not be cut. Thermometers can be rendered inaccurate during shipment despite care taken in packaging. To insure conformance to the accuracy to which the thermometer was manufactured, it should be checked before use.

Installation Procedure: The bulb should be located in the process at the point that will provide the temperature indication that is most representative of the process temperature. Circulation of the medium around the bulb is necessary for optimum response time and accuracy. For direct reading thermometers, use wrench flats when provided to install the thermometer. For remote reading thermometers – do not twist, kink, strain or cut the connecting tube. After the case has been mounted, uncoil and stretch out the connecting tubing, placing the bulb at its intended location. After installing the bulb, fasten the connecting tubing to a wall or other support to prevent damage. Position the connecting tubing to avoid extreme temperature. Since the connecting tubing length cannot be altered, any excess should be coiled on a 3" minimum radius and supported near the case.

Gas actuated thermometers have the following options and accessories:
 Flush Mounting Ring: Adapts the phenolic case for flush panel mounting.
 Windows: Optional acrylic or shatterproof glass available.

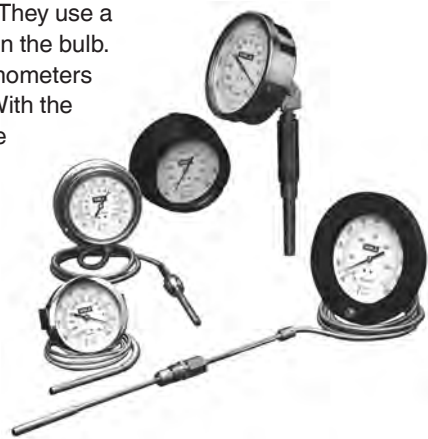

Gas Actuated Thermal Systems

The WIKA gas actuated dial thermometer systems are available in several bulb and material configurations. The application should be the determining factor in deciding both the type and material of the thermal system. For use in corrosive or otherwise more demanding installations, WIKA offers a 316 SS bulb and capillary. The stainless steel system is protected with stainless steel spring armor or an optional stainless steel interlocking armor. **It should be noted that the unions on these systems DO NOT provide a pressure seal.** For pressure seals, always use in conjunction with a thermowell.

For installations requiring a pressure seal between the process and the atmosphere, a thermowell should be used. The bendable extension with a sliding union allows for variable insertion depths to place properly the active portion of the sensing bulb in the process for maximum accuracy. Aluminum duct flanges are available for threading union fitted bulbs into duct work to provide temperature indication of ducted air or gases.

Thermal Systems

Code No.	Bulb Type	Bulb Material	Capillary Material	Capillary Protection
0	Just-Rite	316 SS	N/A	N/A
1	Plain	316 SS	316 SS	Stainless steel spring armor**
8	1/2" NPSM Sliding Union	316 SS	316 SS	Stainless steel spring armor**

**Stainless steel interlocking armor is available and must be used on systems longer than 40 feet.

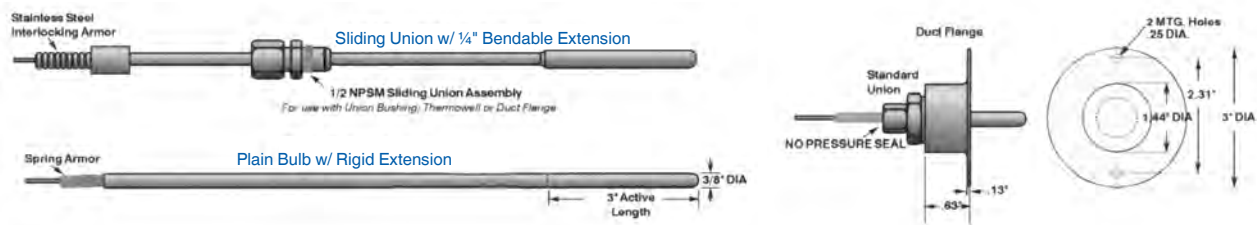

Bulbs available on WIKA gas actuated dial thermometers have 3/8" diameters to allow for installation in most existing piping and tanks. As the bulb is the temperature sensing element of the system, it must be placed where the most accurate temperature reading can be obtained. In piping, this is usually the center of the flow in an area of least turbulence. In tanks, this is an area that will represent a good average of the fluid temperature - usually close to the center of the tank. Available materials, lengths and insertion depths for standard bulbs are listed in the accompanying chart.

Bulbs (All bulbs with threaded connections are 1/2" NPT)

Code No	Bulb Type	Bulb Material	Bulb Length	Extension Length	Insertion - U Thermowell Standard	Dimension Thermowell Lag Extension
1	Plain w/extension	316 SS	3"	12"	2 1/2" - 10 1/2"	-
4	Just-Rite	316 SS	4"	-	2 1/2"	-
6	Just-Rite	316 SS	6"	-	4 1/2"	2 1/2"
9	Just-Rite	316 SS	9"	-	7 1/2"	4 1/2"
X	Just-Rite	316 SS	12"	-	10 1/2"	6 1/2"
7	Sliding union	316 SS	3"	12"	2 1/2" - 10 1/2"	2 1/2" - 7 1/2"
8	Sliding union	316 SS	3"	18"	2 1/2" - 16 1/2"	2 1/2" - 13 1/2"

*3" active length

GAS ACTUATED THERMOMETERS

Mechanical Temperature > Gas Actuated Thermometers > TI.R45, TI.R60

Type TI.R45, TI.R60

WIKA gas actuated remote reading dial thermometers are manufactured in three wall-mounted case styles: the cast aluminum back flange case with a 4½" dial size, the phenolic/GRP turret case (also with a 4½" dial size) and the stainless steel back flange case available in 4½" and 6" dial sizes. All may be specified with back or lower connected capillaries.



Standard Features

Accuracy: ±1% of full range span
Over Range: 50% of span above top of range or 1300°F, which ever is lower
Cases: Drawn stainless steel, aluminum and Phenolic/GRP; for stem, surface or panel mount
Sizes: 4½", 6"
Mounting Connections: Lower or back on remote reading thermometers; adjustable angle on Just Rite
Bulb: 3/8" dia. x 3" active length standard in stainless steel; plain, sliding union

Capillary: 316 SS with stainless steel spring armor, or 316 SS with stainless steel interlocking armor. 99' maximum
Dials: White coated aluminum with black marking
Pointer: Adjustable, balanced, aluminum with matte black finish
Ambient Error: 0.25% at midscale of span per 25° F change in ambient temp

Case Styles: Wall mount-manufactured in 3 wall-mounted case styles: cast aluminum back flange case with 4½" dial size, the phenolic/GRP turret case with 4½" dial size, and stainless steel back flange case in 4½" and 6" dial sizes; may be specified with back or lower-connected capillaries.

Just-Rite's standard bulb/stem thermal system is available in 4", 6" and 9" lengths; only 3" of the tip is active. Panel mount WIKA gas actuated remote reading dial thermometers accommodate most panel mounting requirements. Stainless steel U clamp cases are available in 4½" and 6". Aluminum front flange cases offer 4½" and 6" dial sizes. A stainless steel semi-flush front flange case is available in 4½" and 6" dial sizes. All panel mount thermometers are back connected. Turret phenolic case is available in 4½". Just-Rite is available in 4½" and 6".

Adjustable angle-flangeless, stainless steel case with bayonet bezel and 360° rotation. Stainless steel bulb can be rotated 180° to either side of the vertical axis of the stem to allow mounting from the top, bottom or either side of an installation. Union fitted bulb can be threaded directly into a process connection or into a thermowell or duct flange.

Mechanical Temperature > Gas Actuated Thermometers > Ordering Gas Actuated Thermometers

Ordering Gas Actuated Thermometers

HOW TO ORDER:

Select the appropriate codes and combine to complete thermometer part number.

Table 1 - Basic Type

Code	Description
R45	4½" Case
R60	6" Case

Table 2 - Case Type & Material

Code	Description	Material	Dial Size
K	Back flange, bayonet ring	SS	4½", 6"
B	Back flange, bayonet ring	Aluminum	4½", 6"
E	Turret, threaded ring	Phenolic	4½"
F	Front flange, hinged ring	Aluminum	4½", 6"
S	Semi-flush front flange, bayonet ring	SS	4½", 6"
U	U-clamp, bayonet ring	SS	4½" 6"
*V	Just-Rite, adjustable angle	SS	4½" 6"

* Capillary is not available. Fixed stem length only as specified in Table 6.

Sample Part Number: R45 E L 3 8 7 10 004 00 WI

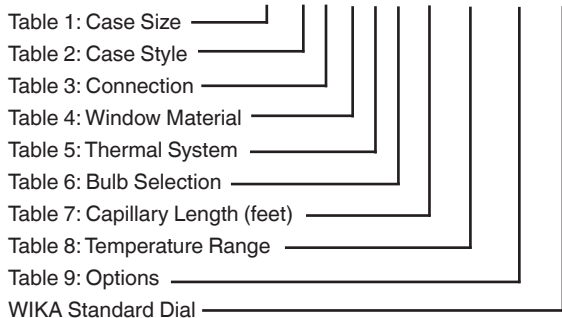

GAS ACTUATED THERMOMETERS

Mechanical Temperature > Gas Actuated Thermometers > Ordering Gas Actuated Thermometers

Code	Description	Case Size	Case Type
B	Back connection	4½", 6"	All
L	Lower connection	4½", 6"	4½" (K, B, E); 6" (K only)
*A	Adjustable angle	4½", 6"	V only

* Capillary is not available. Fixed stem length only as specified in Table 6.

Code	Description	Case Size	Case Type
3	Acrylic	4½"	B, E
4	Glass	4½", 6"	All
5	Shatter-proof glass	4½"	E, K, E, U, V

Code	Bulb Type	Bulb Material	Capillary Material	Capillary Protection
0	Adjustable angle ½" NPT	316 SS	N/A	**N/A
1	Plain	316 SS	316 SS	Spring armor*
8	Sliding union ½" NPT	316 SS	316 SS	Spring armor*

* For systems up to 40 ft.; Spiral interlock required on all systems over 40 ft. (see "SI" options, Table 9)
 ** Capillary is not available; fixed stem length only as indicated in Table 6.

Special Table 5 & 6 Note:
 The only possible thermal system/bulb combinations are as follows:
Plain Bulb: (11)
Adjustable Angle: (04), (06), (09), (0X)
Sliding Union: (87), (88)

Code	Description	To fit Thermowells with:	
		OA Length	Thermowell Insertion
Adjustable Angle Code 0, Table 5			
4	3/8" Dia. x 3" length (active), total 4"	4¼"	U = 2½"
6	3/8" Dia. x 3" length (active), total 6"	6¼"	U = 4½"
9	3/8" Dia. x 3" length (active), total 9"	9¼"	U = 7½"
X	3/8" Dia. x 3" length (active), total 12"	12¼"	U = 10½"
Plain Bulb - Remote Code 1, Table 5			
1	3/8" Dia. x 3" length (active) + 10" rigid extension		
Sliding Union (½" NPSM) Bulb w/Bendable Ext. Code 8, Table 5			
7	3/8" Dia. x 3" length (active) w/ 12" bendable extension	3 to 12"	U = 2½" to 10½"
8	3/8" Dia. x 3" length (active) w/ 18" bendable extension	3 to 18"	U = 2½" to 16½"

Note: Gas-actuated thermometers use standard process type 3/8" bore thermowells, if required. Order separately.

Code	Description
05	5 feet
10	10 feet
20	20 feet
30	30 feet
40	40 feet
*50	50 feet
*80	80 feet
XX	Adjustable angle case

* Requires "SI" option, see Table 9

Note:
 Capillary can be configured to any whole foot, 99' and below. I.E. - 08 = 8' capillary

Code	Dual Scale °F & °C	
*001	-320/100°F	-200/40°C
002	-120/120°F	-80/50°C
003	0/120°F	-20/50°C
004	0/160°F	-20/70°C
005	-40/180°F	-40/80°C
006	20/240°F	-10/115°C
007	0/300°F	-20/150°C
008	50/550°F	10/280°C
009	50/750°F	0/400°C
**010	400/1,200°F	200/650°C
11	50/400°F	0/200°C

* Requires "LT" option, See Table 9
 ** Requires "HT" option, See Table 9

Note:
 Ranges marked with an asterisk(*) indicated in Table 8 reference Table 9 and require additional cost as indicated.

Code	Description	Case Size	Case Type
00	Without accessories	All	All
FR	Flush mounting ring	4½"	E
*LT	Low temperature (Cryogenic -320°F)	All	All
**HT	High temperature (1200°F)	All	All
***SI	316 SS interlocking armor	All	All
DM	Dampened movement	All	All

* Requires Temperature Range Code "001", See Table 8
 ** Requires Temperature Range Code "010", See Table 8
 *** Required for all systems over 40 feet

Code	Description
WI	WIKA
BL	Blank

Mechanical Temperature > Gas Actuated Thermometers > Temperature Switch Gauge Operating and Installation

Gas Actuated Thermometers Temperature Switch Gauge Operating and Installation

Operation: WIKA's TI.TSG60 temperature switch gauge is a patented technology that offers the best accuracy and least ambient error in remote temperature technology. Our direct drive edge-welded Bourdon tube offers a linear 180° dial arc while maintaining positive operation of micro switches with a 1½% accuracy full scale with better than ½% repeatability. Most important is the extremely low ambient error due to the NiSpan Bourdon tube and carbon-filled molecular sieve gas actuated patented technology. The cam adjustable switches offer little resistance to the powerful direct drive system offering consistent switch action with low repeatability error.

Our dual system SCADA version offers dual independent outputs with a failsafe redundant system. Total independence offers accuracy of remote electronics plus the reliability of the local mechanical dial readout all within one unit. The SCADA system comes fully calibrated and requires no field calibration.

Switching: Up to four filled adjustable switches are available with standard ratings of 10 AMP @ 125/250 VAC, non-inductive; 5 AMP @ 120 VAC, inductive; ½ AMP @ 125 VDC, non-inductive; ¼ AMP @ 250 VDC, non-inductive. The differential is 3% of the range. Switches are fully adjustable within the full range of the instrument. Switches can be set within 2° C of each other.

Mounting / Installation: The TI.TSG60 temperature switch gauge is ideal for general industrial installations. Switches can be adjusted from the front of the unit without having to shut down or remove the instrument from the process.

Adjustment of the Set Points: The TI.TSG60 has up to four fully adjustable set points adjustable from the front of the unit. The set point indicators are easily adjusted and then locked in place with the following procedure:

1. Unscrew and remove the front bezel and lens counter-clockwise, as it is shipped from the factory hand tightened.
2. Using a small straight screwdriver, loosen the Set Point indicator and, using two fingers, position the indicator to the desired Set Point, and re-tighten the Set Point indicator.
3. Replace the bezel and lens and, using a strap wrench, rotate the bezel and lens clockwise ¾" beyond hand tight to fully engage the waterproof gasket. Do not over tighten.

Max. Hand Setting: The TI.TSG60 is available with a maximum registering hand that will indicate the highest temperature the unit records by staying at that point. To re-set the max, hand turn the knob counter-clockwise until it rests against the pointer.

Mechanical Temperature > Gas Actuated Thermometers > TI.TSG60

Type TI.TSG60

WIKA's TI.TSG60 offers users an unprecedented combination of industrial strength performance with unmatched precision. This 6" gas actuated thermometer is accurate to within 1½% of scale and can tolerate up to 50% over range temperatures. Sealed inside the rugged stainless steel case are up to four single pole, double throw 10 amp switches for enabling a variety of switching actions. The thermal system is stainless steel and filled with inert nitrogen making the TI.TSG60 ideal for steel and paper mills, refineries, petrochemical, and food and pharmaceutical plants.



Standard Features

Case and Bezel:	304 SS, 6.25" diameter	Over Range:	50% up to 500°F, except 10% on 0 - 120°C and 0 - 250°F
Case Style:	Bottom connected back flange	Capillary:	Stainless steel with stainless steel interlocking armor; up to 99'
Process Conn:	¾" x 3" 316 SS bulb with 12" or 18" bendable extension, and ½" NPT one-time compression fitting	Switch Rating:	10 amp @ 125/250 VAC, non-inductive; 5 amp @ 120 VAC, inductive; ½ amp @ 125 VDC, non-inductive; ¼ amp @ 250 VDC, non-inductive
Window:	Lexan®		
Range:	11 standard ranges available. See "How to Order"		

Ordering Temperature Switch Gauges

HOW TO ORDER:

Select the appropriate codes and combine to complete thermometer part number.

Sample Part Number: TSG60 03 2 A2 X7 05 SG WI

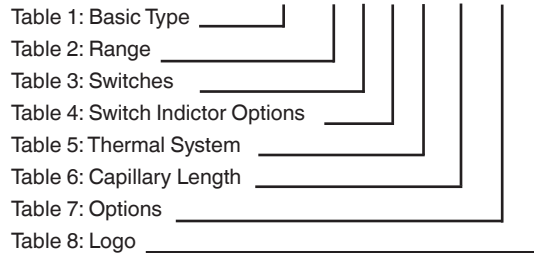

Table 1 - Basic Type	
Code	Description
T1.TSG60	6" back flange temperature switch gauge with conxall connector harness 5" wire length

Table 2 - Range			
Code	Description	Code	Description
01*	-450/50°F	07	0/1000°F
02*	-320/200°F	08	-20/120°
03	0/250°F	09	-20/160°C
04	-50/350°F	10	-20/180°C
05	50/550°F	11	-20/200°C
06	50/750°F		

Table 3 - Switches	
Code	Description
1	One adjustable switch (amphenol connector)
2	Two adjustable switches (amphenol connector)
3	Three adjustable switches (amphenol connector)
4	Four adjustable switches (amphenol connector)

Table 4 - Standard Switch Indicator Options	
Code	Description
A1	Center switch indicator (1 switch)
A2	Right & left switch indicators (2 switches)
A3*	Right, left & center switch indicators (3 switches)
A4*	Right, left, right, left switch indicator (4 switches)

* For adjacent switches, right and left side indicators will allow for closest proximity of switch settings

Table 5 - Thermal System	
Code	Description
X7	3/8" x 3" bulb w/12" bendable extension, 1/2" NPT one-time adjustable compression fitting
X8	3/8" x 3" bulb w/18" bendable extension, 1/2" NPT one-time adjustable compression fitting

Table 6 - Capillary Length	
Code	Description
XX	Capillary length in feet

Table 7 - Options	
Code	Description
SG	Safety glass
EX	Explosion-proof

Table 8 - Logo	
Code	Description
EH WI	WIKA
EH BL	Blank

VAPOR ACTUATED THERMOMETERS

Mechanical Temperature > Vapor Actuated Thermometers > TI.V20 / TI.V25 / TI.V35 / TI.V45

Type TI.V20 / TI.V25 / TI.V35 / TI.V45

WIKA's vapor actuated thermometers are highly accurate and provide remote reading. They are available in U-clamp, front flange or back flange case configurations. WIKAI's vapor actuated thermometers are well suited for refrigeration, solar heating and water treatment applications.



Standard Features

Case:	Stainless steel
Accuracy:	±1 scale division
Movement:	Heavy duty brass, rotary type
Ring:	Snap-in O-ring
Window:	Glass or polycarbonate
Pointer:	Aluminum, adjustable, black finish
Dial:	Aluminum, white background, black graduations
Bourdon Tube:	Phosphor bronze, soldered to socket and tip
Process Connection:	Plain, union or thermowell
Bulb:	Copper or stainless steel
Capillary:	Copper- plain or with braid armor; stainless steel- plain; stainless steel or with stainless steel interlocking armor

Mechanical Temperature > Vapor Actuated Thermometers > Ordering Vapor Actuated Thermometers

Ordering Vapor Actuated Thermometers

HOW TO ORDER:

Select the appropriate codes and combine to complete thermometer part number.

Sample Model No: V25 UB3 5331 05 04 WI

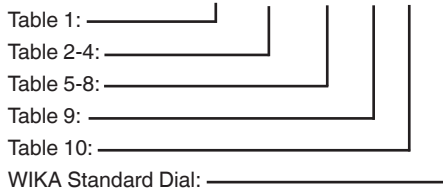

Table 1 - Basic Type	
Code	Description
V20	2"
V25	2½"
V35	3½"
V45	4½"

Table 2 - Case Style				
Code	Case Type	Material	Case Size	Case Conn.
F	Front flange	SS	2", 2½"	B
U	U-clamp	SS	2", 2½"	B
Q	U-clamp	SS	3½"	B
B	Back flange	SS	3½", 4½"	B, L
R	Front flange, semi-flush	SS	3½", 4½"	B



VAPOR ACTUATED THERMOMETERS

Mechanical Temperature > Vapor Actuated Thermometers > Ordering Vapor Actuated Thermometers

Ordering Vapor Actuated Thermometers

Code	Description	Case Size	Type
B	Back connection	All	All
L	Lower connection	3½", 4½"	B

Code	Description	Case Size	Case Type
3	Lexan® snap-in lens	All	All
4	Glass lens w/ SS ring	2", 2½"	F, U
5	Glass lens w/ chrome-plated brass ring	3½"	All
7	Glass lens w/ rubber ring	4½"	B, R
8	Glass lens w/ crimped SS ring, water-proof	2", 2½"	U
9	Lexan® threaded lens	2" 2½"	F, U, Q

Code	Bulb Type	Bulb Mat'l	Capillary Mat'l	Cap Protection
1	Plain	Copper	Copper	None
2	Plain	Copper	Copper	Cu. braid
3	Plain	316 SS	316 SS	None
4	Union	Copper	Copper	None
5	Union	Copper	Copper	Cu. braid
8	Union	316 SS	316 SS	Interlock armor
9	Union	316 SS	316 SS	None

Note: Available combinations for Thermal System (Table 5) and Bulb Selection (Table 6):

Plain: 12, 13, 14, 15, 16, 22, 23, 24, 25, 26, 32, 33, 34, 35, 36

Union: 41, 42, 43, 44, 45, 51, 52, 53, 54, 55, 81, 82, 83, 84, 85, 91, 92, 93, 94, 95

Also must consider Capillary Length (Table 9).

Use Codes below for Plain Bulb for Non-threaded Process Connection (Codes 1-3 in Table 5)			
Code	Diameter	Length	Max. Sys. Length
2	3/8"	3.4"	25 feet
3	3/8"	4.9"	50 feet
4	3/8"	7.9"	99 feet
5	3/8"	9.4"	99 feet
6	3/8"	2.5"	5 feet
Use Codes below for Union Bulb for Threaded Process Connection (Codes 4-9 in Table 5)			
1	7/16"	2.5"	10 Feet
2	7/16"	3.4"	25 feet
3 ¹	7/16"	5.4"	50 feet
4	7/16"	7.4"	99 feet
5	7/16"	9.4"	99 feet

¹ Required for lagging extension thermowell, see Table 7

Code	Description
1	Union ½" NPT
2	Union ¾" NPT
3	Thermowell ½" NPT
4	Thermowell ¾" NPT
5*	Thermowell ½" NPT with 2" lag ext.
6*	Thermowell ¾" NPT with 2" lag ext.
7	Aluminum air duct flange (union only)
9	Plain bulb (always select "plain bulb" - table 5; codes 1, 2, 3)

* Lag only available with #3 bulb

Code	Description
0	None (plain bulb only, always select for Codes 1-3 in Table 5)
1	Brass
2	304 SS
3	316 SS
5	Aluminum (air duct flange only)

Code	Description
05	5 feet
10	10 feet
15	15 feet
20	20 feet
30	30 feet
50	50 feet
80	80 feet

Note:
Capillary can be configured to any whole foot, 99' and below. I.E. - 08 = 8' capillary

Code	Description
01	-40/60 °F&°C
02	-40/110 °F&°C
03	-20/100 °F&°C
04	0/150 °F&°C
05	0/180 °F&°C
06	20/220 °F&°C
07	40/240 °F&°C
08	30/300 °F&°C
09	100/350 °F&°C
11	150/450 °F&°C

Code	Description
WI	WIKAI
BL	Blank

INDUSTRIAL GLASS THERMOMETERS

Mechanical Temperature > Industrial Glass Thermometers > TI.61102 / TI.61104, TI.62102 / TI.62104

Type TI.61102 / TI.61104, TI.62102 / TI.62104

WIKA's 6" industrial glass thermometers are ideal for process piping, HVAC/R applications, diesel engines, compressors and brine lines. This series of thermometers is manufactured in straight and back connected configurations, and come with a standard dual threaded brass socket with both 1/2" and 3/4" NPT connections.

Standard Features

- Case:** V-shaped gray GE Valox®; wide angle construction
- Glass Front:** Protective glass cover retained within outer edges of case. Spring pressure created by V-scale secures glass against case and prevents rattling. Cover plate completes assembly.
- Tube and Scale:** Blue spirit fill liquid (non-mercury fill). V-shaped scale designed with extra large black numbers. Crosslocked scale holding device prevents loosening or shifting of scale and removes holes and screws that interfere with scale markings or numerals.
- Stem and Socket Assembly:** Brass stem ensures fast response to temperature changes. The standard socket is made of brass and dual threaded for 1/2" and 3/4" NPT.
- Accuracy:** ±1% of full scale range



Mechanical Temperature > Industrial Glass Thermometers > Ordering Industrial Glass Thermometers

Ordering TI.61102 / TI.61104, TI.62102 / TI.62104 Thermometers

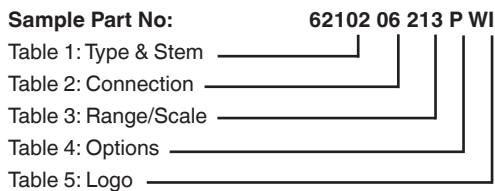

HOW TO ORDER:

Select the appropriate codes and combine to complete thermometer part number.

ABBREVIATIONS

N/C - there is no charge for this option.

Code	Description	Stem Length
61102	Straight with 2" stem	1.31"
62102	Back with 2" stem	1.31"
61104	Straight with 4" stem	3.31"
62104	Back with 4" stem	3.31"

Code	Description
00	None - swivel nut connection
06	1/2" and 3/4" brass well

°F Only			°C Only			Dual Scale °F & °C		
Code	°F	Scale Div.	Code	°C	Scale Div.	Code	°F & °C	Scale Div.
201	-40/110	2	115	-40/45	1	001	-40/110 (-45/45 C)	2/1
203	20/120	2	102	-5/50	1	003	20/120 (0/50 C)	2/1
213	20/180	2	118	0/110	2	013	20/180 (0/80 C)	2/2
207	30/240	2	108	0/150	2	007	30/240 (5/110 C)	2/2
208	30/300	5	106	10/200	5	008	30/300 (0/150 C)	5/2
209	50/400	5	n/a	n/a	n/a	009	50/400 (10/200 C)	5/5

Code	Description
P	Plastic window

Code	Description
WI	WIKA

Type	Description
6110206	Straight form with U dimension 1.31"
6210206	Back form with U dimension 1.31"
6110406	Straight form with U dimension 3.31"
6210406	Back form with U dimension 3.31"

Type	Description
6110200	Straight form with U dimension 1.31"
6210200	Back form with U dimension 1.31"
6110400	Straight form with U dimension 3.31"
6210400	Back form with U dimension 3.31"

Mechanical Temperature > Solar Industrial Glass Thermometer > TI.D01

Type TI.D01

WIKA's TI.D01 solar industrial thermometer offers fast, accurate and easy-to-read temperature indications. This thermometer features a totally adjustable case to permit viewing at any angle, and its bulb and socket are completely interchangeable with standard industrial glass thermometers. The solar industrial thermometer is switchable between Fahrenheit and Celsius, and offers a sensing range of -50 to 300°F and -50 to 150°C, resolved in tenths of a degree, with accuracy to within $\pm 1\%$ of reading.



Standard Features

Range:	-50/300°F (-50/150°C)
Accuracy:	$\pm 1\%$ of reading or 1°, whichever is greater
Resolution:	1/10° between -19.9/199.9°F (-28/93°C)
Lux Rating:	10 lux (one foot candle)
Update:	10 seconds
Ambient Operating	
Temperature:	-30/140°F (-35/60°C)
Humidity:	100% maximum
Ambient Temperature	
Error:	None
Case:	High-impact ABS
Display:	7/16" LCD digits, wide ambient temperature range
Sensor:	Glass passivated thermistor

Stock items shown in blue print.

Factory Stock	
Part Number	Description
D010300WI	3½" stem, no thermowell
D010600WI	6" stem, no thermowell
D010301WI	3½" stem, with thermowell
D010601WI	6" stem, with thermowell

Non-Stocked Items	
Part Number	Description
D010304WI	3½" stem, with reversible flange air duct stem
D010604WI	6" stem, with reversible flange air duct stem
D010901WI	9" stem with thermowell

Accessories	
Part Number	Description
TA600-0216	Clear plastic protective cover

Mechanical Temperature > Industrial Glass Thermometers > TI.701/TI.901

Type TI.701 / TI.901

WIKA's TI.701 (7") and TI.901 (9") industrial glass thermometers offer quick, easy-to-read temperature measurement for tough applications. Glass/mineral reinforced GE Valox® housings and spring mounted windows contribute to impact, shock and vibration resistance. WIKA industrial glass thermometers are the ideal choice for process piping, HVAC/R applications, diesel engines and compressors.

Standard Features

Case:	V-shaped case parts are molded of rugged GE Valox® 735 polyester, finished in textured black. Heavy glass window is spring-mounted to prevent rattles.	Adjustable Joint:	Matching GE Valox® joint completely encloses capillary for thermal system protection.
Stem:	To ensure sensitivity, bulb chambers are precision ground aluminum, tapered for a close-tolerance metal-to-metal contact with matching tapered socket. Graphite is used as a conductor between bulb chamber and glass tube.	Tube and Capillary:	Blue spirit-fill liquid (non-mercury fill) standard; magnifying lens tube is silicone shock-mounted to increase service life. Guaranteed accurate to within $\pm 1\%$ of scale range.
Locking Device:	Independent adjustable case lock-nut and angle adjusting screw provide 360° positioning of case and stem.	Scale:	Permanently baked-on, bold black graduations are printed on white-coated aluminum. No mounting screws obscure scale. Scale adjusts through locking device at top of instrument.
		Accuracy:	$\pm 1\%$ of full scale range



Ordering TI.701 / TI.901 Thermometers

Sample Part No: 901 03 01 004 P WI

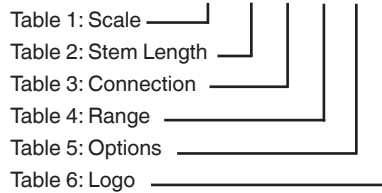

HOW TO ORDER:

Select the appropriate codes and combine to complete thermometer part number.

Table 1 - Scale	
Code	Description
701	7" scale, swivel-nut connection
901	9" scale, swivel-nut connection
702	7" scale, perforated stem for duct flange
902	9" scale, perforated stem for duct flange

Table 2 - Stem Length	
Code	Description
03	3½" stem
06	6" stem
09	9" stem
12	12" stem

Table 3 - Connection	
Code	Description
00	Swivel-nut connection (no thermowell)
01	¾" NPT brass, thermowell
02	¾" NPT brass with lagging extension
03	¾" NPT brass union hub
04	Duct flange, reversible with or without lagging ext

Table 4 - Single Scale Ranges					
Code	°F	°F Scale Div.	Code	°C	°C Scale Div.
201	-40/110	2	101	-40/50	1
204	0/120	1	104	0/100	1
205	0/160	2	105	0/160	2
206	30/180	2			
207	30/240	2			
208	30/300	5			
*210	50/550	5			

* Requires aluminum case

Table 4 - Dual Scale Ranges				
Code	°F	°C	°F Scale Div.	°C Scale Div.
001	-40/110	-40/43	2	1
004	0/120	-17/49	1	1
005	0/160	-15/70	2	1
006	30/180	0/80	2	1
007	30/240	0/115	2	1
008	30/300	0/150	5	2
*010	50/550	10/290	5	5

* Requires aluminum case

Table 5 - Options	
Code	Description
P	7" plastic window
P	9" plastic window
A*	7" or 9" aluminum case*

* required above 300°F / 160°C

Table 6 - Logo	
Code	Description
WI	WIKA

Factory Stock	
Part Number	Description
9010300004WI	9" scale, 3½" stem, 0/120°F & °C
9010300007WI	9" scale, 3½" stem, 30/240°F & °C
9010300204WI	9" scale, 3½" stem, 0/120°F
9010300205WI	9" scale, 3½" stem, 0/160°F
9010300206WI	9" scale, 3½" stem, 30/180°F
9010300207WI	9" scale, 3½" stem, 30/240°F
9010301204WI	9" scale, 3½" stem, with ¾" NPT brass thermowell 0/120°F
9010301207WI	9" scale, 3½" stem, with ¾" NPT brass thermowell 30/240°F
9010300005WI	9" scale, 3½" stem, 0/160°F & °C
9010600204WI	9" scale, 6" stem, 0/120°F
9010600208WI	9" scale, 6" stem, 30/300°F
9010601208WI	9" scale, 6" stem, with ¾" NPT brass thermowell 30/300°F

Stock items shown in blue print.



INDUSTRIAL GLASS THERMOMETERS

Mechanical Temperature > Industrial Glass Thermometers > Ordering Industrial Glass Thermometers

Ordering TI.701 / TI.901 Thermometers

Custom (Non-Stock) Industrial Glass Thermometers

7" & 9" Scale Industrial Thermometers with Swivel-nut Connection (no Thermowell)

Type	Connection	Range	Logo	Description
70103	00	See chart	WI	7" scale, 3½" stem
70106	00	See chart	WI	7" scale, 6" stem
70109	00	See chart	WI	7" scale, 9" stem
70112	00	See chart	WI	7" scale, 12" stem
90103	00	See chart	WI	9" scale, 3½" stem
90106	00	See chart	WI	9" scale, 6" stem
90109	00	See chart	WI	9" scale, 9" stem
90112	00	See chart	WI	9" scale, 12" stem

T-85 Thermowell Conversion Kit

Part Number	Description
TA800-0T85	This conversion kit offers an easy, inexpensive way to install a WIKA bimetal thermometer in a glass industrial thermometer's thermowell. For more information, please consult factory.

7" & 9" Scale Industrial Thermometers with ¾" NPT Brass Thermowell, with or without Lagging Extension

Type	Connection	Range	Logo	Description
70103	01	See chart	WI	7" scale, 3½" stem with thermowell
70106	01 or 02	See chart	WI	7" scale, 6" stem with thermowell (01) or well with lagging extension (02)
70109	01 or 02	See chart	WI	7" scale, 9" stem with thermowell (01) or well with lagging extension (02)
70112	01 or 02	See chart	WI	7" scale, 12" stem with thermowell (01) or well with lagging extension (02)
90103	01	See chart	WI	9" scale, 3½" stem with thermowell
90106	01 or 02	See chart	WI	9" scale, 6" stem with thermowell (01) or well with lagging extension (02)
90109	01 or 02	See chart	WI	9" scale, 9" stem with thermowell (01) or well with lagging extension (02)
90112	01 or 02	See chart	WI	9" scale, 12" stem with thermowell (01) or well with lagging extension (02)

7" & 9" Scale Industrial Thermometers Complete with Flange

Type	Connection	Range	Logo	Description
70203	04	See chart	WI	7" scale, 3½" stem with reversible duct flange (with or without lagging ext.)
70206	04	See chart	WI	7" scale, 6" stem with reversible duct flange (with or without lagging ext.)
70209	04	See chart	WI	7" scale, 9" stem with reversible duct flange (with or without lagging ext.)
70212	04	See chart	WI	7" scale, 12" stem with reversible duct flange (with or without lagging ext.)
90203	04	See chart	WI	9" scale, 3½" stem with reversible duct flange (with or without lagging ext.)
90206	04	See chart	WI	9" scale, 6" stem with reversible duct flange (with or without lagging ext.)
90209	04	See chart	WI	9" scale, 9" stem with reversible duct flange (with or without lagging ext.)
90212	04	See chart	WI	9" scale, 12" stem with reversible duct flange (with or without lagging ext.)

Single Scale Ranges

Code	°F	°F Scale Div.	Code	°C	°C Scale Div.
201	-40/110	2	101	-40/50	1
204	0/120	1	104	0/100	1
205	0/160	2	105	0/160	2
206	30/180	2			
207	30/240	2			
208	30/300	5			
*210	50/550	5			

* Requires aluminum case

Dual Scale Ranges

Code	°F	°C	°F Scale Div.	°C Scale Div.
001	-40/110	-40/43	2	1
004	0/120	-17/49	1	1
005	0/160	-15/70	2	1
006	30/180	0/80	2	1
007	30/240	0/115	2	1
008	30/300	0/150	5	2
*010	50/550	10/290	5	5

* Requires aluminum case

MECHANICAL TEMPERATURE

Type TW.FL / TW10 Flanged, TW.TH / TW15 Threaded, TW.SW / TW20 Socket Weld, TW.WI / TW25 Weld-in, TW.SC / TW30 Sanitary

Thermowells for temperature instruments are recommended for all process systems where pressure, velocity or viscous, abrasive and corrosive materials are present individually or in combination. A properly selected thermowell protects the temperature instrument from possible damage resulting from these process variables. Furthermore, a thermowell permits removal of the temperature instrument for replacement, repair or testing without affecting the process media or the system.



Standard Features

Process Connections:	Threaded, flanged, sanitary, socket, weld, weld-in
Instrument Connection:	½" NPSM standard (National Pipe Standard Mechanical); a straight pipe thread for mechanical joints)
Shank Configurations:	Reduced, straight, tapered
Bore Diameter:	.260", .385"
Materials:	Brass, AISI 304, AISI 316
Surface Finish:	Brass: 60-100 Ra; AISI 304 & AISI 316: 60-100 Ra sanitary (AISI 304 & AISI 316): 16-20 Ra

Thermowell Terminology

Process Connection: External means to connect thermowell to process piping system. Wells can be threaded, bolted (to matching flange), clamped or welded in place.

Instrument Connection: Internal threads to connect temperature instrument to thermowell.

U Dimension: Length of well inserted into the piping system. Measured from the base of the process connection to the end tip of well.

T Dimension: Also called lagging extension. Extends length between the instrument and process connections to accommodate vessel or piping insulation. Standard length is 3" (2" for a well with a 2½" U dimension).

S Dimension: Instrument insertion length into well.

Bore Diameter: Dimension of internal bore to match the diameter of the instrument stem/bulb inserted into the well. The .260" and .385" bore sizes fit instrument stem/bulb diameters of ¼" and ⅜" respectively. Bore length equals S dimension.

Root Diameter: Diameter of well shank below process connection. This dimension varies with process connection and/or shank design.

Tip Diameter: Diameter of well shank at the end tip of well. This dimension may vary with process connection and/or shank design.

Reduced Shank: Also called reduced tip. The shank O.D. is reduced over the last 2½" of the U dimension from the standard root diameter to a ½" O.D. The stepped shank is available with a .260" bore size only.

Straight Shank: Shank O.D. is the same from the root diameter to the tip diameter. The straight shank is generally used with a .385" bore size but a .260" bore size is available.

Tapered Shank: Shank O.D. is gradually reduced from the root diameter to the tip diameter. Available with a .260" or .385" bore size. The tapered shank is recommended for heavy duty applications characterized by high vibration, pressure, temperature and/or velocity.

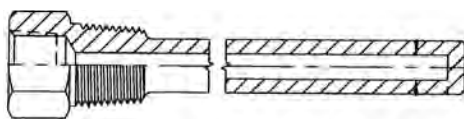

Threaded Straight Configuration

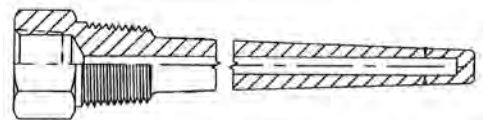

Threaded Tapered Configuration

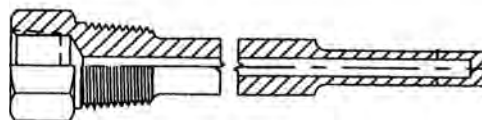

Threaded Reduced (Stepped) Configuration

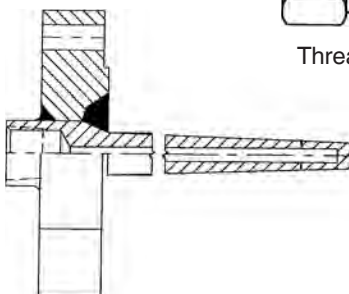

Flanged Tapered Configuration

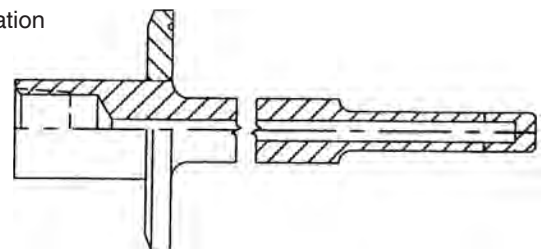

Sanitary Reduced Configuration

Thermowells For Bimetal & Gas Actuated Thermometers

CODING EXAMPLES									
Type	Part Number	Process Connection	Bore/Type	Lag	Shank Design	U Dim.	Material	Rating	Facing
Threaded	75-TH2R-045-CC	¾" NPT	.260/threaded	None	Stepped	4½"	304SS		
Threaded	75-TH2LT-055-SS-T5	¾" NPT	.260/threaded	5" Lag	Tapered shank	5½"	316SS		
Flanged	15-FL2T-070-SS-150RF	1½" flanged	.260/flanged	None	Tapered shank	7"	316SS	150#	RF
Sanitary	10-SC2R-045-SS	1" sanitary	.260/sanitary	None	Stepped shank	4½"	316SS		
Socket weld	75-SW2R-045-CC	¾" NPT	.260/skt weld	None	Stepped	4½"	304SS		

WIKA THERMOWELL PRODUCT CODING EXPLANATION								
Process Connection	Type / Bore Dia.	Lag	Shank Design	Standard U Dimensions (No Lag)		For Stem Length	Standard Material	Cap & Chain
				Type FL	All Other Types			
50 = ½"	TH2 = Threaded/.260	Blank=No lag	R = Reduced	N/A	*015 = 1½"	2½"	BR=Brass	2= ST.ST.
75 = ¾"	TH3 = Threaded/.385	L=Standard lag	S = Straight	020 = 2"	025 = 2½"	4"	CC=304 SS	
10 = 1"	FL2 = Flanged/.260		T = Tapered	040 = 4"	045 = 4½"	6"	SS=316 SS	
12 = 1¼"	FL3 = Flanged/.385			070 = 7"	075 = 7½"	9"	CS=Carbon steel	
15 = 1½"	SC2 = Sanitary/.260			100 = 10"	105 = 10½"	12"	MO=Monel®	
20 = 2"	SC3 = Sanitary/.385			130 = 13"	135 = 13½"	15"	CP=Carp.20	
	SW2 = Socket weld/.260			160 = 16"	165 = 16½"	18"	IN=Inconel® 600	
	SW3 = Socket weld/.385			220 = 22"	225 = 22½"	24"	NI=Nickel	
				Standard U with lag (T)			HB=Hastelloy® B	
				Type FL	All Other Types		HC=Hastelloy® C	
				020 = 2"	025 = 2½"		TA=Tantalum	
				(T=2")	(T=2")	6"	TI=Titanium	
				040 = 4"	045 = 4½"		TC=Teflon® coated	
				(T=3")	(T=3")	9"	Other material, consult factory for pricing.	
				070 = 7"	075 = 7.½"			
				(T=3")	(T=3")	12"		
				100 = 10"	105 = 10½"			
				(T=3")	(T=3")	15"		
				130 = 13"	135 = 13½"			
				(T=3")	(T=3")	18"		
				190 = 19"	195 = 19½"			
				(T=3")	(T=3")	24"		

For Flanged Well, Specify Rating & Facing	
Rating	Facing
150#	
300#	FF=Flat Face flange
600#	RF=Raised Face flange
900#	RTJ=Ring Joint flange
1500#	

*Note: For ½" NPT process connection the "U" dimension becomes 1" to accommodate ½" NPSM female thread. Order as *010", i.e. 50TH2R010CC.

Threaded Thermowell Factory Stock				
Part Number				
75TH2R015BR	75TH2R015CC	75TH2R015SS	75TH2R025BR	75TH2R025CC
75TH2R025SS	75TH2LR025SS	75TH2R045CC	75TH2R045SS	75TH2R045BR
75TH2R045CC	75TH2LR045SS	75TH2R075SS	50TH2R010CC	50TH2R010SS
50TH2R025BR	50TH2R025CC	50TH2R025SS		

Stock items shown in blue print.

Threaded Configuration

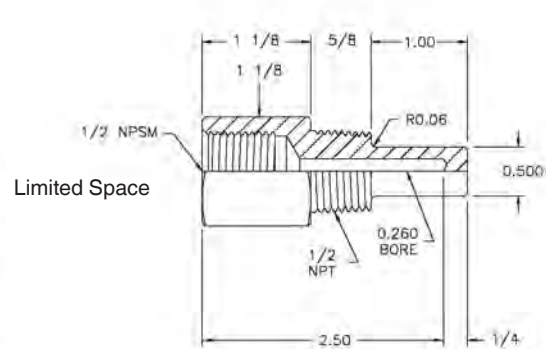
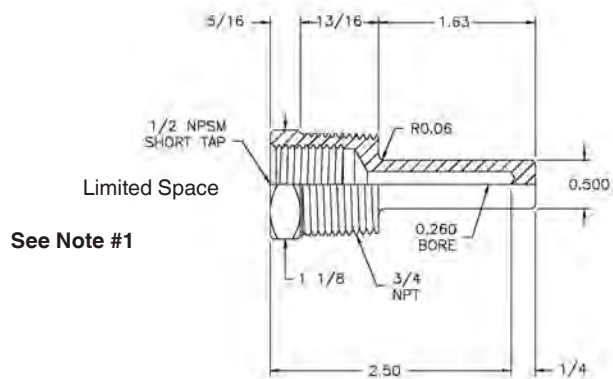
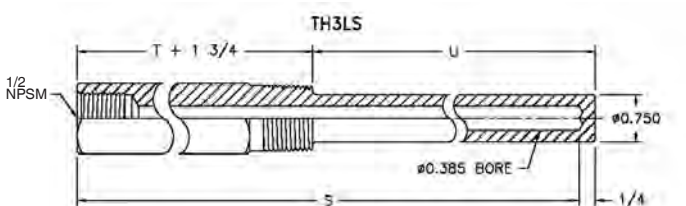
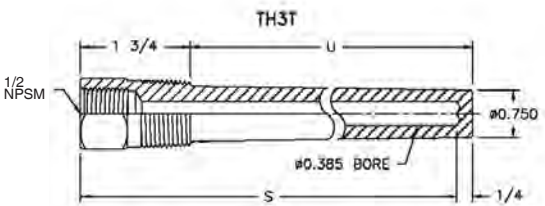
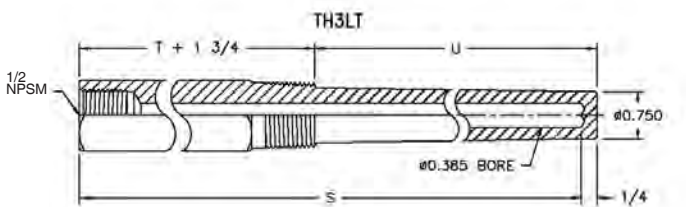
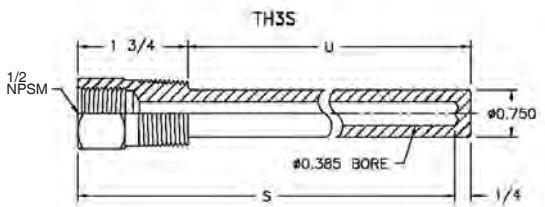
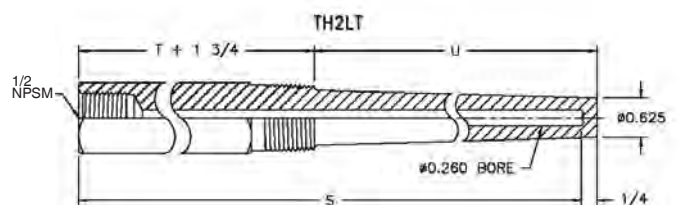
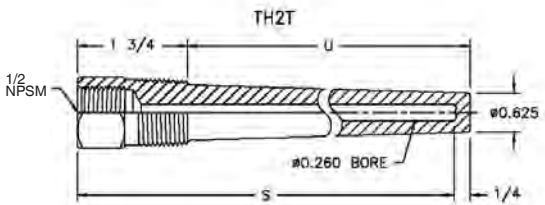
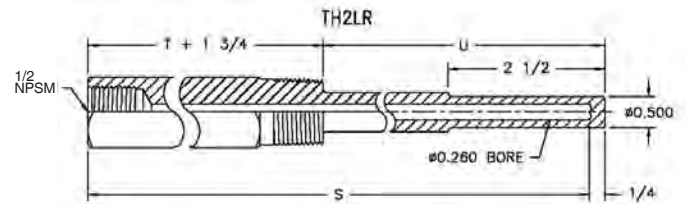
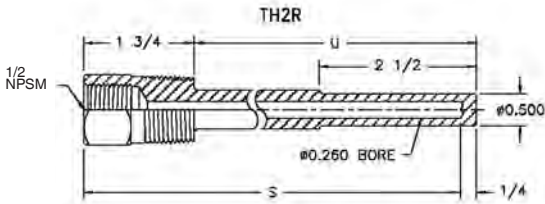

Notes:

1. Normal U dimension on limited space well is 1⁵/₈" for 3/4" NPT and 1" NPT process connection.
(For 1/2" NPT process connection, U dimension becomes 1" to accommodate 1/2" NPSM female thread).
Order as "010", i.e. 50TH2R010CC.

Mechanical Temperature > Thermowells > Flanged Configuration

Flanged Configuration

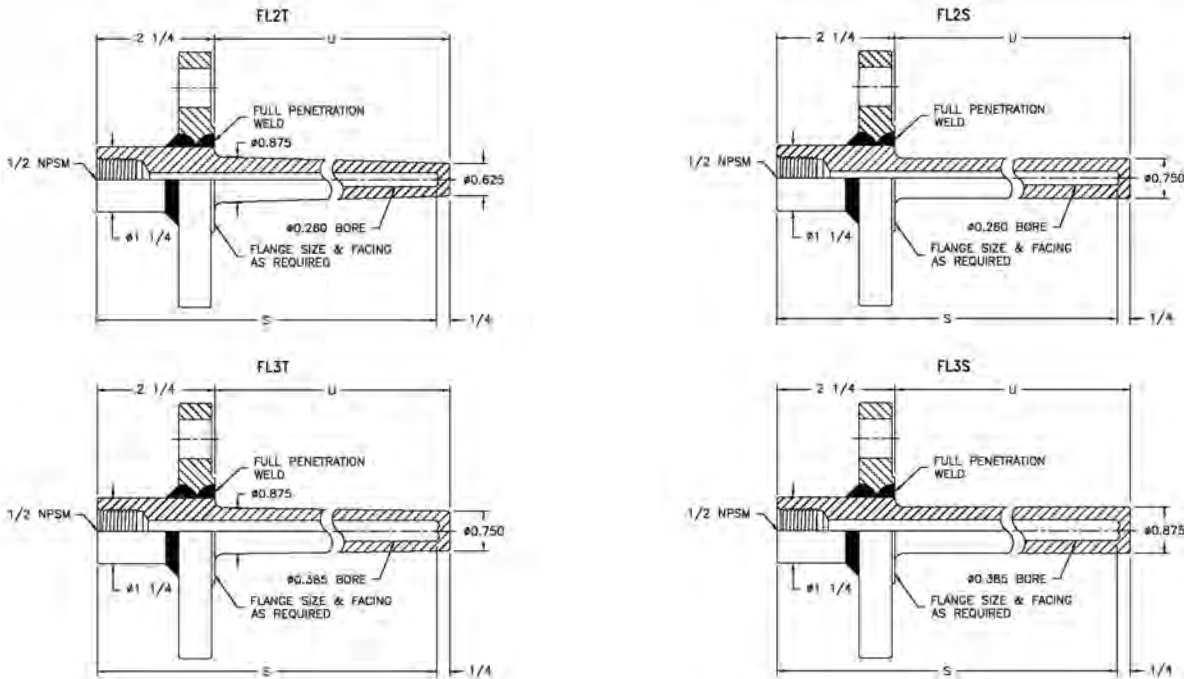

Flange Rating	Minimum Head Lengths					
	Flange Size					
	1"	1-1/2"	2"	2-1/2"	3"	4"
150#	2.25" (57.2)	2.25" (57.2)	2.25" (57.2)	2.25" (57.2)	2.25" (57.2)	2.25" (57.2)
300#	2.25" (57.2)	2.25" (57.2)	2.25" (57.2)	2.25" (57.2)	3.25" (82.6)	3.25" (82.6)
400#	2.25" (57.2)	2.25" (57.2)	3.25" (82.6)	3.25" (82.6)	3.25" (82.6)	3.25" (82.6)
600#	2.25" (57.2)	2.25" (57.2)	3.25" (82.6)	3.25" (82.6)	3.25" (82.6)	3.25" (82.6)
900#	3.25" (82.6)	3.25" (82.6)	3.25" (82.6)	3.25" (82.6)	3.25" (82.6)	3.25" (82.6)
1500#	3.25" (82.6)	3.25" (82.6)	3.25" (82.6)	3.25" (82.6)	3.25" (82.6)	3.25" (82.6)
2500#	3.25" (82.6)	3.25" (82.6)	4.25" (108.0)	4.25" (108.0)	4.25" (108.0)	4.25" (108.0)

HOW TO ORDER

Specify flange size, rating and facing, thermowell U dim., bore dia. and material.
 Raised face flange supplied as standard ANSI serrated. Specify 125 RMS smooth face if required at no extra charge.

Mechanical Temperature > Thermowells > Socket Weld Configuration

Socket Weld Configuration

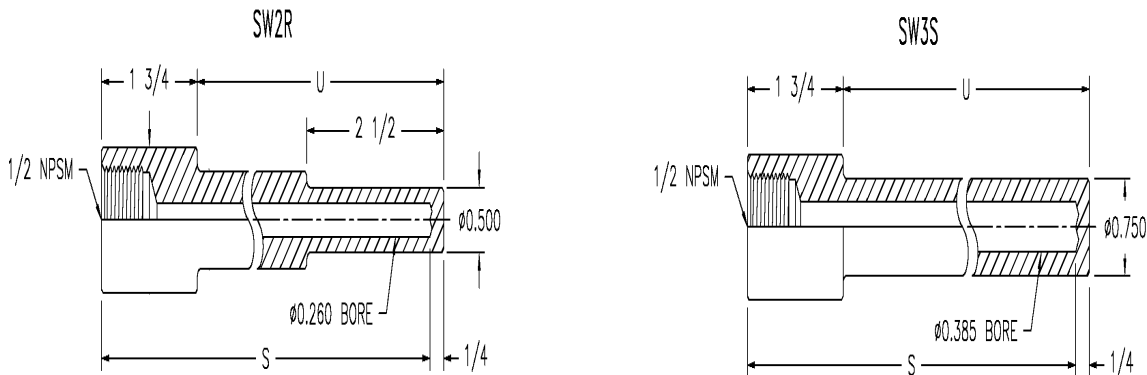

Sanitary Configuration

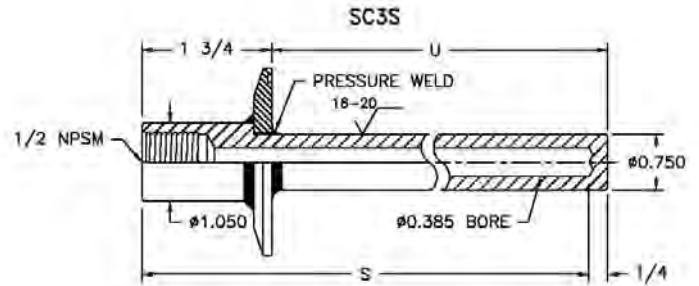
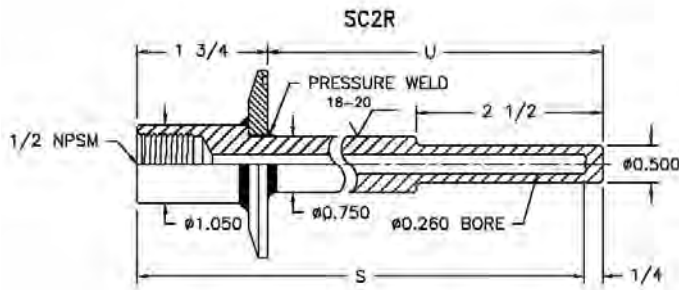

Notes:

1. Meets USDA and 3A Sanitary Standard 74-03
2. Available with 1", 1½", 2" and 3" solid end caps
3. Special designs available upon request
4. Standard finish AISI 304 and AISI 316, 16-20 Ra

Note: Minimum stem length is 4"

Sanitary Thermowells - Stepped or Straight Shank

Type SC2 (.260 Bore) & SC3 (.385) bore, stepped or straight shank, with or without lag

Size	Type	No Lag U Dim	With Lag		S Dim
			U Dim	T Dim	
1" or 1½"	SC2R	2½	--	--	4
	SC2LR	4½	2½"	2	6
	SC3S				
	SC3LS	7½	4½"	3	9

Size	Type	No Lag U Dim	With Lag		S Dim
			U Dim	T Dim	
2"	SC2R	2½	--	--	4
	SC2LR	4½	2½"	2	6
	SC3S				
	SC3LS	7½	4½"	3	9

Sanitary Thermowells - Tapered Shank

Type SC2 (.260 Bore) & SC3 (.385) bore, tapered shank, with or without lag

Size	Type	No Lag U Dim	With Lag		S Dim
			U Dim	T Dim	
1" or 1½"	SC2T	2½	--	--	4
	SC2LT	4½	2½"	2	6
	SC3T				
	SC3LT	7½	4½"	3	9

Accessories

Description	Part Number	Code
SS cap & chain		Code 2
Stamping on well		--
5.3 oz. tube heat transfer compound	2256045	--
Paper tag		--

Size	Type	No Lag U Dim	With Lag		S Dim
			U Dim	T Dim	
2"	SC2T	2½	--	--	4
	SC2LT	4½	2½"	2	6
	SC3T				
	SC3LT	7½	4½"	3	9

Note: Sanitary thermowells are polished to 16-20 Ra per 3A Sanitary Standards

Thermowells for Industrial Glass Thermometers

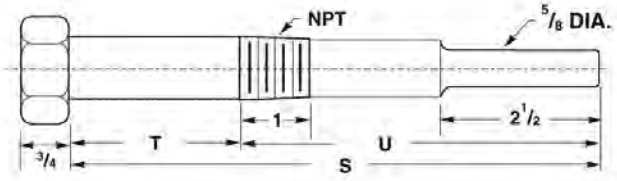
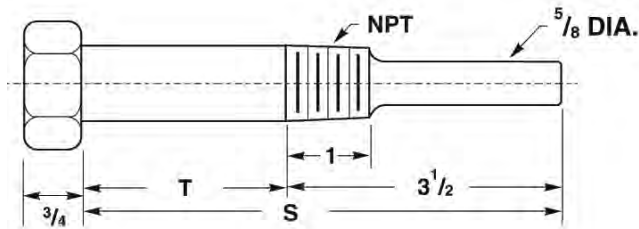
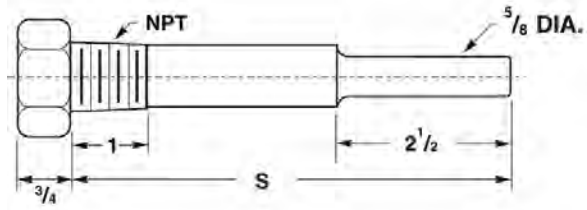
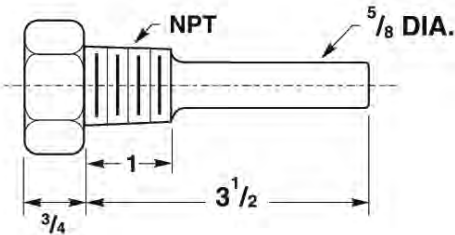

Thermowell Product Coding Explanation

Process Connection	Type / Bore Dia.	Lag	Shank Design	Nominal Bulb Length	For Stem Length	Standard Material	Cap & Chain
75 = 3/4" 10 = 1"	TH5 = Threaded / 0.435 min. dia.	Blank = No lag L=Standard lag	R = Stepped	035 = 3 1/2" 060 = 6" 090 = 9"	3 1/2" 6" 9"	BR=Brass CC=304 SS SS = 316 SS	1=Brass 2=St. Steel

WIKA Industrial Thermowell Coding Explanation

Type TH5 stepped shank, with or without lag

Size	Type	No lag	with lag		"S"
			U Dim.	T Dim	
3/4" or 1"	TH5R TH5LR	2-9/16"	-----	-----	3 1/2"
		5-1/16"	2-9/16"	2 1/2"	6"
		8-1/16"	5-1/16"	3"	9"
		11-1/16"	8-1/16"	3"	12"

Factory Stock

Threaded Thermowell for Industrial Glass Thermometers

Part Number
75TH5R035BR
75TH5R060BR
75TH5LR035BR

Accessories > Gauge Cocks > 910.10

Type 910.10

WIKA gauge cocks provide an economical method for isolating the instrument from the process and for throttling line pressure. They also act as an adjustable flow orifice and are rated to 200 psi. WIKA's 910.10 gauge cocks are intended for use on light-duty air applications.



Standard Features

Pressure Rating:	Brass: 200 psi
Operating Temperature:	Media: max. 140°F (+93°C); min. 0°F (-18°C)
Valve Body:	Brass
Handle:	Brass, available with "T" or lever type handle
Stem Seals:	None
Standard Threaded Connection Size:	¼" NPT or ½" NPT M & F

Type		910.10			
Pressure Gauge Cocks					
Material	Lever Type	Connection	Press. Rating	Max Temp Rating	Part Number
Brass	"T" handle	¼" X ¼" NPT-female	200 psi	140°F	4339631
Brass	"T" handle	¼" NPT-female X ¼" NPT-male	200 psi	140°F	4339640
Brass	Lever handle	¼" X ¼" NPT-female	200 psi	140°F	4339658
Brass	Lever handle	½" X ½" NPT-female	200 psi	140°F	4339674
Brass	Lever handle	¼" NPT-female X ¼" NPT-male with union connection	200 psi	140°F	4339666

Notes: In applications where process media leakage may result in possible personal injury or property damage, gauge cocks should not be specified as they contain no packing gland and leakage may result. For tight shut-off and prevention of leakage, use of a WIKA Needle Valve is required.

Stock items shown in **blue print**.

Accessories > Needle Valves > 910.11

Type 910.11

Type 910.11 needle valves can be used to isolate a pressure instrument from the application. For general applications, the hard seat version is the industry standard. Soft seat versions are ideal for gaseous media where a bubble tight seal is required. Both inline and angle versions are available.



Standard Features - Carbon Steel Model

- Pressure Rating:** Hard seat -10,000 psi @ 200°F max.
Soft seat - 6,000 psi @ 200°F max.
 - Valve Body:** 12L14 carbon steel
 - Bonnet:** 12L14 carbon steel
 - Valve Stem:** 316 SS
 - Handle:** 12L14 carbon steel
 - Handle Bolt:** Carbon steel
 - Bonnet Lock:** Carbon steel
 - Stem Seals:** Viton® O-ring, Teflon® back-up ring
 - Stem Seal Lock:** Carbon steel (soft seat type)
 - Stem Seat:** Delrin (soft seat type)
- Nickel-plated finish on carbon steel valves

Standard Features - Stainless Steel Model

- Pressure Rating:** Hard seat -10,000 psi @ 200°F max.
Soft seat - 6,000 psi @ 200°F max.
 - Valve Body:** 316 SS
 - Bonnet:** 316 SS
 - Valve Stem:** 316 SS (hard seat types with hard chromed tip and stem threads)
 - Handle:** 316 SS
 - Handle Bolt:** Stainless steel
 - Bonnet Lock:** Stainless steel
 - Stem Seals:** Viton® O-ring, Teflon® back-up ring
 - Stem Seal Lock:** Stainless steel (soft seat type)
 - Stem Seat:** Delrin (soft seat type)
- Electropolish finish on stainless steel valves

Type		910.11		
Hard Seat or Soft Seat Needle Valves				
Connection	Body Material	Size	Hard Seat	Soft Seat
			Part Number	Part Number
	Carbon steel	1/4" NPT	9698838	9698919
		3/8" NPT	4339925	
		1/2" NPT	9698846	9698927
		3/4" NPT	4339933	
	Stainless steel	1/4" NPT	9698855	9698935
		3/8" NPT	4339941	
	Carbon steel	1/4" NPT	9698871	9698952
		1/2" NPT	9698889	9698960
	Stainless steel	1/4" NPT	9698897	9698978
		1/2" NPT	9698901	9698986

Type		910.11		
Hard Seat 90° Angle Needle Valves				
Data Sheet	910.11			
Connection	Body Material	Size	Part Number	
	Carbon steel	1/4" NPT	9799295	
		1/2" NPT	9799308	
	Stainless steel	1/4" NPT	9799316	
		1/2" NPT	9799325	
	Carbon steel	1/4" NPT	9799333	
		1/2" NPT	9799341	
	Stainless steel	1/4" NPT	9799359	
		1/2" NPT	9799367	

Stock items shown in blue print.

Accessories > Mini-Needle Valves > 910.11.100

Type 910.11.100

Type 910.11.100 mini-needle valves can be used to isolate a pressure instrument from the application where space is limited. Three connection versions are available from stock.



Brass mini-valves supplied with knurled knob standard.



Carbon steel and stainless steel mini-valves supplied with T-handle.

Standard Features

Operating Temperature: Media: max. 200°F (+93°C);
min. 0°F (-18°C)
Flow Rate: Max. $C_v = 0.42$
Orifice Size: 0.172" (4.37mm)

Standard Features Brass Model

Pressure Rating: 6,000 psi
Valve Body: Brass
Bonnet: Brass
Valve Stem: Brass
Handle: Knurled knob, brass
Handle Bolt: Brass, 360
Stem Seals: Viton® O-ring,
Teflon® back-up ring

Standard Features Carbon Steel Model

Pressure Rating: 10,000 psi
Valve Body: Carbon steel
Bonnet: Carbon steel, 12L14
Valve Stem: 316 SS
Handle: T, carbon steel
Handle Bolt: Carbon steel, 12L14
Stem Seals: Viton® O-ring,
Teflon® back-up ring

Standard Features Stainless Steel Model

Pressure Rating: 10,000 psi
Valve Body: 316 SS, electropolished
Bonnet: 316 SS, electropolished
Valve Stem: 316 SS, electropolished
Handle: T, 316 SS, electropolished
Handle Bolt: Stainless steel
Stem Seals: Viton® O-ring,
Teflon® back-up ring

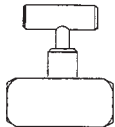
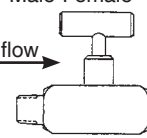
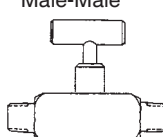
Type	910.11.100		
Mini Needle Valves			
Connection	Body Material	Size	Part Number
Female-Female 	Brass	1/8" NPT	4266120
		1/4" NPT	4266138
	Carbon steel	1/8" NPT	4266146
		1/4" NPT	4266154
	Stainless steel	1/8" NPT	4266162
		1/4" NPT	4266171
Male-Female flow → 	Brass	1/8" NPT	4266189
		1/4" NPT	4266197
	Carbon steel	1/8" NPT	4266201
		1/4" NPT	4266219
	Stainless steel	1/8" NPT	4266227
		1/4" NPT	4266235
Male-Male 	Brass	1/8" NPT	4266243
		1/4" NPT	4266251
	Carbon steel	1/8" NPT	4266260
		1/4" NPT	4266278
	Stainless steel	1/8" NPT	4266286
		1/4" NPT	4266294

Stock items shown in blue print.

Type 910.11.200

Intended to isolate the pressure gauge from the measured fluid or to provide a means of throttling or dampening pressure pulsation. Allows pressure to be bled-off prior to instrument removal or replacement.



Standard Features

Valve Body:	12L14 carbon steel, nickel plated or 316 SS, electropolished	Stem Seat (soft seat model):	Delrin
Bonnet:	12L14 carbon steel or 316 SS	Orifice Size:	0.187 inches (4.75 mm)
Valve Stem:	316 SS (hard chromed on hard seat types)	Pressure Rating:	Hard seat types-10,000 psi @ 200°F max. Soft seat types- 6,000 psi @ 200°F max.
Handle:	12L14 carbon steel or 316 SS	Operating Temperature:	Media: max. 200°F (+93°C); min. 0°F (-18°C)
Handle Bolt:	12L14 carbon steel or 18-8 SS	Flow Rate:	Hard seat types- Max. C _v 0.44 Soft seat types- Max. C _v 0.76
Stem Seals:	Viton® O-ring with PTFE back-up ring		
Stem Seal Lock (soft seat model):	12L14 carbon steel or 316 SS		

Type		910.11.200				
		Block & Bleed Needle Valves				
Connection		Body Material	Size	Part Number		
Female-Female 	Hard seat	Carbon steel	¼" NPT	4339682		
			½" NPT	4339691		
		Stainless steel	¼" NPT	4339704		
			½" NPT	4339712		
Male-Female flow → 	Hard seat	Carbon steel	¼" NPT	4339721		
			½" NPT	4339739		
		Stainless steel	¼" NPT	4339747		
			½" NPT	4339755		
Female-Female 	Soft seat	Carbon steel	¼" NPT	4339763		
			½" NPT	4339771		
		Stainless steel	¼" NPT	4339780		
			½" NPT	4339798		
		Male-Female flow → 	Soft seat	Carbon steel	¼" NPT	4339801
					½" NPT	4339810
Stainless steel	¼" NPT			4339828		
	½" NPT			4339836		

Stock items shown in blue print.

Accessories > Multi-Port Valves > 910.11.300

Type 910.11.300

Intended to isolate the pressure gauge from the measured fluid or to provide a means of throttling or dampening pressure pulsation. Allows additional instrument connections without adding permanent piping.



Standard Features

Valve Body:	12L14 carbon steel, nickel plated or 316 SS, electropolished	Stem Seat (soft seat types):	Delrin
Bonnet:	12L14 carbon steel or 316 SS	Orifice Size:	0.187 inches (4.75 mm)
Valve Stem:	316 SS (hard chromed on hard seat types)	Pressure Rating:	Hard seat types -10,000 psi @ 200°F max. Soft seat types 6,000 psi @ 200°F max.
Handle:	12L14 carbon steel or 316 SS	Operating Temperature Media:	max. 200°F (+93°C); min. 0°F (-18°C)
Handle Bolt:	12L14 carbon steel or 18-8 SSI	Flow Rate:	Hard seat type- Max. C _v 0.44 Soft seat type- Max. C _v 0.64
Stem Seals:	Viton® O-ring with PTFE back-up ring		
Stem Seal Lock (soft seat model):	12L14 carbon steel or 316 SS		

Available Options

- Panel mounting bracket

Type		910.11.300		
Multi-Port Needle Valves				
Connection	Seat	Body Material	Size	Part Number
	Hard seat	Carbon steel	1/2" NPT	4339844
		Stainless steel	3/4" male X 1/2" female NPT	4339852
			1/2" NPT	4339861
	Soft seat	Carbon steel	3/4" male X 1/2" female NPT	4339879
			1/2" NPT	4339887
		Stainless steel	3/4" male X 1/2" female NPT	4339895
1/2" NPT	4339909			
		Stainless steel	3/4" male X 1/2" female NPT	4339917

Stock items shown in blue print.

Accessories > Snubbers > 910.12.100 / 910.12.200 / 910.12.300

Type 910.12.100 / 910.12.200 / 910.12.300

Pressure snubbers protect pressure instruments against surges and pressure shocks. Porous snubbers are suitable for general purpose applications. Piston snubbers are supplied with three pistons to adapt to varying applications. Throttling snubbers have a built-in needle valve that allows you to adjust the amount of snubbing externally.

Standard Features

- Pressure Connection:** 1/4" NPT or 1/2" NPT male x female (see selection chart)
- Material:** Brass or stainless steel
- O-ring material (adjustable snubber only):** Brass: Buna-N
Stainless steel: Viton®
- Pressure Rating:** Brass: 3,000 psi - 5,000 psi;
Stainless steel: 5,000 psi - 15,000 psi (see selection chart)
- Temperature Rating:** 14°F to 248°F (-10°C to 120°C)



Available Options

- Other threaded connections
- Cleaned for use in oxygen service
- Monel® version
- Porous snubbers for different media types (specify media when ordering)

Type	910.12.100			
Porous Snubbers				
Application	Material	Connection	Pressure Rating	Part Number
Air, Steam, Gas	Brass	1/4" M x 1/4" F	5,000 psi	4341503
Light Oil, Water	Brass	1/4" M x 1/4" F	5,000 psi	4341511
Air, Steam, Gas	SS	1/4" M x 1/4" F	15,000 psi	4001524
Air, Steam, Gas	Brass	1/2" M x 1/2" F	5,000 psi	50409671
Air, Steam, Gas	SS	1/2" M x 1/2" F	15,000 psi	50409662

Type	910.12.200		
Piston Snubbers ¹			
Material	Connection	Pressure Rating	Part Number
Brass	1/4" NPT	5,000 psi	4201639
	1/2" NPT	5,000 psi	4201647
316 SS	1/4" NPT	15,000 psi	4201655
	1/2" NPT	15,000 psi	4201663

Type	910.12.300		
Throttling Snubbers ²			
Material	Connection	Pressure Rating	Part Number
Brass	1/4" NPT	3,400 psi	50334603
	1/2" NPT	3,400 psi	50334611
316 SS	1/4" NPT	5,800 psi	50334620
	1/2" NPT	5,800 psi	50334638

Notes:
¹ Supplied with five pistons for light to heavy snubbing
² Includes a stainless steel needle valve

Stock items shown in blue print.

Type 910.13

Type 910.13 over-pressure protectors protect pressure instruments from damaging spikes or surges. At a “pre-set” pressure, the over-pressure protector “shuts-off” the pressure to the instrument thus preventing damage to the pressure sensing element and protecting the calibration. The set-point is externally adjustable. Type 910.13 over-pressure protectors also feature an adjustable piston valve which is designed to dampen system pulsation.



Description

The over-pressure protector consists of a spring loaded piston valve. Under normal pressure conditions the spring holds the valve open. When the system pressure exceeds the set pressure, the force exerted by the spring is overcome and the valve closes. The valve will remain closed until the system pressure drops approximately 25% below the closing pressure, where upon the force of the spring will open the valve.

Over-pressure protectors must not be used as process control devices.

Standard Features

- Pressure connection:**
1/2" NPT male inlet, female outlet
- Body:** 316 Ti SS
- Piston Valve:** 316 Ti SS
- O-Ring:** FPM (Viton®)
- Operating Temperature:**
176 °F (80 °C maximum)
- Flow Direction:**
Male thread to female thread

Special Features

- 7 different setting ranges selectable
- Minimum pressure to 6 psi (0.4 bar)
- Maximum pressure to 8,700 psi (600 bar)
- Over-pressure safe up to 14,500 psi (1,000 bar)
- Vacuum safe

Special Options

- Other thread connections:
1/4" NPT, G1/4B and G1/2B
- Other materials: Brass, Monel® 400
- Material Certificate (3.1 acc. to EN 10 204)
- Nace Certificate (2.2 acc. to EN 10 204)
- Oxygen service (oil and grease free)
- Mounted on pressure gauge with customer specifications, includes SS tag (note 2)
- Over-pressure protector set to customer specifications, includes SS tag (note 2)

Type	910.13	
Over-pressure Protector		
Range (psi)	Range (bar)	Part Number
6 to 35	0.4 to 2.5	9091963
30 to 85	2 to 6	9091971
85 to 365	5 to 25	9091980
290 to 870	20 to 60	0690600
725 to 3625	50 to 250	0690619
3,500 to 5,800	240 to 400	1615130
5,800 to 8,700	400 to 600	50311115
Factory Set Over-pressure Protectors (note 2)		
6 to 35	0.4 to 2.5	50681222
30 to 85	2 to 6	50681231
85 to 365	5 to 25	50681249
290 to 870	20 to 60	50681257
725 to 3,625	50 to 250	50681265
3,500 to 5,800	240 to 400	50681273
5,800 to 8,700	400 to 600	50681281

Stock items shown in blue print.

Note 2: Items come pre-set from factory. Customer must specify set or closing pressure. Choose factory set part numbers for pressure gauge mounting and/or factory preset.

Accessories > Test Port Plugs > 910.14.100

Type 910.14.100

WIKA's 910.14.100 pressure and temperature test port plugs allow media access ideally for hydronic pressure and temperature measurement, without disturbing the process. The pressure and temperature units are equipped with a self-sealing pierceable rubber diaphragm and are rated at 1,000 psi and 200°F (350°F available).

Standard Features

Pressure Connection:	1/4" NPT or 1/2" NPT male
Material:	Brass body; neoprene or nordel diaphragm core
Self-Sealing Diaphragm Material:	Neoprene or nordel
Pressure Rating:	1,000 psi
Temperature Rating:	Neoprene 32-200°F max.; Nordel 32-350°F max.



Type	910.14.100				
Test Port Plugs					
Material	Connection	Pressure Rating	Plug Core	Max. Temp Rating	Part Number
Brass	1/4" NPT-male	1,000 psi	Neoprene	200°F	4339950
Brass	1/2" NPT-male	1,000 psi	Neoprene	200°F	4339968
Brass	1/4" NPT-male	1,000 psi	Nordel	350°F	4343591
Brass	1/2" NPT-male	1,000 psi	Nordel	350°F	4343603

Stock items shown in blue print.

Accessories > Adaptors > 910.14.200

Type 910.14.200

Type 910.14.200 pressure gauge adaptors and fittings are used for the installation of pressure gauges and pressure gauge accessories.

Standard Features

Male-Female Adaptor:	For adapting NPT to BSPP (metric connections)
Pressure Connection:	See sizes and other dimensions on chart
Materials:	Brass, 316 SS

Special Options Available

- Chrome-plated brass
- Alternate thread sizes



Type	910.14.200	
NPT to Metric Adaptors		
Material	Description	Part Number
Brass	1/4" NPT-female to G1/4B male	0084514
Brass	1/2" NPT-female to G1/2B male	0187143
Stainless steel	1/4" NPT-female to G1/4B male	1247573
Stainless steel	1/2" NPT-female to G1/2B male	0634603

Note: Sealing "O-ring" on "G" connection not included

Stock items shown in blue print.

Accessories > Couplings > 910.14.300

Type 910.14.300

WIKA offers couplings in a variety of connection sizes and materials. Couplings can be used for adapting siphons and any other instrumentation to the process.



Standard Features

Male-Male Adaptor: For joining two male connections, e.g. pressure gauge and gauge siphon, standard versions

Pressure Connection: Sizes and other dimensions on chart

Materials: Brass, carbon steel, 316 SS

Available Options

- Chrome-plated brass
- Alternate thread sizes

Type	910.14.300	
Couplings (for siphons)		
Connection	Body Material	Part Number
1/4" X 1/4" NPT female	Brass	1652974
	Steel	1652982
	Stainless steel	1652990
1/2" X 1/2" NPT female	Brass	1653008
	Steel	1653016
	Stainless steel	1653024
	Chr. Moly	1601040

Stock items shown in blue print

Accessories > Mini-Siphon > 910.24

Type 910.24

The WIKA mini-siphon is designed specifically to replace the old pigtail and coil siphon. The mini-siphon has a thermal barrier which protects the pressure gauge from harmful steam, hot vapors and liquids, and contains a unique inner chamber that reduces pressure surges and “water hammer”. The mini-siphon also eliminates gauge whip and vibration that is typically found on traditional siphons by mounting the gauge closer to the process.

Standard Features

Materials:

Body: 316 Ti SS (1.4571)

Internal Chamber: 316 Ti SS (1.4571)

Mounting Position: Vertical or horizontal

Connection: 1/2" NPT-male to 1/2" NPT-female

Flow: Male to female connection

Inlet Orifice: 0.1575 inches (4mm)

Maximum Media Pressure: 6,092 psi @ 212 °F

Maximum Media Temperature: 1,062 °F @ 2,611 psi

Available Options

- Other thread connections: 1/4" NPT, G1/4B and G1/2B
- Other materials: Monel® 400, Hastelloy®, Titanium, and Duplex
- Material Certificate (3.1 acc. to EN 10 204)
- NACE Certificate (2.2 acc. to EN 10 204)
- Oxygen service (oil and grease free)



Type	910.24			
Mini-Siphon				
Body Material	Conn. Size	Pressure Rating	Temp. Rating	Part Number
Stainless steel	1/2" NPT	6,092 psi	1062 °F	50673670

Stock items shown in blue print

For datasheets and additional information, please visit www.wika.com or call 1-888-945-2872.

Accessories > Siphons > 910.15.100 / 910.15.200

Type 910.15.100 / 910.15.200

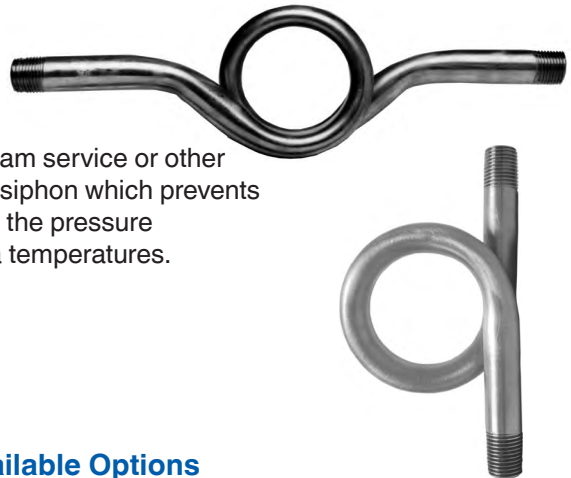

Siphons should be used to protect pressure instruments in live steam service or other hot vapor applications. The vapor condenses inside the coil of the siphon which prevents the high temperature vapors from reaching the sensing element of the pressure instrument. Additionally siphons assists in lowering process media temperatures.

Standard Features

- Forms:** Pigtail siphon, Coil siphon
- Materials:** Brass, Steel A120 schedule 40, Steel A106B schedule 80 & 160, 316 SS schedules 40, 80 & 160, Chrome Moly steel (A335 P22) XX Heavy
- Media Temperature Reduction:** Approximately 75°F for each 1 foot lineal section of pipe. Actual reduction dependent on process/application variables.

Available Options

- Alternate threads
- Special alloy material
- Cleaned for oxygen service
- Material certificate

Note: When first installed, siphon should be filled with water or any other suitable separating liquid.

Type	910.15.100				
Pigtail Siphon					
Siphon Form	Body Material	Size	Press. Rating	Temp. Rating	Part Number
	Brass	¼" NPT	250 psi	400 °F	4201779
	Steel, sch 40	¼" NPT	500 psi	400 °F	4201787
	316 SS, sch 40	¼" NPT	500 psi	400 °F	4201761
	316 SS, sch 80	½" NPT	2,600 psi	500 °F	4362719

Type	910.15.200				
Coil Siphon					
Siphon Form	Body Material	Size	Press. Rating	Temp. Rating	Part Number
	Brass	¼" NPT	250 psi	400 °F	4201809
	Steel, sch 40	¼" NPT	500 psi	400 °F	4201817
	Steel, sch 80	¼" NPT	3,360 psi	400 °F	4201825
	Steel, sch 80	½" NPT	3,000 psi	400 °F	4201833
	Steel, sch 160	½" NPT	3,620 psi	700 °F	4201841
	316 SS, sch 80	½" NPT	2,650 psi	500 °F	4201850
	316 SS, sch 160	½" NPT	5,600 psi	500 °F	4201795
	Chr. Moly (XXH)	½" NPT	8,205 psi	750 °F	4201868

Stock items shown in blue print

CP3000 / CP4000

WIKA indicating pressure switches combine local pressure indication with alarm and control capabilities into a single economical, reliable and compact system. Superior to conventional gauge and switch connections, WIKA indicating pressure switches are extremely reliable, have low hysteresis, resist corrosion and have easy set point adjustments. WIKA pressure switches are ideally suited for alarm and control functions on hydraulic, pneumatic and general industrial machinery and equipment. Additionally, pressure switches are used in process industry installations, including chemical and petrochemical plants, oil refineries, electric power plants, pulp and paper mills, and water / wastewater treatment plants.



Standard Features

Area of Installation:	Non-hazardous
Indicating Pressure Range:	0-60 to 0-20,000 psi
Set Point Pressure Range:	0-30 to 0-20,000 psi
Contact Rating AC:	24-220VAC, 65VA
Switching Hysteresis:	± 3.0%

Available Options

- Contact assembly available for 6" process gauge (2XX.34)

Type		CP3000	
Magnetically Assisted Alarm Contacts for 4½" Process Gauges			
Contact Type	Contact Arrangement	Installed	Sold Separately
		Part Number	Part Number
828.1	N.O.	828.1	774901
828.2	N.C.	828.2	774910
828.11	N.O./N.O.	828.11	774928
828.12	N.O./N.C.	828.12	691178
828.21	N.C./N.O.	828.21	691186
828.22	N.C./N.C.	828.22	774936
Adder to remove Triacs for DC Service		NO TRIAC	
Silicone fill (intalled only)		SIL	

NOTE: Gauge accuracy changes from 0.5% to 1.0% of Full Span when contact assembly is installed.

Type		CP4000	
Inductive Proximity Alarm Contacts for 4½" Process Gauges			
Contact Type	Contact Arrangement	Installed	Sold Separately
		Part Number	Part Number
838.1	N.O.	838.1	771775
838.2	N.C.	838.2	1193368
838.11	N.O./N.O.	838.11	771791
838.12	N.O./N.C.	838.12	1193376
838.21	N.C./N.O.	838.21	1193384
838.22	N.C./N.C.	838.22	1193392
Permanently attach reset knob			2069334

NOTE: Intrinsically Safe (Type SN) with Fail/Safe Control is available as a special order option.
Gauge accuracy changes from 0.5% to 1.0% of Full Span when contact assembly is installed.

Abbreviations
N.O. - Normally open
N.C. - Normally closed

Stock items shown in blue print

CP3000 / CP4000

CP3000 - Magnetically-Assisted Contacts

CP3000 magnetically assisted contacts feature one or two magnetically-assisted mechanical contacts. The contact assembly includes a built-in Triac switching amplifier which minimizes contact wear and allows load switching to 65VA. In this design, a movable contact couples to the gauge pointer through a special adaptor. As the contact approaches the set pointer, the magnetic force of a small permanent magnet attached to the set pointer assists in closing and holding the contacts in place. This avoids arching and reduces contact wear. The switching amplifier further reduces potential wear by its ability to switch large load currents with small control current. The technical specifications are listed in Table 1 on the next page. These switches are designed for use on alternating current (for DC consult WIKA).

CP4000 - Inductive Proximity Sensors

CP4000 inductive proximity sensors feature one or two inductive non-contact proximity sensors in place of mechanical contacts and provide a high degree of reliability and operating safety. The system consists of a sensing head, containing two axial coils with air gap, a metallic control flag and a switching amplifier. The sensing head is carried by the set pointer, while the control flag is coupled to the gauge pointer by way of a special adaptor. Movement of the control flag in and out of the air gap causes an impedance change in the transistor oscillator circuit formed by the two coils which in turn triggers the switching amplifier. When the flag is inside the slot, circuit impedance is high and the contact relay is de-energized. Conversely, when the flag is outside the slot, the relay is energized. The technical specifications are listed in Table 1 on the next page.

Control Units for CP4000

The switching amplifier and control relay are housed in a separate control unit. Depending on the type of control unit used, inductive proximity sensor systems can be furnished in the following versions: standard for nonhazardous locations; intrinsically safe for hazardous locations; intrinsically safe with fail-safe circuitry. Control units are FM approved for use in Division I, Classes I and II, Groups A through G hazardous locations. The control units must be located outside the hazardous area. (See Table on next page).

Fail Safe Circuitry

Type SN inductive proximity sensor together with control unit type 904.17 is self monitoring, and its function is superimposed on the regular control function. Should any fault occur in the sensing head (such as short or open circuit, power failure or component failure), the control wiring or the control unit, the output relay is automatically de-energized.

Control Units

Required for inductive proximity alarm contacts - sold separately

Type	904.XX			
Control Units for Inductive Proximity Alarm Contacts				
Contact Rating	Type	Use	For Use With	Part Number
220 VAC, 5A, 1100 VA	904.25	General use	Single contacts type 838.X	1195298
	904.26	General use	Double contacts type 838.XX	1195310
250 VAC, 4A, 500 VA	904.15	Intrinsically safe ¹	Single contacts type 838.X	2367446
	904.16	Intrinsically safe ¹	Double contacts type 838.XX	2314762
	904.17	Intrinsically safe ¹	Fail safe (for one contact)	2014548

¹ Intrinsically Safe (FM Approved)

Stock items shown in blue print

CP3000 / CP4000

Table 1

Contact	Magnetic CP3000	Inductive Proximity CP4000				
		Non-Hazardous		Hazardous Environment <FM>Control		
Unit #	(Built-in Triac)	904.25 MSR010-1	904.26 MSR020-1	904.15 WE77/EX-1	904.16 WE77/EX-2	904.17 Fail-safe WE77/EX-SH-03
Indicating Pressure Range	0/60 to 0/20,000 psi	0/30 to 0/20,000 psi				
Set Point Pressure Range	30 - 20,000 psi	5 - 20,000 psi				
Momentary Pressure	130%	130%				
Switching Hysteresis	± 3.0% FS	± 1.0% FS				
Operating Voltage	110 VAC/60Hz	110 VAC/60Hz				
Contact Rating	24-220 VAC, 65 VA ¹	220 VAC, 5A, 1100VA	250 VAC, 4A, 500VA	30V, 1.6A		
Switching Frequency (Max)	---	20 Hz	10Hz	0.5 Hz		
Control Circuit						
Voltage	---	---	8 VDC	8 VDC		
Current	min 30mA	---	100 Ohms	---		
Allowable Ext. Inductance	---	---	31 mH / 7.6 mH	32 mH		
Allowable Ext. Capacitance	---	---	609 nF / 539 nF	804 nF		
Ambient Temperature Range	-10° to 140° F	-10° to 140°F	-10° to 140° F	-10° to 140°F		

Table 2

Contact Type	Control System	Area of Installation	# Of Contacts	Control Unit ²	Control Unit Type Number
Magnetically-assisted	Standard	Non-hazardous	1	--- 0	
			2	--- 0	
Inductive Proximity			1	904.25	1
			2	904.26	2
	Intrinsically safe	Hazardous	1	904.15	3
			2	904.16	4
Inductive Proximity Type SN	Intrinsically safe with fail-safe control		1	904.17	5
			2	904.17 ³	6

Table 3

Contact Arrangement	
Function	Type Number
N.O.	8X8.1
N.C.	8X8.2
N.O. / N.O.	8X8.11
N.O. / N.C.	8X8.12
N.C. / N.O.	8X8.21
N.C. / N.C.	8X8.22

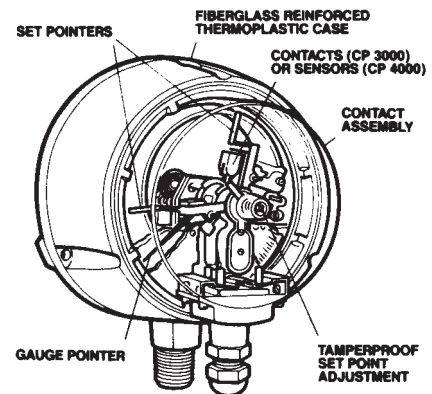

¹ Minimum current of 10 mA must continuously flow from load.
² Type 904 control units are combination power supply, switching modules for panel or relay rack mount. 904.15 & 904.25 units are 1.57" (40mm) wide, 2.76" (70mm) high and 4.33" (110mm) deep with mounting holes on 1.18" (30mm) horizontal & 2.36" (60mm) vertical centers. The wider 904.16/17 and 904.26 units are 2.35" (60mm) wide with 1.96" (50mm) horizontal mounting centers. Minimum mounting screw clearance is .19" (4.8mm).
³ Requires 2 units, one per contact.

Accessories > Socket Restrictor/Drag Pointer/Alarm Contacts

Socket Restrictor / Drag Pointer / Alarm Contacts

WIKA offers a full line of gauge accessories, including socket restrictors, drag pointers and alarm contacts. Each of these products is an enhancement to the extensive WIKA product line.

Socket Restrictor

Available in brass, stainless steel or Monel[®], the socket restrictor reduces the size of the internal bore. The restrictor dampens the effects of pulsation which in turn helps prevent internal damage to the Bourdon tube and movement and extends the life of the gauge.

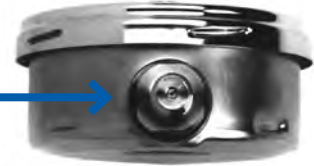

Drag Pointer (High Point Indicator)

The red drag pointer follows the regular pointer on increasing pressure and remains at the highest point until it is reset by a knob on the front of the window. Drag pointers are best suited for dry gauges.



Alarm Contacts

Many WIKA 2" (830.1E), 2½", 4", 4½" and 6" pressure gauges can be supplied with alarm contacts. Both inductive and magnetically-assisted contacts are available for dry and liquid-filled gauges. In addition, alarm contact assemblies are available for intrinsically safe environments. Available on types 212.20, 23X.30, 23X.50, 2XX.34, 4XX.XX and 7XX.XX.



Pressure Gauge Accessories

Alternate Window Assemblies				
Gauge Size	Gauge Type	Window Type	Installed	Sold Separately
			Code	Part Number
2½"	611.10	Instrument glass ¹	GLS	1208152
	21X.40	Instrument glass	GLS	1208160
	21X.40	Safety glass	SG	1206761
	23X.30	High temp glass	HT	1327001
	23X.30	Instrument glass	GLS	1208195
	23X.30	Safety glass	SG	1613367
	23X.54	(PMMA) acrylic	PMMA	1397796
4"	612.20	Safety glass	SG	54380
	21X.40	Safety glass	SG	1208190
	2XX.54	PC/Lexan®	PC	1376675
4½"	2X2.34 / 632.34	Instrument glass	GLS	561134
	2X2.34 / 632.34	Safety glass	SG	561150
6"	2XX.34	Safety glass	SG	154075

Adjustable Pointers		
Gauge Size	Gauge Type	Sold Separately
		Part Number
2½"	232.54	1552813
	232.30	060992
4"	232.54	1398709
6"	232.50	061000

Liquid Fill Adders (Add to the list price of a liquid fillable gauge)				
Fill Type	2½"	4"	4½" ²	6"
Silicone				
	SIL	SIL	SIL	SIL
Halocarbon®				
	HALO	HALO	HALO	HALO
Fluorolube®				
	FLR	FLR	FLR	FLR

NOTE: Any discount that applies to a pressure gauge also applies to its related accessories. All "Assemblies" sold separately include any additional parts (i.e. screws, gaskets, etc.) needed for installation.

Notes:

¹ Includes black steel friction ring

² Includes installation of membrane and fill plug for LM only.

NOTE: Only inert (Halocarbon/Fluorolube) fill fluid is compatible for use with oxygen service

Pressure Gauge Accessories

Drag Pointer Assemblies					
Gauge Size	Gauge Type	Window Type	Reset Knob Type	Installed	Sold Separately
				Code	Part Number
2½"³	232.30³	Acrylic	Permanent	DP	759805
	213.40¹	Acrylic	Permanent	DP	738344 ⁴
	2XX.53³	Acrylic	Permanent	DP	1193864 ⁴
	2XX.54³	Acrylic	Permanent	DP	1416405
4"	213.40¹	Glass	Removeable	DP GLR	738352 ⁴
	213.40¹	Acrylic	Permanent	DP	1326651 ⁴
	213.40¹	Acrylic²	Permanent	DP	738395 ⁴
	2XX.53 / 2XX.54	Acrylic	Permanent	DP	1416570 ⁴
	2XX.53 / 2XX.54	Acrylic	Removeable	DP PMMAR	1410911
	232.30 / 232.50	Acrylic	Permanent	DP	1326635
	232.30 / 232.50	Acrylic²	Permanent	DP PMMA	1206133
	232.30 / 232.50	Acrylic	Removeable	DP PMMAR	738360
	232.30 / 232.50	Glass	Permanent	DP GL	1326678
	232.30 / 232.50	Glass²	Permanent	DP GL	738425
	232.30 / 232.50	Glass	Removeable	DP GLR	738387
	232.30 / 232.50	Safety glass	Permanent	DP SG	1326660
232.30 / 232.50	Safety glass²	Permanent	DP SG	738417	
232.30 / 232.50	Safety glass	Removeable	DP SGR	738379	
4½"	2X2.34	Acrylic	Permanent	DP	738441
	2X2.34	Acrylic	Removeable	DP PMMAR	738433
6"	232.50 / 312.20	Acrylic	Permanent	DP	738492
	232.50 / 312.20	Acrylic	Removeable	DP PMMAR	738450
	232.50 / 312.20	Glass	Permanent	DP GL	738506
	232.50 / 312.20	Glass	Removeable	DP GLR	738476
	232.50 / 312.20	Safety glass	Permanent	DP SG	738484
	232.50 / 312.20	Safety glass	Removeable	DP SGR	738468
Attach "removeable" knob with permanent adhesive				2069334	

Notes:

¹ Minimum pressure range of 160 psi is required. Due to its high viscosity, the standard glycerine filling is replaced with a glycerine/water filling.

Accuracy is reduced to ± 5.0% of full span.

² Use for pressures equal to or below 30 psi full span.

³ For 2½" drag pointers: For pressure ranges ≤100 psi ; Additional accuracy reduction: DRY: ±3%FS, LF:±5%

⁴ For pressure ranges > 100 psi; Additional accuracy reduction: DRY: ± 1.5%FS, LF:±3%

⁵ Special tooling required for Part Numbers 738344, 1193864, 738352, 1326651, 738395 & 1416570

Certificates of Calibration

Traceable to NIST standards

NIST Standard	Part Number
± 0.1% accuracy (Type 342.XX)	CC
± 0.25% accuracy (Type 3X2.20 / 332.X4)	CC
± 0.5% to ±3/2/3% accuracy¹	CC

¹Any discount that applies to a pressure gauge also applies to this NIST certificate

Certifying Gauges to ASME B40.100 Cleanliness Level IV

(Includes cap on socket. Individually bagged and labeled)

Gauge Type	Sold Separately
111.XX	2250578
2X2.53, 2X2.54, 132.53, 2X2.34 LM, 2X2.25HR, & 332.54	2250560
712.XX	2250586

NOTE: Any discount that applies to a pressure gauge also applies to its related accessories. All "Assemblies" sold separately include any additional parts (i.e. screws, gaskets, etc.) needed for installation.

Accessories >> General Information > Pressure Gauge Accessories

Pressure Gauge Accessories

Front Flange Assemblies - Sold Separately (Includes screws to mount to case where necessary)				
Gauge Size	Fits Gauge	Description	Mounting	Part Number
2"	111.12	Black painted steel	Screw retained ²	1327080
	111.12	Chrome plated steel	Screw retained ²	1327082
	21X.53	Stainless steel polished	Arbor press ¹	1184954
2½"	111.12	Black painted steel	Screw retained ²	1327084
	111.12	Chrome plated steel	Screw retained ²	1327086
	113.13	Black ABS plastic	Snap-fit	572861
	213.40	Brass polished	Screw retained	1327116
	213.40	Chrome plated steel	Screw retained	1327118
	213.40	Stainless steel polished	Screw retained	1327114
	23X.30/50	Stainless steel polished	Bayonet	50618393
	2XX.53	Stainless steel polished	Arbor press ¹	4005899
	23X.54	Stainless steel polished	Arbor press ¹	4005902
	611.10	Chrome plated brass (CBM)	Screw retained	659606
611.10	Black painted steel (CBM)	Screw retained	659614	
4"	212.20	Stainless steel polished	Bayonet lock	659576
	213.40	Chrome plated brass	Screw retained	501115
	2XX.53 / 54	Stainless steel polished	Arbor press ¹	1418556
	232.30/50	Stainless steel polished	Bayonet lock	659576
	612.20	Stainless steel polished	Bayonet lock	659576
4½" Panel Adapters	632.50	Stainless steel polished	Bayonet lock	659576
	213.40	Stainless steel polished	Screw-retained	738549
	2XX.53/2XX.54	Stainless steel polished	Arbor press ¹	1653903
6"	2XX.34	Stainless steel polished	Hand-threaded	738581
	212.20	Stainless steel polished	Bayonet lock	659584
	232.30/50	Stainless steel polished	Bayonet lock	659584
	312.20	Stainless steel polished	Bayonet lock	659584

Rear Flange Assemblies - Sold Separately (Includes screws to mount to case where necessary)				
Gauge Size	Fits Gauge	Description	Mounting	Part Number
2½"	213.40	Polished brass	Screw retained ²	1206621
	2XX.53	Polished stainless steel	Snap-fit, crimp tab ³	1491695
	2XX.54	Polished stainless steel	Snap-fit, crimp tab ³	2256096
4"	111.10	Black ABS plastic	Screw-retained	1207555
	213.40	Chrome plated brass	Screw retained ²	1206630
	2XX.53	Polished stainless steel	Snap-fit, crimp tab ³	1572865
4½"	2XX.54	Polished stainless steel	Snap-fit, crimp tab ³	1572865
	111.25	Satin-finish stainless steel	Spot welded	4001605
6"	212.20	Polished stainless steel	Spot welded	1353217
	312.20	Polished stainless steel	Spot welded	1353217
	23X.50	Polished stainless steel	Spot welded	1353217

Notes:

¹ Special arbor press and fixtures required for installation. Contact factory for price and availability of press and fixtures.

² Special case required. Must be factory installed.

³ Rear flange snaps onto case. Two tabs must be crimped to secure flange to the case. Special tool available. Contact factory.

NOTE: Any discount that applies to a pressure gauge also applies to its related accessories. All "Assemblies" sold separately include any additional parts (i.e. screws, gaskets, etc.) needed for installation.

For datasheets and additional information, please visit www.wika.com or call 1-888-945-2872.

ACCESSORIES

U-clamp Assemblies - Sold Separately

Includes profile ring, bracket, & screws (where necessary)

Gauge Size	Fits Gauge	Profile Ring Material	Bracket Material	Mounting	Part Number
2"	21X.53	Polished stainless steel	Zinc plated steel	Twist-on socket	1184890
2 1/2"	213.40	Chrome plated steel	Zinc plated steel	Screw retained	0659665
	2XX.53	Polished stainless steel	Zinc plated steel	Snap-fit bracket	9092331
	2XX.53	Polished stainless steel	Stainless steel	Snap-fit bracket	1405829
	23X.54	Polished stainless steel	Zinc plated steel	Snap-fit bracket	1410334 ²
	23X.54	Polished stainless steel	Stainless steel	Snap-fit bracket	1410342 ²
4"	213.40	Chrome plated steel	Zinc plated steel	Screw retained	659673
	2XX.53	Polished stainless steel	Zinc plated steel	Snap-fit bracket	1487850
	2XX.53	Polished stainless steel	Stainless steel	Snap-fit bracket	1487841
	23X.54	Polished stainless steel	Zinc plated steel	Arbor press ¹	1410318
	23X.54	Polished stainless steel	Stainless steel	Arbor press ¹	1410326

Individual Restrictors - Sold Separately

Gauge Size	Description	Thread	Orifice	Part Number
212.20/21X.34	Brass threaded	M4	.023" (.6mm)	0004324
26X.34	Monel® threaded	M4	.023" (.6mm)	0607797
111.10/111.12/21X.53	Brass, press-in	--	.012" (.3mm)	0525340
All others	SS threaded for 1 1/2", 2", 2 1/2"	M3.5	.012" (.3mm)	0165522
	SS threaded for 2 1/2" ³ , 4", 4 1/2" & 6"	M4	.023" (.6mm)	0029122
	Brass threaded	M3.5	.020" (.5mm)	0030872

Miscellaneous Accessories

Gauge Size	Fits Gauge	Description	Part Number
2 1/2"	111.10 / 113.13 / 21X.53 / 23X.53 / 23X.50	Blue rubber cover - LM	9090894
	111.10 / 113.13 / 21X.53 / 23X.53 / 23X.50	Red rubber cover - LM	9090886
	111.12 / 21X.53 / 23X.53 / 23X.50	Blue rubber cover - CBM	2169542
4"	13X.53 / 21X.53 / 23X.53 / 23X.50	Blue rubber cover - LM	9090916
2"	111.12	Clear plastic adaptor ring ⁴	644838
	111.12	Black plastic adaptor ring ⁴	1601105
2 1/2"	111.12	Clear plastic adaptor ring ⁴	646989
	111.12	Black plastic adaptor ring ⁴	658332

¹ Installation requires special tooling. Contact factory for more information

² Includes U-Clamp and standoff ring

³ Use M4 size restrictor for current type 23X.5X with welded case-to-socket connection

⁴ For CBM only

Threaded restrictors require gauges to have an internal tap.

(Internal tap is standard on all 4 1/2" type 2xx.34 process gauges).

Press-in restrictors require a special tool for insertion.

Pressure Gauge Tools

Description	Part Number
Cover ring remover for Type 213.40 - 2 1/2"	1456784
Pointer puller tool	9091823
Spare tip for pointer puller tool	1400401
Threaded ring tool (for Type 2XX.34- 4 1/2")	1031589
Pointer puller adaptor for "Long-Hub"	2246954
Pointers (use with #9091823 above)	

Fill Liquids - Sold Separately

Fill Liquid	Size (Volume)	Part Number
Glycerine	Gallon (128 oz.)	251
	Squirt bottle (8 oz.)	204
Silicone oil	Gallon (128 oz.)	279
	Squirt bottle (8 oz.)	207
Halocarbon®	Squirt bottle (8 oz.)	206
Fluorolube®	Squirt bottle (8 oz.)	277

NOTE: Any discount that applies to a pressure gauge also applies to its related accessories. All "Assemblies" sold separately include any additional parts (i.e. screws, gaskets, etc.) needed for installation.

Tags

Size	Fits Gauge	Description	Code
All	All	SS tag (attached) with up to 10-char single-line imprint	TAG
All	All	Paper tag	PTAG

Pressure Gauge Accessories

Standard Pressure Ranges for all Sizes (All ranges not stocked)					
Single Scale Ranges			Dual Scale Ranges (psi / ...)		
psi	bar	kPa	/kg-cm ²	/bar	/kPa
30"Hg/0 (VAC)	-1	-100	-1	-1	-100
30"Hg/0/15 psi	-1 / +1	-100 / +100	-1 / +1	-1 / +1	-100 / +102
30"Hg/0/30 psi	-1 / +2.5	-100 / +250	-1 / +2.1	-1 / +2	-100 / +205
30"Hg/0/60 psi	-1 / +4	-100 / +400	-1 / +4.2	-1 / +4	-100 / +410
30"Hg/0/100 psi	-1 / +6	-100 / +600	-1 / +7	-1 / +6.8	-100 / +680
30"Hg/0/160 psi	-1 / +10	-100 / +1,000	-1 / +11	-1 / +11	-100 / +1,100
30"Hg/0/200 psi	-1 / +16	-100 / +1,600	-1 / +14	-1 / +13.5	-100 / +1,380
0/10	0/0.6	0/60	--	--	0/69
0/15	0/1	0/100	0/1.04	0/1.02	0/100
0/30	0/2.5	0/250	0/2.1	0/2.05	0/200
0/60	0/4	0/400	0/4.2	0/4.1	0/410
0/100	0/6	0/600	0/7	0/6.8	0/690
0/160	0/10	0/1,000	0/11.2	0/11	0/1,100
0/200	0/16	0/1,600	0/14	0/13.5	0/1,350
0/300	--	--	0/21	0/20.5	0/2,050
0/400	0/25	0/2,500	0/28	0/27	0/2,700
0/600	0/40	0/4,000	0/43	0/41	0/4,100
0/800	--	--	0/56	0/55	0/5,400
0/1,000	0/60	0/6,000	0/70	0/68	0/6,800
0/1,500	0/100	0/10,000	0/104	0/102	0/10,200
0/2,000	0/160	0/16,000	0/140	0/135	0/13,500
0/3,000	0/250	0/25,000	0/210	0/205	0/20,500
0/5,000	--	--	0/350	0/340	0/34,000
0/6,000	0/400	0/40,000	0/420	0/410	0/41,000
0/7,500			0/530	0/517	0/50,000
0/10,000	0/600	0/60,000	0/700	0/690	0/68,000
0/15,000	0/1,000	0/100,000	0/1,050	0/1,030	0/102,000
0/20,000	0/1,600	0/160,000	0/1,400	0/1,380	0/137,000

PSI / Ft. H ₂ O Dual Scales For Type 2XX.34 - 4 1/2"	
PSI	Ft. H ₂ O
30/0/15	-34/0/34
30/0/30	-34/0/70
30/0/60	-34/0/140
15	34
30	70
60	140
100	230
160	370
200	460

NOTE:
WIKA is capable of producing almost any type of custom artwork, including special scales, fonts and logos. Please contact your WIKA distributor or the factory for availability, price and lead times.

To order type 2XX.34 gauges with dual scale psi/ft. H₂O dials, specify gauge part number + the following numbers:

XXX = psi range desired

Ex: 232.34 4 1/2" XXX / psi / ft. H₂O 1/2" L

Accessories > General Information > Standard Dial Layouts

Standard Dial Layouts

Accuracy (+)3/2/3%, 2.5%, 1.5% (±) 2/1/2 & 1.0% F.S.
Types 1XX.XX and 2XX.XX
(nsee chart at right for 2XX.34 Process Gauges)

Accuracy + 0.5% of span
Type 2XX.34 Process Gauges

Accuracy + 0.25% of span
Type 3XX.XX Test Gauges

PRESSURE RANGES				
Size 1½", 2" & 2½"			Size 3½", 4" & 6"	
Range	Fig. Inter.	Grad. Inter.	Fig. Inter.	Grad. Inter.
PSI	PSI	PSI	PSI	PSI
10	2	0.2	--	--
15	3	0.2	3	0.2
30	5	0.5	5	0.5
60	10	1	10	1
100	20	2	10	1
160	20	2	20	2
200	50	5	20	2
300	50	5	50	5
400	100	10	50	5
600	100	10	100	10
800	200	20	100	10
1,000	200	20	100	10
1,500	300	20	300	20
2,000	500	50	200	20
3,000	500	50	500	50
5,000	1,000	100	500	50
7,500	1,000	100	---	--
10,000	2,000	200	1,000	100
15,000	3,000	200	3,000	2,000
20,000	---	---	2,000	200
VACUUM RANGE				
Range	Fig. Inter.	Grad. Inter.	Fig. Inter.	Grad. Inter.
30-0 "Hg	5 "Hg	0.5 "Hg	5 "Hg	0.5 "Hg
COMPOUND RANGES				
Range	Fig. Inter.	Grad. Inter.	Fig. Inter.	Grad. Inter.
" Hg PSI	" Hg PSI	" Hg PSI	" Hg PSI	" Hg PSI
30-0- 15	10 5	1 0.5	5 3	1 0.5
30-0- 30	10 10	2 1	10 5	1 0.5
30-0- 60	30 20	2 2	10 10	1 2
30-0- 100	30 20	5 2	30 10	2 2
30-0- 160	30 20	10 5	30 20	5 5
30-0- 200	30 50	10 5	30 20	5 5

PRESSURE RANGES		
Sizes 4½" & 6"		
Range	Fig. Inter.	Grad. Inter.
PSI	PSI	PSI
15	1	0.1
30	2	0.2
60	5	0.5
100	10	1
160	10	1
200	20	2
300	20	2
400	50	5
600	50	5
800	100	10
1,000	100	10
1,500	100	10
2,000	200	20
3,000	200	20
5,000	500	50
10,000	1,000	100
15,000	1,000	100
20,000	2,000	200
VACUUM RANGE		
Range	Fig. Inter.	Grad. Inter.
30-0 "Hg	5 "Hg	0.2 "Hg
COMPOUND RANGES		
Range	Fig. Inter.	Grad. Inter.
" Hg PSI	" Hg PSI	" Hg PSI
30-0- 15	5 3	0.5 0.2
30-0- 30	10 5	1 0.5
30-0- 60	10 10	1 1
30-0- 100	30 10	2 1
30-0- 160	30 20	5 2
30-0- 200	30 20	5 2

PRESSURE RANGES		
Sizes 4" & 6"		
Range	Fig. Inter.	Grad. Inter.
PSI	PSI	PSI
15	1	0.05
30	2	0.1
60	5	0.2
100	10	0.5
160	10	1
200	20	1
300	20	1
400	50	2
600	50	2
800	100	5
1,000	100	5
1,500	100	5
2,000	200	10
3,000	200	10
5,000	500	20
10,000	1,000	50
15,000	1,000	50
20,000	2,000	100
VACUUM RANGE		
Range	Fig. Inter.	Grad. Inter.
30-0 "Hg	5 "Hg	0.1 "Hg
COMPOUND RANGES		
Range	Fig. Inter.	Grad. Inter.
" Hg PSI	" Hg PSI	" Hg PSI
30-0- 15	5 5	0.2 0.1
30-0- 30	10 5	0.5 0.2
30-0- 60	10 5	1 0.5
30-0- 100	30 10	1 0.5
30-0- 160	30 10	2 1
30-0- 200	30 20	2 1

ABBREVIATIONS

Fig. Inter. - spacing between numbers (figures) printed on dial
Grad. Inter. - spacing between tick marks (graduations) printed on dial
F.S. - full scale.

All accuracies are percentages of the full scale range of the gauge.

Accessories > General Information > Standard Dial Layouts

Standard Dial Layouts

Accuracy + 0.1% of span

Type 341.11 Precision Test Gauges

Accuracy + 1.5% & 2.5% of span

Type 4XX.XX Sealgauges

Accuracy + 1.5% of span

Type 6XX.XX Low Pressure Gauges

PRESSURE RANGE			PRESSURE RANGES			PRESSURE RANGES				
Size 10"			Sealgaug® Sizes 4" & 6"			Size 2½"		Size 4"		
Range	Fig. Inter.	Grad. Inter.	Range	Fig. Inter.	Grad. Inter.	Range	Fig. Inter.	Grad. Inter.	Fig. Inter.	Grad. Inter.
PSI	PSI	PSI	in. Water	in. Water	in. Water	(dual Scale)	(dual Scale)	(dual Scale)	(dual Scale)	(dual Scale)
10	0.5	0.02	5	1	0.10	Inch. (mm)	Inch. (mm)	Inch. (mm)	Inch. (mm)	Inch. (mm)
15	0.5	0.02	10	1	0.10	Water Water	Water Water	Water Water	Water Water	Water Water
20	1	0.05	15	3	0.25	15 (380)	5 (100)	0.5 (10)	3 (50)	0.2 (5)
30	1	0.05	30	5	0.50	30 (760)	5 (200)	0.5 (20)	5 (100)	0.5 (10)
60	2	0.1	60	10	1	60 (1,500)	10 (500)	1 (50)	10 (300)	1 (20)
100	5	0.2	100	10	1	100 (2,500)	20 (500)	2 (50)	10 (500)	1 (50)
150	5	0.2	200	20	2	200 (5,000)	50 (1,000)	5 (100)	20 (1,000)	2 (100)
200	10	0.5	Range	Fig. Inter.	Grad. Inter.	Range	Fig. Inter.	Grad. Inter.	Fig. Inter.	Grad. Inter.
300	10	0.5	Oz./Sq. in.	Oz./Sq. in.	Oz./Sq. in.	(dual Scale)	(dual Scale)	(dual Scale)	(dual Scale)	(dual Scale)
400	20	1	5	1	0.10	Oz. (In. Water)	Oz. (In. Water)	Oz. (In. Water)	Oz. (mm Water)	Oz. (mm Water)
600	20	1	10	1	0.10	Sq. In. Water	Sq. In. Water	Sq. In. Water	Sq. In. Water	Sq. In. Water
800	20	1	15	3	0.25	10 (400)	2 (100)	0.2 (10)	1 (100)	0.1 (10)
1,000	50	2	20	2	0.20	15 (660)	5 (100)	0.5 (10)	3 (100)	0.2 (10)
1,500	50	2	30	5	0.50	20 (880)	5 (200)	0.5 (20)	2 (200)	0.2 (20)
2,000	100	5	35	5	0.50	30 (1,320)	5 (200)	0.5 (50)	5 (200)	0.25 (20)
3,000	100	5	60	10	1	35 (1,540)	5 (500)	0.5 (50)	5 (300)	0.5 (20)
4,000	200	10	100	20	2	60 (2,640)	10 (500)	1 (50)	10 (500)	1 (50)
5,000	500	10	180	50	5	Range	Fig. Inter.	Grad. Inter.	Fig. Inter.	Grad. Inter.
6,000	200	10	Range	Fig. Inter.	Grad. Inter.	(dual Scale)	(dual Scale)	(dual Scale)	(dual Scale)	(dual Scale)
7,500	500	20	PSI	PSI	PSI	Oz. (In. Water)	Oz. (In. Water)	Oz. (In. Water)	Oz. / Sq. In.	Oz. / Sq. In.
10,000	500	20	10	1	0.2	Sq. In. Water	Sq. In. Water	Sq. In. Water		
15,000	1,000	50	15	3	0.5	20 (400)	5 (100)	0.5 (10)	---	---
20,000	1,000	50	30	5	0.5	32 (660)	5 (100)	0.5 (10)	---	---
Range	Fig. Inter.	Grad. Inter.	60	10	1	Range	Fig. Inter.	Grad. Inter.	Fig. Inter.	Grad. Inter.
in. Water	in. Water	in. Water	100	10	1	PSI	PSI	PSi	PSI	PSI
300	10	0.5	160	20	2	3	0.5	0.05	0.5	0.05
400	20	1	200	20	2	5	1	0.1	0.5	0.5
500	20	1	300	50	5	10	2	0.2	1	0.1
600	20	1	400	50	5	VACUUM RANGE ¹				
800	20	1	600	50	5	Range	Fig. Inter.	Grad. Inter.	Fig. Inter.	Grad. Inter.
1,000	50	2	VACUUM RANGE ¹			30-0 "Hg	5 "Hg	0.5 "Hg		
VACUUM RANGE ¹			Range	Fig. Inter.	Grad. Inter.	COMPOUND RANGES				
Range	Fig. Inter.	Grad. Inter.	30-0 "Hg	5 "Hg	0.5 "Hg	Range	Fig. Inter.	Grad. Inter.	Fig. Inter.	Grad. Inter.
30-0 "Hg	2 "Hg	0.1 "Hg	COMPOUND RANGES			" Hg PSI	" Hg PSI	" Hg PSI		
COMPOUND RANGES			Range	Fig. Inter.	Grad. Inter.	30-0- 10	5 2	0.5 0.2		
Range	Fig. Inter.	Grad. Inter.	" Hg PSI	" Hg PSI	" Hg PSI	30-0- 15	5 3	1 0.5		
" Hg PSI	" Hg PSI	" Hg PSI	30-0- 10	5 2	0.5 0.2	30-0- 30	10 5	1 0.5		
30-0- 15	2 2	0.1 0.1	30-0- 15	5 3	1 0.5	30-0- 60	10 10	2 2		
30-0- 30	2 2	0.1 0.1	30-0- 30	10 5	1 0.5	30-0- 100	10 10	5 2		
30-0- 60	5 5	0.2 0.2	30-0- 60	10 10	2 2	30-0- 160	30 20	5 2		
30-0- 100	10 5	0.5 0.2	30-0- 100	10 10	5 2	30-0- 200	30 20	5 2		
30-0- 150	10 10	1 0.5	30-0- 160	30 20	5 2	30-0- 300	30 50	5 2		
30-0- 300	10 10	1 0.5	30-0- 200	30 20	5 2	30-0- 400	30 50	10 5		

Notes:
¹Pointer travel in vacuum range gauges is counter-clockwise

GENERAL INFORMATION

How to convert from °Celsius to °Fahrenheit, or °Fahrenheit to °Celsius

Locate the known temperature (either Fahrenheit or Celsius) in the center shaded column.

Read left to convert from Celsius to Fahrenheit,
or right to convert from Fahrenheit to Celsius.

To °F	From	To °C	To °F	From	To °C	To °F	From	To °C	To °F	From	To °C	To °F	From	To °C	To °F	From	To °C
-148	-100	-73.33	75.2	24	-4.51	298.4	148	64.31	521.6	272	133.13	744.8	396	201.95	968	520	271.11
-144.4	-98	-72.22	78.8	26	-3.4	302	150	65.42	525.2	274	134.24	748.4	398	203.06	971.6	522	272.22
-140.8	-96	-71.11	82.4	28	-2.29	305.6	152	66.53	528.8	276	135.35	752	400	204.17	975.2	524	273.33
-137.2	-94	-70	86	30	-1.18	309.2	154	67.64	532.4	278	136.46	755.6	402	205.28	978.8	526	274.44
-133.6	-92	-68.89	89.6	32	-0.07	312.8	156	68.75	536	280	137.57	759.2	404	206.39	982.4	528	275.56
-130	-90	-67.78	93.2	34	1.04	316.4	158	69.86	539.6	282	138.68	762.8	406	207.5	986	530	276.67
-126.4	-88	-66.67	96.8	36	2.15	320	160	70.97	543.2	284	139.79	766.4	408	208.61	989.6	532	277.78
-122.8	-86	-65.56	100.4	38	3.26	323.6	162	72.08	546.8	286	140.9	770	410	209.72	993.2	534	278.89
-119.2	-84	-64.45	104	40	4.37	327.2	164	73.19	550.4	288	142.01	773.6	412	210.83	996.8	536	280
-115.6	-82	-63.34	107.6	42	5.48	330.8	166	74.3	554	290	143.12	777.2	414	211.94	1000.4	538	281.11
-112	-80	-62.23	111.2	44	6.59	334.4	168	75.41	557.6	292	144.23	780.8	416	213.05	1004	540	282.22
-108.4	-78	-61.12	114.8	46	7.7	338	170	76.52	561.2	294	145.34	784.4	418	214.16	1007.6	542	283.33
-104.8	-76	-60.01	118.4	48	8.81	341.6	172	77.63	564.8	296	146.45	788	420	215.27	1011.2	544	284.44
-101.2	-74	-58.9	122	50	9.92	345.2	174	78.74	568.4	298	147.56	791.6	422	216.38	1014.8	546	285.56
-97.6	-72	-57.79	125.6	52	11.03	348.8	176	79.85	572	300	148.67	795.2	424	217.49	1018.4	548	286.67
-94	-70	-56.68	129.2	54	12.14	352.4	178	80.96	575.6	302	149.78	798.8	426	218.6	1022	550	287.78
-90.4	-68	-55.57	132.8	56	13.25	356	180	82.07	579.2	304	150.89	802.4	428	219.71	1040	560	293.33
-86.8	-66	-54.46	136.4	58	14.36	359.6	182	83.18	585.8	306	152	806	430	220.82	1058	570	298.89
-83.2	-64	-53.35	140	60	15.47	363.2	184	84.29	586.4	308	153.11	809.6	432	221.93	1076	580	304.44
-79.6	-62	-52.24	143.6	62	16.58	366.8	186	85.4	590	310	154.22	813.2	434	223.04	1094	590	310
-76	-60	-51.13	147.2	64	17.69	370.4	188	86.51	593.6	312	155.33	816.8	436	224.15	1112	600	315.66
-72.4	-58	-50.02	150.8	66	18.8	374	190	87.62	597.2	314	156.44	820.4	438	225.26	1130	610	321.11
-68.8	-56	-48.91	154.4	68	19.91	377.6	192	88.73	600.8	316	157.55	824	440	226.37	1148	620	326.67
-65.2	-54	-47.8	158	70	21.02	381.2	194	89.84	604.4	318	158.66	827.6	442	227.48	1166	630	332.22
-61.6	-52	-46.69	161.6	72	22.13	384.8	196	90.95	608	320	159.77	831.2	444	228.59	1184	640	337.78
-58	-50	-45.58	165.2	74	23.24	388.4	198	92.06	611.6	322	160.88	834.8	446	229.7	1202	650	343.33
-54.4	-48	-44.47	168.8	76	24.35	392	200	93.17	615.2	324	161.99	838.4	448	230.81	1220	660	348.89
-50.8	-46	-43.36	172.4	78	25.46	395.6	202	94.28	618.8	326	163.1	842	450	231.92	1238	670	354.44
-47.2	-44	-42.25	176	80	26.57	399.2	204	95.39	622.4	328	164.21	845.6	452	233.03	1256	680	360
-43.6	-42	-41.14	179.6	82	27.68	402.8	206	96.5	626	330	165.32	849.2	454	234.14	1274	690	365.56
-40	-40	-40.03	183.2	84	28.79	406.4	208	97.61	629.6	332	166.43	852.8	456	235.25	1292	700	371.11
-36.4	-38	-38.92	186.8	86	29.9	410	210	98.72	633.2	334	167.54	856.4	458	236.36	1310	710	376.67
-32.8	-36	-37.81	190.4	88	31.01	413.6	212	99.83	636.8	336	168.65	860	460	237.47	1328	720	382.22
-29.2	-34	-36.7	194	90	32.12	417.2	214	100.94	640.4	338	169.76	863.6	462	238.58	1346	730	387.78
-25.6	-32	-35.59	197.6	92	33.23	420.8	216	102.05	644	340	170.87	867.2	464	240	1364	740	393.33
-22	-30	-34.48	201.2	94	34.34	424.4	218	103.16	647.6	342	171.98	870.8	466	241.11	1382	750	398.89
-18.4	-28	-33.37	204.8	96	35.45	428	220	104.27	651.2	344	173.09	874.4	468	242.22	1400	760	404.44
-14.8	-26	-32.26	208.4	98	36.56	431.6	222	105.38	654.8	346	174.2	878	470	243.33	1418	770	410
-11.2	-24	-31.15	212	100	37.67	435.2	224	106.49	658.4	348	175.31	881.6	472	244.44	1436	780	415.56
-7.6	-22	-30.04	215.6	102	38.78	438.8	226	107.6	662	350	176.42	885.2	474	245.55	1454	790	421.11
-4	-20	-28.93	219.2	104	39.89	442.4	228	108.71	665.6	352	177.53	888.8	476	246.66	1472	800	426.67
-0.4	-18	-27.82	222.8	106	41	446	230	109.82	669.2	354	178.64	892.4	478	247.77	1490	810	432.22
3.2	-16	-26.71	226.4	108	42.11	449.6	232	110.93	672.8	356	179.75	896	480	248.88	1508	820	437.78
6.8	-14	-25.6	230	110	43.22	453.2	234	112.04	676.4	358	180.86	899.6	482	250	1526	830	443.33
10.4	-12	-24.49	233.6	112	44.33	456.8	236	113.15	680	360	181.97	903.2	484	251.11	1544	840	448.89
14	-10	-23.38	237.2	114	45.44	460.4	238	114.26	683.6	362	183.08	906.8	486	252.22	1562	850	454.44
17.6	-8	-22.27	240.8	116	46.55	464	240	115.37	687.2	364	184.19	910.4	488	253.33	1580	860	460
21.2	-6	-21.16	244.4	118	47.66	467.6	242	116.48	690.8	366	185.3	914	490	254.44	1598	870	465.56
24.8	-4	-20.05	248	120	48.77	471.2	244	117.59	694.4	368	186.41	917.6	492	255.55	1616	880	471.11
28.4	-2	-18.94	251.6	122	49.88	474.8	246	118.7	698	370	187.52	921.2	494	256.66	1634	890	476.67
32	0	-17.83	255.2	124	50.99	478.4	248	119.81	701.6	372	188.63	924.8	496	257.77	1652	900	482.22
35.6	2	-16.72	258.8	126	52.1	482	250	120.92	705.2	374	189.74	928.4	498	258.88	1670	910	487.78
39.2	4	-15.61	262.4	128	53.21	485.6	252	122.03	708.8	376	190.85	932	500	260	1688	920	493.33
42.8	6	-14.5	266	130	54.32	489.2	254	123.14	712.4	378	191.96	935.6	502	261.11	1706	930	498.89
46.4	8	-13.39	269.6	132	55.43	492.8	256	124.25	716	380	193.07	939.2	504	262.22	1724	940	504.44
50	10	-12.28	273.2	134	56.54	496.4	258	125.36	719.6	382	194.18	942.8	506	263.33	1742	950	510
53.6	12	-11.17	276.8	136	57.65	500	260	126.47	723.2	384	195.29	946.4	508	264.44	1760	960	515.56
57.2	14	-10.06	280.4	138	58.76	503.6	262	127.58	726.8	386	196.4	950	510	265.55	1778	970	521.11
60.8	16	-8.95	284	140	59.87	507.2	264	128.69	730.4	388	197.51	953.6	512	266.66	1796	980	526.67
64.4	18	-7.84	287.6	142	60.98	510.8	266	129.8	734	390	198.62	957.2	514	267.77	1814	990	532.22
68	20	-6.73	291.2	144	62.09	514.4	268	130.91	737.6	392	199.73	960.8	516	268.88	1832	1000	537.78
71.6	22	-5.62	294.8	146	63.2	518	270	132.02	741.2	394	200.84	964.4	518	270			

$$^{\circ}\text{F} = (9/5 ^{\circ}\text{C}) + 32 \quad ^{\circ}\text{C} = 5/9 (^{\circ}\text{F} - 32)$$

Accessories > General Information > Pressure Units Cross Reference Chart

Pressure Units Cross Reference Chart

PSI	atms.	H ₂ O	mm H ₂ O	cm H ₂ O	oz/in ²	Kg/cm ²	"Hg
1	0.0681	27.71	703.8	70.38	16	0.0704	2.036
14.7	1	407.2	10,343	1,034.3	235.1	1.033	29.92
0.0361	0.00246	1	25.4	2.54	0.5775	0.00254	0.0735
0.001421	0.000097	0.0394	1	0.1	0.0227	0.0001	0.00289
0.01421	0.000967	0.3937	10	1	0.227	0.001	0.0289
0.0625	0.00425	1.732	43.986	4.40	1	0.0044	0.1273
14.22	0.968	394.1	100,010	1,001	227.6	1	28.96
0.4912	0.03342	13.61	345.7	34.57	7.858	0.0345	1
0.01934	0.001316	0.536	13.61	1.361	0.310	0.00136	0.0394
0.1934	0.01316	5.358	136.1	13.61	3.10	0.0136	0.394
0.0145	0.000987	0.4012	10.21	1.021	0.2321	0.00102	0.0295
14.504	0.987	401.9	10,210	1021	232.1	1.02	29.53
0.000145	0.00001	0.00402	0.102	0.0102	0.00232	0.00001	0.000295
0.14504	0.00987	4.019	102.07	10.207	2.321	0.0102	0.295
145.04	9.869	4019	102,074	10,207	2321	10.2	295.3

mm Hg (Torr)	cm Hg	mbar	bar	Pa (Nm ²)	kPa	MPa
51.715	5.17	68.95	0.0689	6895	6.895	0.0069
760	76	1013	1.013	101,325	101.3	0.1013
1.866	0.187	2.488	0.00249	248.8	0.249	0.00025
0.0735	0.00735	0.098	0.000098	9.8	0.0098	0.00001
0.735	0.0735	0.98	0.00098	98	0.098	0.0001
3.232	0.323	4.31	0.00431	431	0.431	0.00043
735.6	73.56	980.7	0.981	98,067	98.07	0.0981
25.4	2.54	33.86	0.0339	3386	3.386	0.00339
1	.1	1.333	0.001333	133.3	0.1333	0.000133
10	1	13.33	0.01333	1333	1.333	0.00133
0.75	0.075	1	0.001	100	0.1	0.0001
750	75	1000	1	100,000	100	0.1
0.0075	0.00075	0.01	0.00001	1	0.001	0.000001
7.5	0.75	10	0.01	1,000	1	0.001
7500	750	10,000	10	1,000,000	1,000	1

To use this chart:

1. Find the column with the units you want to convert from.
2. Move down that column until you find the "1".
3. Staying in the same row, move horizontally to the column with the units you are converting to.
4. Multiply the number in that box by the amount you are changing from to get the converted value.



With almost 70 years of experience, WIKAI Instrument, LP is the leading global manufacturer of pressure and temperature measurement instrumentation, producing more than 43 million pressure gauges, diaphragm seals, pressure transmitters, thermometers and other instruments annually. WIKAI's extensive product line, including mechanical and electronic instruments, provides measurement solutions for any application in a large variety of industries. A global leader in lean manufacturing and instrumentation experience, WIKAI also offers a broad selection of stock and custom instrumentation as well as dedicated services to provide customers with the right solutions, at the right time, wherever they need us.



Mini-Siphon

910.24



All-Welded System

M93X.D1

WIKAI Instrument, LP
Pressure and Temperature Measurement
1000 Wiegand Boulevard • Lawrenceville, GA 30043
Toll Free (888) WIKAI-USA (888-945-2872)
Tel (770) 513-8200 • Fax (770) 338-5118
info@wika.com • www.wika.com

C009 - 5,000 Rev.3 4/13

